



T-1³/₄ (5mm) Ultra Bright AS AlInGaP LED Lamps

LTL2F3KRK/KEK/KHK/KAK/KFK/KYK/KSK	8degree
LTL2H3KRK/KEK/KHK/KAK/KFK/KYK/KSK	15degree
LTL2P3KRK/KEK/KHK/KAK/KFK/KYK/KSK	22degree
LTL2R3KRK/KEK/KHK/KAK/KFK/KYK/KSK	30degree

Features

- High luminous intensity output.
- Low power consumption.
- High efficiency.
- Versatile mounting on P.C. board or panel.
- I.C. Compatible/low current requirements.
- Popular T-13/4 diameter.

Description

The source color devices are made with Aluminum Indium Gallium Phosphide on Gallium Arsenide light emitting diode.

The devices are made with water clear epoxy package. And with 8,15,22 and 30 degrees of viewing angle.

Application

Available for half-outdoor and outdoor application.

- Message sign.
- Traffic sign.
- Automotive.

Package Dimensions

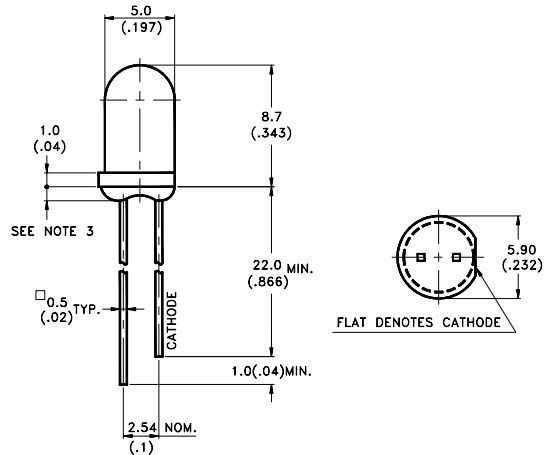

Notes:

1. All dimensions are in millimeters (inches).
2. Tolerance is $\pm 0.25\text{mm}$ (.010") unless otherwise noted.
3. Protruded resin under flange is 1.0mm (.04") max.
4. Lead spacing is measured where the leads emerge from the package.
5. Specifications are subject to change without notice.

Devices

Part No. LTL	Lens	Source Color
2F3KRK / 2H3KRK 2P3KRK / 2R3KRK	Water Clear	AllInGaP Super Red
2F3KEK / 2H3KEK 2P3KEK / 2R3KEK	Water Clear	AllInGaP Red
2F3KHK / 2H3KHK 2P3KHK / 2R3KHK	Water Clear	AllInGaP Red Orange
2F3KAK / 2H3KAK 2P3KAK / 2R3KAK	Water Clear	AllInGaP Red Orange
2F3KFK / 2H3KFK 2P3KFK / 2R3KFK	Water Clear	AllInGaP Yellow Orange
2F3KYK / 2H3KYK 2P3KYK / 2R3KYK	Water Clear	AllInGaP Amber Yellow
2F3KSK / 2H3KSK 2P3KSK / 2R3KSK	Water Clear	AllInGaP Yellow

ULTRA BRIGHT LAMPS & CLUSTER & CHMSL

Absolute Maximum Ratings at Ta=25°C

Parameter	Super Red	Red	Red Orange	Red Orange	Yellow Orange	Amber Yellow	Yellow	Unit
Power Dissipation	75	75	75	75	75	75	75	mW
Peak Forward Current (1/10 Duty Cycle, 0.1ms Pulse Width)	160	160	160	160	160	160	160	mA
Continuous Forward Current	30	30	30	30	30	30	30	mA
Derating Linear From 50°C	0.4	0.4	0.4	0.4	0.4	0.4	0.4	mA/°C
Reverse Voltage	5	5	5	5	5	5	5	v
Operating Temperature Range	-40°C to + 100°C							
Storage Temperature Range	-55°C to + 100°C							
Lead Soldering Temperature [1.6mm(.063") From Body]	260°C for 5 Seconds							

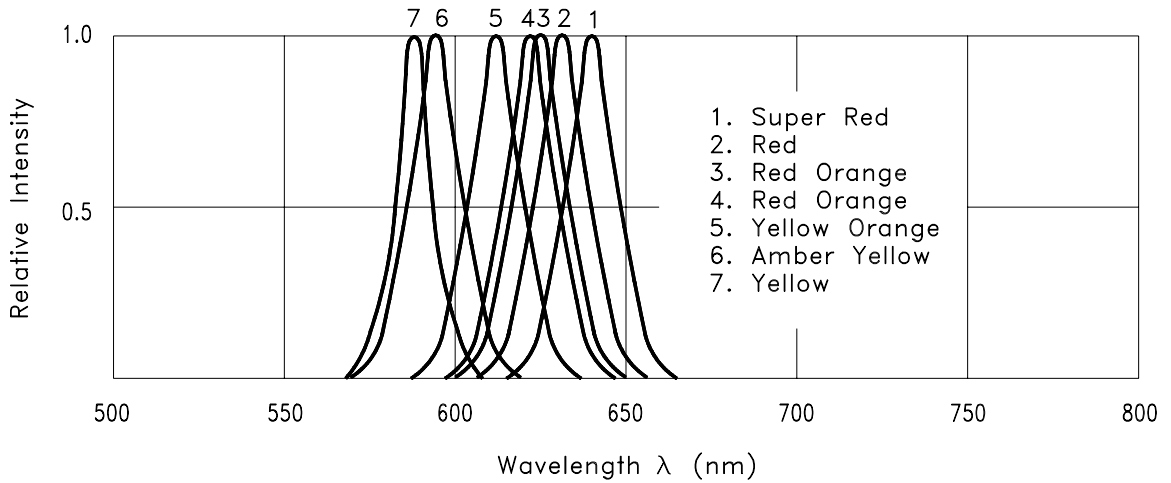

Fig.1 Relative Intensity vs. Wavelength

Electrical / Optical Characteristics and Curves at Ta= 25°C

Parameter	Symbol	Part No. LTL	Min.	Typ.	Max.	Unit	Test Condition
Luminous Intensity	I _v	2F3KRK	1000	2600		mcd	I _F =20mA Note 1 Note 2
		2F3KEK	1000	3600			
		2F3KHK	1000	3600			
		2F3KAK	1000	3600			
		2F3KFK	1000	3600			
		2F3KYK	1000	3600			
		2F3KSK	1000	3600			
Peak Emission Wavelength	λ _P	2F3KRK		639		nm	Measurement @ peak (Fig.1)
		2F3KEK		632			
		2F3KHK		624			
		2F3KAK		621			
		2F3KFK		611			
		2F3KYK		595			
		2F3KSK		588			
Dominant Wavelength	λ _d	2F3KRK		631		nm	Note 5
		2F3KEK		624			
		2F3KHK		618			
		2F3KAK		615			
		2F3KFK		605			
		2F3KYK		592			
		2F3KSK		587			
Spectral Line Half-Width	Δλ	2F3KRK		20		nm	
		2F3KEK		20			
		2F3KHK		18			
		2F3KAK		18			
		2F3KFK		17			
		2F3KYK		15			
		2F3KSK		15			
Forward Voltage	V _F	2F3KRK		2.0	2.4	V	I _F =20mA
		2F3KEK		2.05	2.4		
		2F3KHK		2.05	2.4		
		2F3KAK		2.05	2.4		
		2F3KFK		2.05	2.4		
		2F3KYK		2.05	2.4		
		2F3KSK		2.05	2.4		
Viewing Angle	2θ _{1/2}			8		deg	Note 2 (Fig.5)
Reverse Current	I _R				100	μA	V _R =5V
Capacitance	C			40		pF	V _F =0 f=1MHZ

Notes:

- Luminous intensity is measured with a light sensor and filter combination that approximates the CIE eye-response curve.
- Luminous intensity rank classified products support two ranks.
- θ_{1/2} is the off-axis angle at which the luminous intensity is half the axial luminous intensity.
- I_v classification code is marked on each packing bag.
- The dominant wavelength, λ_d is derived from the CIE chromaticity diagram and represents the single wavelength which defines the color of the device.

Electrical / Optical Characteristics and Curves at Ta= 25°C

Parameter	Symbol	Part No. LTL	Min.	Typ.	Max.	Unit	Test Condition
Luminous Intensity	I _v	2H3KRK	560	1300		mcd	I _F =20mA Note 1 Note 2
		2H3KEK	560	1700			
		2H3KHK	560	1700			
		2H3KAK	560	1700			
		2H3KFK	560	1700			
		2H3KYK	560	1700			
		2H3KSK	560	1700			
Peak Emission Wavelength	λ _P	2H3KRK		639		nm	Measurement @ peak (Fig.1)
		2H3KEK		632			
		2H3KHK		624			
		2H3KAK		621			
		2H3KFK		611			
		2H3KYK		595			
		2H3KSK		588			
Dominant Wavelength	λ _d	2H3KRK		631		nm	Note 5
		2H3KEK		624			
		2H3KHK		618			
		2H3KAK		615			
		2H3KFK		605			
		2H3KYK		592			
		2H3KSK		587			
Spectral Line Half-Width	Δλ	2H3KRK		20		nm	
		2H3KEK		20			
		2H3KHK		18			
		2H3KAK		18			
		2H3KFK		17			
		2H3KYK		15			
		2H3KSK		15			
Forward Voltage	V _F	2H3KRK		2.0	2.4	V	I _F =20mA
		2H3KEK		2.05	2.4		
		2H3KHK		2.05	2.4		
		2H3KAK		2.05	2.4		
		2H3KFK		2.05	2.4		
		2H3KYK		2.05	2.4		
		2H3KSK		2.05	2.4		
Viewing Angle	2θ _{1/2}			15		deg	Note 2 (Fig.5)
Reverse Current	I _R				100	μA	V _R =5V
Capacitance	C			40		pF	V _F =0 f=1MHz

Notes:

- Luminous intensity is measured with a light sensor and filter combination that approximates the CIE eye-response curve.
- Luminous intensity rank classified products support two ranks.
- θ_{1/2} is the off-axis angle at which the luminous intensity is half the axial luminous intensity.
- I_v classification code is marked on each packing bag.
- The dominant wavelength, λ_d is derived from the CIE chromaticity diagram and represents the single wavelength which defines the color of the device.

Electrical / Optical Characteristics and Curves at Ta= 25°C

Parameter	Symbol	Part No. LTL	Min.	Typ.	Max.	Unit	Test Condition
Luminous Intensity	I _v	2P3KRK	320	800		mcd	I _F =20mA Note 1 Note 2
		2P3KEK	320	1000			
		2P3KHK	320	1000			
		2P3KAK	320	1000			
		2P3KFK	320	1000			
		2P3KYK	320	1000			
		2P3KSK	320	1000			
Peak Emission Wavelength	λ _P	2P3KRK		639		nm	Measurement @ peak (Fig.1)
		2P3KEK		632			
		2P3KHK		624			
		2P3KAK		621			
		2P3KFK		611			
		2P3KYK		595			
		2P3KSK		588			
Dominant Wavelength	λ _d	2P3KRK		631		nm	Note 5
		2P3KEK		624			
		2P3KHK		618			
		2P3KAK		615			
		2P3KFK		605			
		2P3KYK		592			
		2P3KSK		587			
Spectral Line Half-Width	Δλ	2P3KRK		20		nm	
		2P3KEK		20			
		2P3KHK		18			
		2P3KAK		18			
		2P3KFK		17			
		2P3KYK		15			
		2P3KSK		15			
Forward Voltage	V _F	2P3KRK		2.0	2.4	V	I _F =20mA
		2P3KEK		2.05	2.4		
		2P3KHK		2.05	2.4		
		2P3KAK		2.05	2.4		
		2P3KFK		2.05	2.4		
		2P3KYK		2.05	2.4		
		2P3KSK		2.05	2.4		
Viewing Angle	2θ _{1/2}			22		deg	Note 2 (Fig.5)
Reverse Current	I _R				100	μA	V _R =5V
Capacitance	C			40		pF	V _F =0 f=1MHZ

Notes:

- Luminous intensity is measured with a light sensor and filter combination that approximates the CIE eye-response curve.
- Luminous intensity rank classified products support two ranks.
- θ_{1/2} is the off-axis angle at which the luminous intensity is half the axial luminous intensity.
- I_v classification code is marked on each packing bag.
- The dominant wavelength, λ_d is derived from the CIE chromaticity diagram and represents the single wavelength which defines the color of the device.

Electrical / Optical Characteristics and Curves at Ta= 25°C

Parameter	Symbol	Part No. LTL	Min.	Typ.	Max.	Unit	Test Condition
Luminous Intensity	I _v	2R3KRK	180	500		mcd	I _F =20mA Note 1 Note 2
		2R3KEK	180	700			
		2R3KHK	180	700			
		2R3KAK	180	700			
		2R3KFK	180	700			
		2R3KYK	180	700			
		2R3KSK	180	700			
Peak Emission Wavelength	λ _P	2R3KRK		639		nm	Measurement @ peak (Fig.1)
		2R3KEK		632			
		2R3KHK		624			
		2R3KAK		621			
		2R3KFK		611			
		2R3KYK		595			
		2R3KSK		588			
Dominant Wavelength	λ _d	2R3KRK		631		nm	Note 5
		2R3KEK		624			
		2R3KHK		618			
		2R3KAK		615			
		2R3KFK		605			
		2R3KYK		592			
		2R3KSK		587			
Spectral Line Half-Width	Δλ	2R3KRK		20		nm	
		2R3KEK		20			
		2R3KHK		18			
		2R3KAK		18			
		2R3KFK		17			
		2R3KYK		15			
		2R3KSK		15			
Forward Voltage	V _F	2R3KRK		2.0	2.4	V	I _F =20mA
		2R3KEK		2.05	2.4		
		2R3KHK		2.05	2.4		
		2R3KAK		2.05	2.4		
		2R3KFK		2.05	2.4		
		2R3KYK		2.05	2.4		
		2R3KSK		2.05	2.4		
Viewing Angle	2θ _{1/2}			30		deg	Note 2 (Fig.5)
Reverse Current	I _R				100	μ A	V _R =5V
Capacitance	C			40		pF	V _F =0 f=1MHz

Notes:

- Luminous intensity is measured with a light sensor and filter combination that approximates the CIE eye-response curve.
- Luminous intensity rank classified products support two ranks.
- θ_{1/2} is the off-axis angle at which the luminous intensity is half the axial luminous intensity.
- I_v classification code is marked on each packing bag.
- The dominant wavelength, λ_d is derived from the CIE chromaticity diagram and represents the single wavelength which defines the color of the device.

Typical Electrical / Optical Characteristic Curves (25°C Ambient Temperature Unless Otherwise Noted)

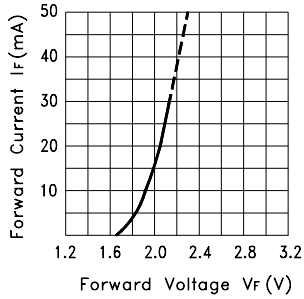

Fig.2 Forward Current vs. Forward Voltage

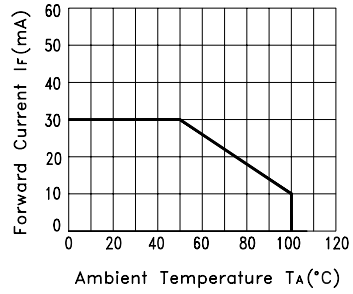

Fig.3 Forward Current Derating Curve

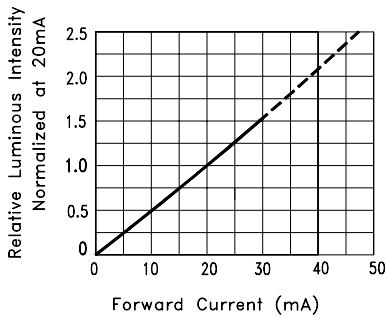

Fig.4 Relative Luminous Intensity vs. Forward Current

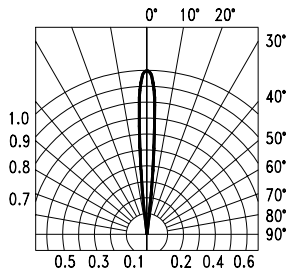

Fig.5-1 Spatial Distribution

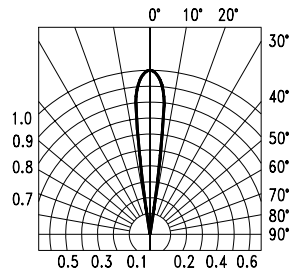

Fig.5-2 Spatial Distribution

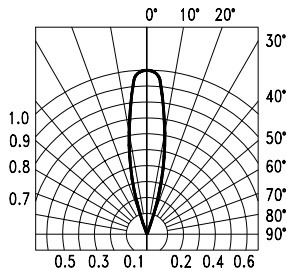

Fig.5-3 Spatial Distribution

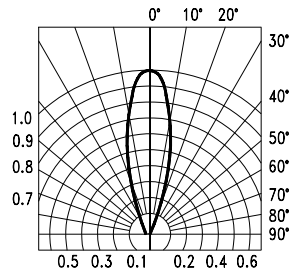

Fig.5-4 Spatial Distribution

ULTRA BRIGHT
LAMPS & CLUSTER
& CHMSL