

Numeric LED

■ 1-digit

Type	Character height (mm)	Type of display	Common pins	Radiation color						Outline dimensions			
				P Red	D Red	S Sunset orange	H Yellow	E Yellow-green	K Green	Page	Figure		
Mold Type	8.0		A	GL9P030	GL9D030	GL9S030	GL9H030	GL9E030	GL9K030	→	10		
			K	GL8P030	GL8D030	GL8S030	GL8H030	GL8E030	GL8K030				
	10.16		A	GL9P040	GL9D040	GL9S040	GL9H040	GL9E040	GL9K040		→	9	
			K	GL8P040	GL8D040	GL8S040	GL8H040	GL8E040	GL8K040				
	14.12		A	GL9P156	GL9D156	GL9S156	GL9H156	GL9E156	GL9K156	→	8		
			K	GL8P156	GL8D156	GL8S156	GL8H156	GL8E156	GL8K156				
	25.4			A		GL9D100	GL9S100	GL9H100	GL9E100			→	4
				K		GL8D100	GL8S100	GL8H100	GL8E100				
45.0		A			GL9D18			GL9E18		→	2		
		K			GL8D18			GL8E18					
Page for ratings/characteristics diagrams				→	→	→	→	→	→				

*1 A: Anode common K: Cathode common

■ Absolute Maximum Ratings(Mold Type) Figures shown below are values per segment.

(Ta=25°C)

Character height (mm)	Radiation color	Forward current I _F (mA)	Peak forward current ^{*1} I _{FM} (mA)	Derating factor (mA/°C)		Reverse voltage V _R (V)	Operating temperature T _{opr.} (°C)	Storage temperature T _{stg.} (°C)
				DC	Pulse			
6.0	P	10	50	0.18	0.91	5	-30 to +70	-40 to +80
6.2		(15) ^{*2}						
7.6	D	20	50	0.36	0.91	5	-30 to +70	-40 to +80
8.0								
8.4	S	20	50	0.36	0.91	5	-30 to +70	-40 to +80
10.16	H	20	50	0.36	0.91	5	-30 to +70	-40 to +80
14.12	E	15	50	0.27	0.91	5	-30 to +70	-40 to +80
20.32 (common)	K	15	50	0.27	0.91	5	-30 to +70	-40 to +80
25.4	D	20	50	0.36	0.91	6	-30 to +70	-40 to +80
	S	20	50	0.36	0.91	6	-30 to +70	-40 to +80
	H	20	50	0.36	0.91	6	-30 to +70	-40 to +80
	E	20	50	0.36	0.91	6	-30 to +70	-40 to +80

*1 Duty ratio=1/10, Pulse width=0.1ms

*2 (): figures for GL8/9P040, GL8/9P056, GL8/9P156, GL6/7P220

■ Absolute Maximum Ratings(Substrate Type) Figures shown below are values per segment.

(Ta=25°C)

Character height (mm)	Radiation color	Forward current I _F (mA)	Peak forward current ^{*1} I _{FM} (mA)	Derating factor (mA/°C)		Reverse voltage V _R (V)	Operating temperature T _{opr.} (°C)	Storage temperature T _{stg.} (°C)
				DC	Pulse			
7.6	P	15	50	0.15	1.11	5	-10 to +60	-20 to +70
	D							
10.0	E	15	50	0.15	1.11	5	-10 to +60	-20 to +70
	D	30	50	0.67	1.11	5	-10 to +60	-20 to +70
45.0	E	20	50	0.44	1.11	5	-10 to +60	-20 to +70

*1 Duty ratio=1/10, Pulse width=0.1ms

Numeric LED

■ **Luminous Intensity(Unit:mcd)** Figures shown below are values per segment.

(Ta=25°C)

Type	Digit	Character height (mm)	Radiation color		P	D	S	H	E	K
			Series		Red	Red	Sunset orange	Yellow	Yellow-green	Green
			Anode common	Cathode common	TYP	TYP	TYP	TYP	TYP	TYP
Mold Type	1-digit	8.0	GL9□030	GL8□030	1.0	4.14	1.5	2.6	2.5	1.56
		10.16	GL9□040	GL8□040	0.8	3.0	4.3	2.5	3.0	1.75
		14.12	GL9□156	GL8□156	1.0	4.0	3.9	4.5	3.0	2.1
		25.4	GL9□100	GL8□100		6.38	4.8	4.6	3.5	
	2-digits	6.0	GL7□202	GL6□202	0.3			0.35	1.8	
		10.16	GL7□201	GL6□201	0.8	3.8		4.1	3.5	
		14.12	GL7□220	GL6□220	1.0	4.0	4.5	4.5	3.0	
	3-digits	8.0	GL3□306	GL3□305	1.0	2.80			2.85	
		6.2	GL3□412	GL3□411	0.25			0.6	0.7	
	4-digits	8.0	GL3□422	GL3□421	0.66		1.25		2.2	
8.4		GL3□404	GL3□403	0.3	0.8			2.0		
7.6		GL3□508D	GL3□507D	0.3						
Substrate Type	1-digit	45.0	GL9□18	GL8□18		6.4			3.4	
	2-digits	7.6	GL7□208U	GL6□208U	0.2	0.4			0.6	
		10.0	GL3□202	GL3□201	0.4	0.6			1.0	
			GL7□206U	GL6□206U	0.4	0.6		1.0		

* As for current conditions, refer to I_F in electro-optical characteristics

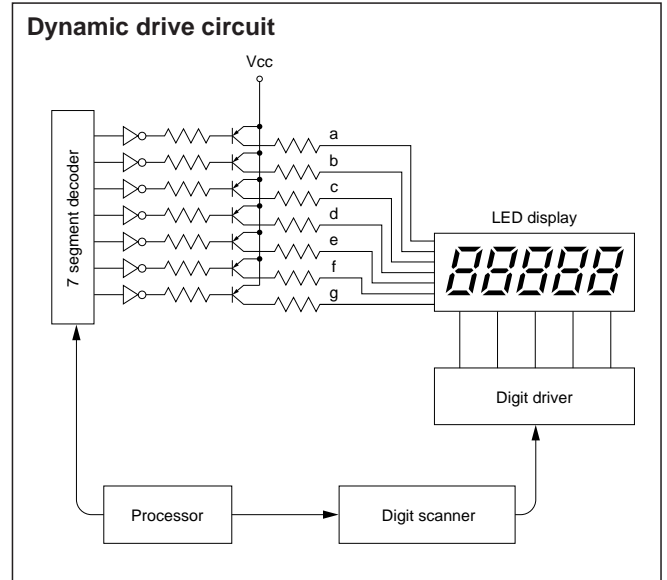
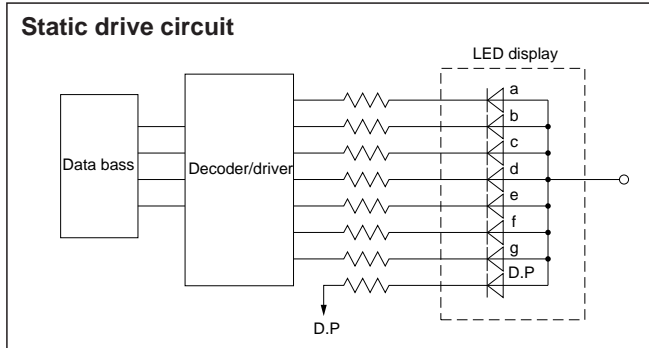

(Notice) • In the absence of confirmation by device specification sheets, SHARP takes no responsibility for any defects that may occur in equipment using any SHARP devices shown in catalogs, data books, etc. Contact SHARP in order to obtain the latest device specification sheets before using any SHARP device.
 (Internet) • Data for sharp's optoelectronic/power device is provided for internet.(Address <http://www.sharp.co.jp/ecg/>)

Numeric LED Characteristics Diagrams

P series

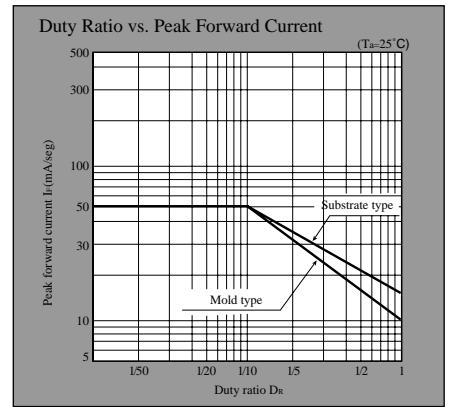
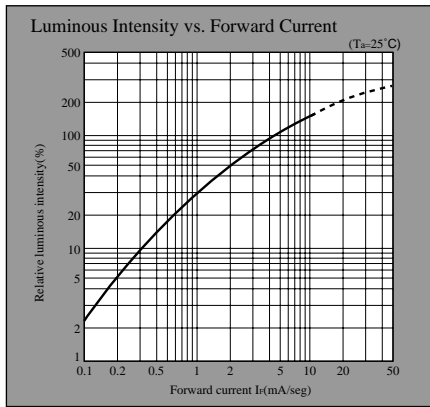
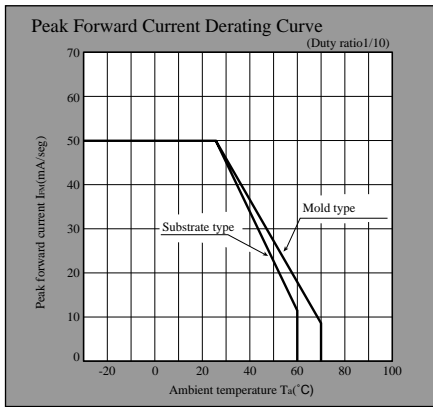
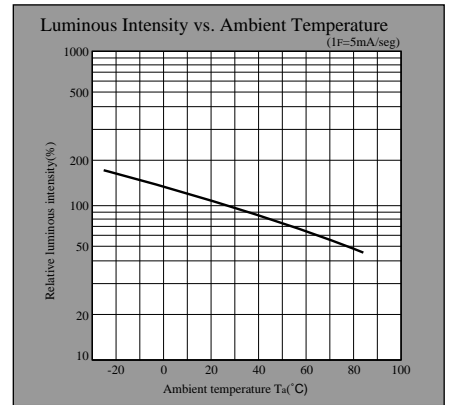
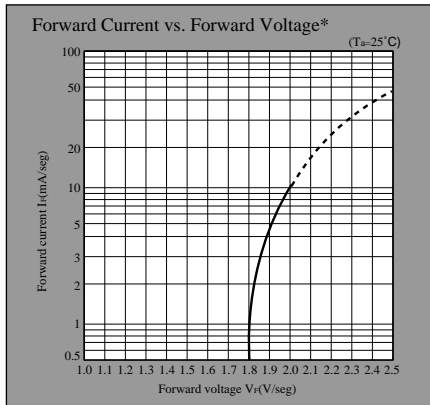
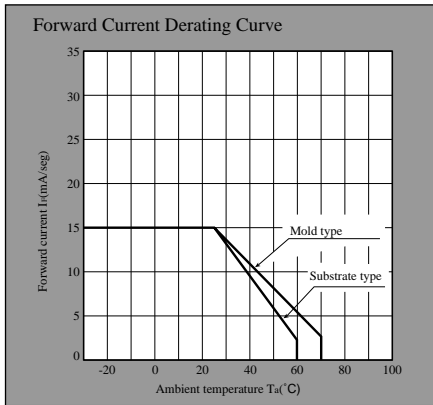

U series

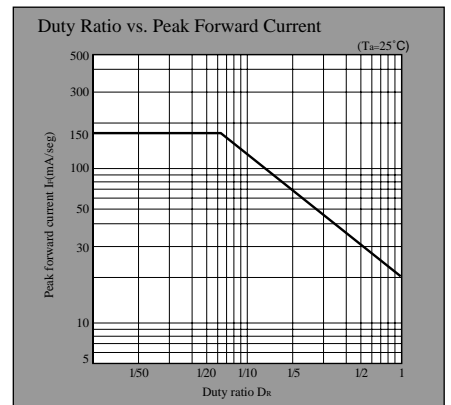
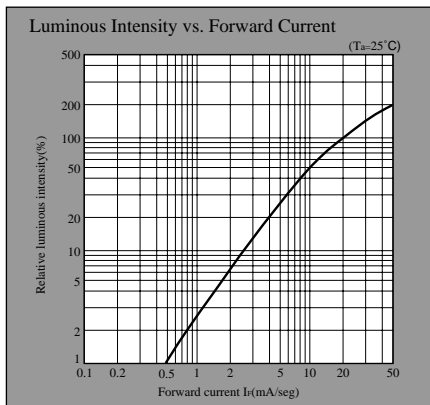
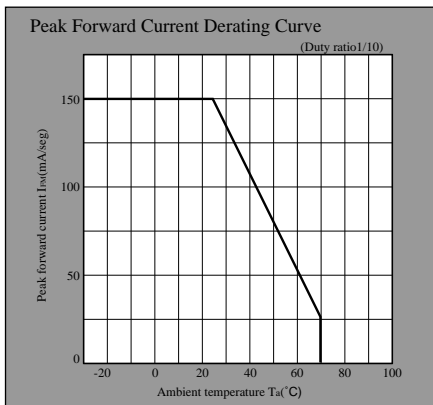
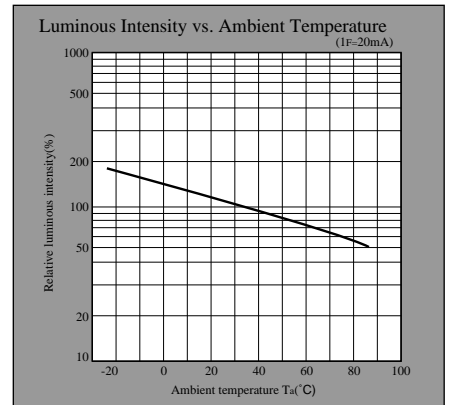
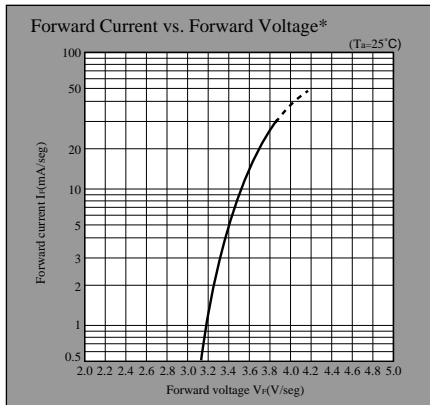
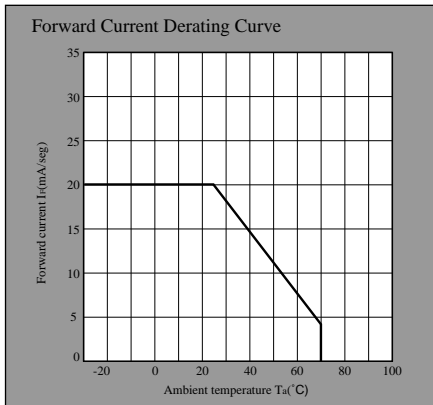

* In case of 25.4/38.1/76.0mm: value per 1segment 1chip

Numeric LED Characteristics Diagrams

T series

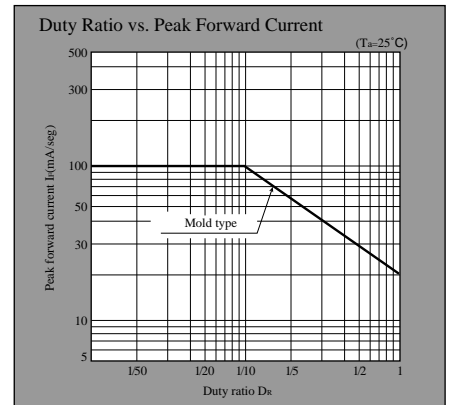
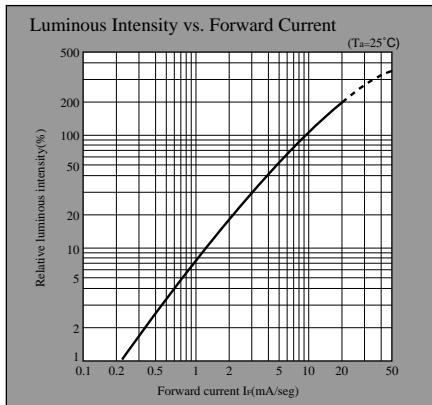
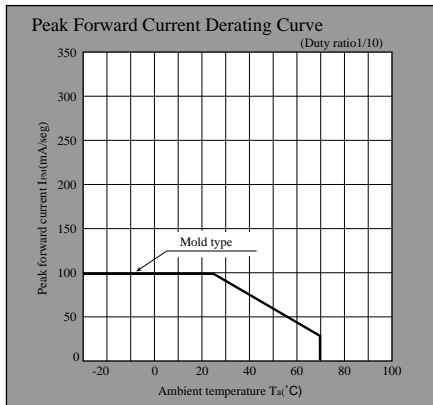
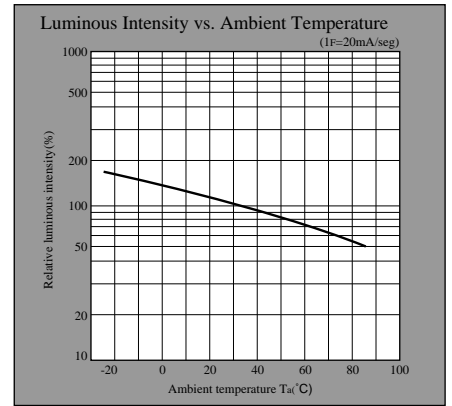
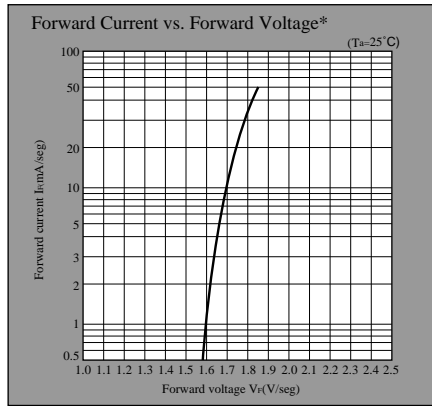
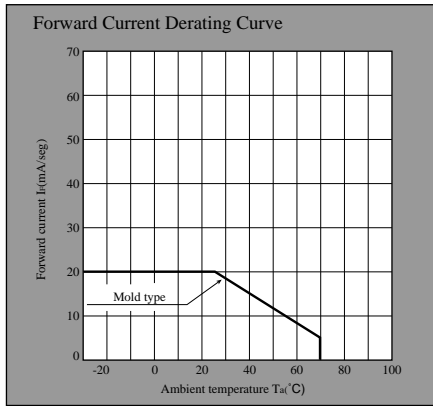

* In case of 25.4mm: value per 1segment 1chip

D series

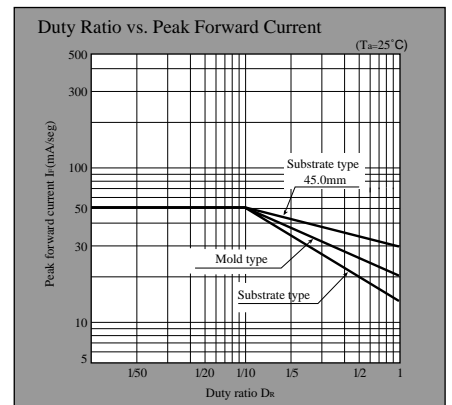
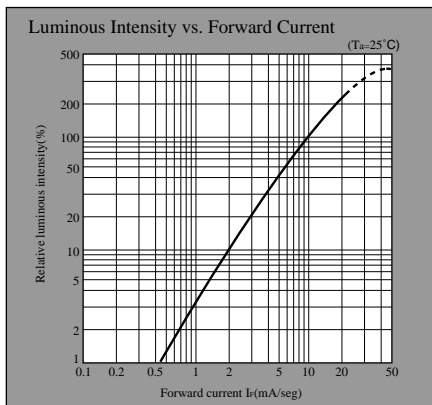
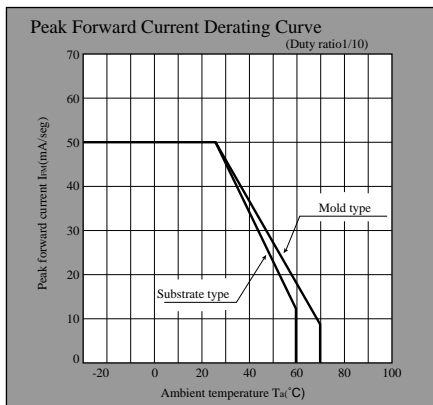
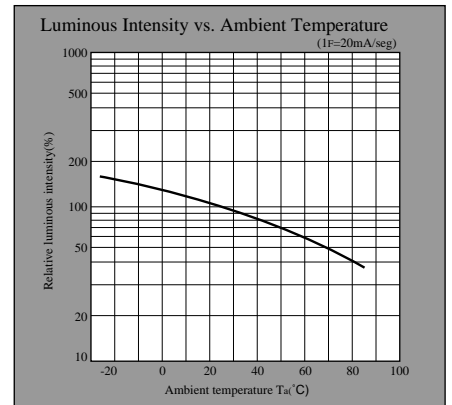
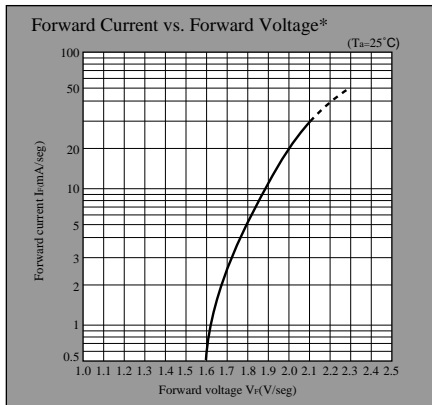
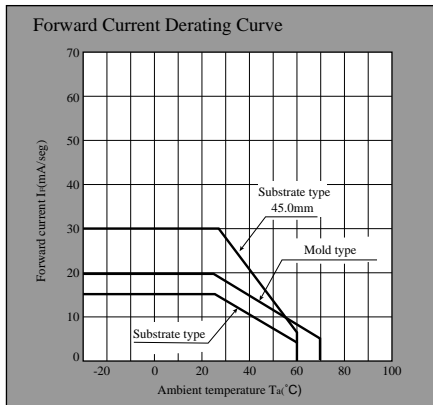

* In case of 25.4/45.0mm: value per 1segment 1chip

(Notice) • In the absence of confirmation by device specification sheets, SHARP takes no responsibility for any defects that may occur in equipment using any SHARP devices shown in catalogs, data books, etc. Contact SHARP in order to obtain the latest device specification sheets before using any SHARP device.
 (Internet) • Data for sharp's optoelectronic/power device is provided for internet.(Address <http://www.sharp.co.jp/ecg/>)

Numeric LED Characteristics Diagrams

S series

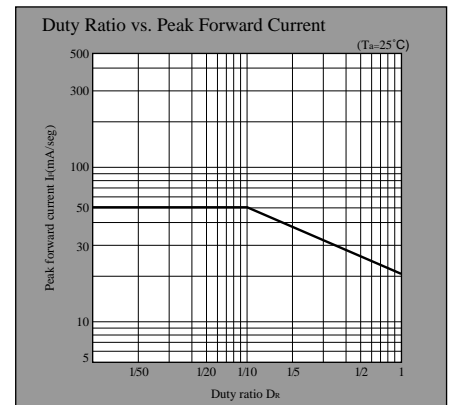
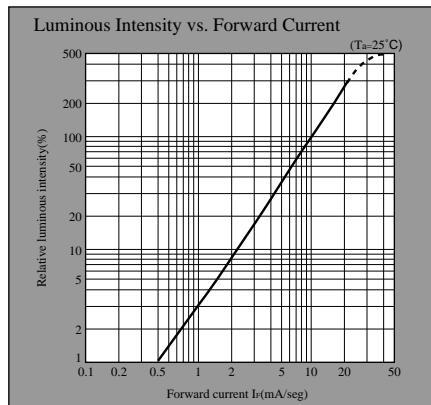
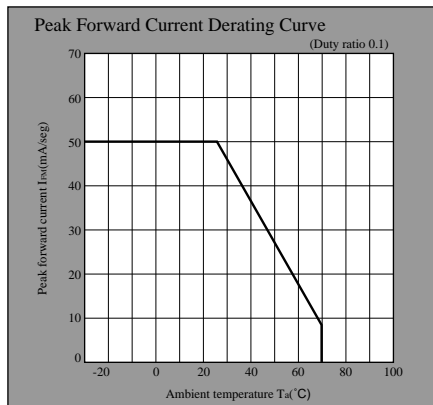
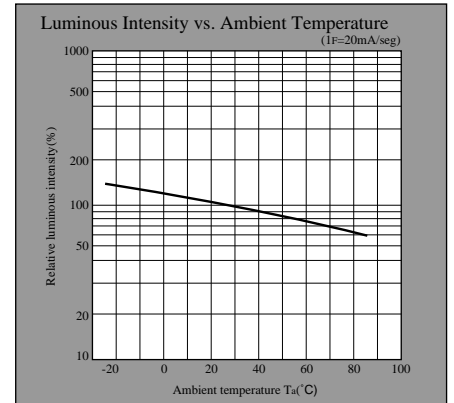
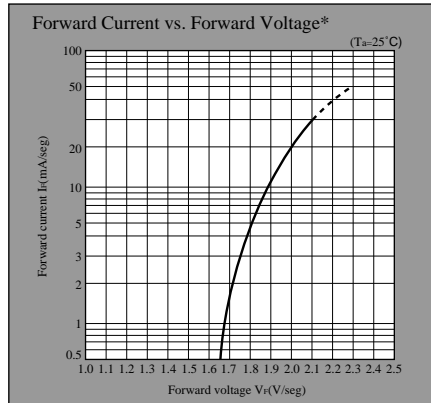
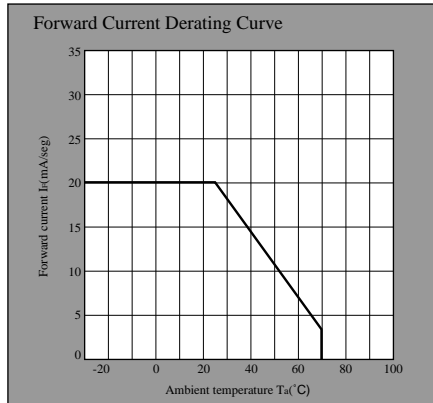

* In case of 25.4mm: value per 1segment 1chip

H series

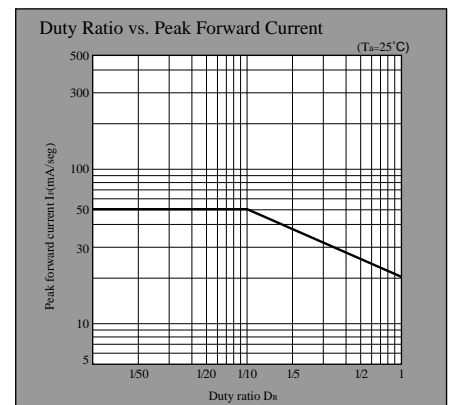
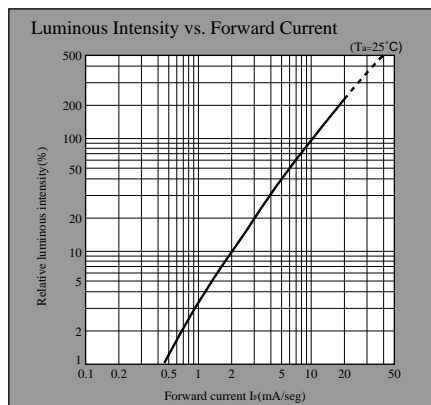
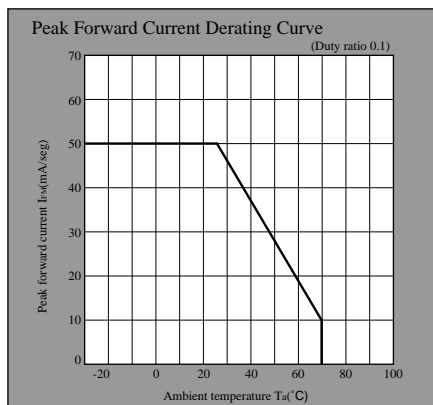
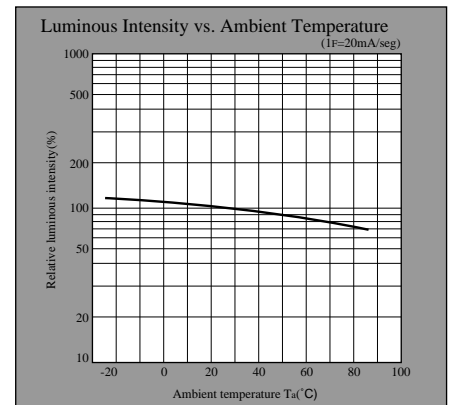
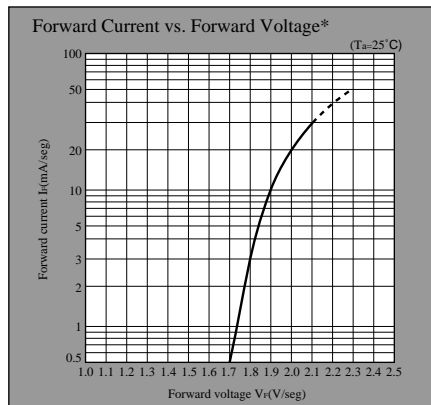
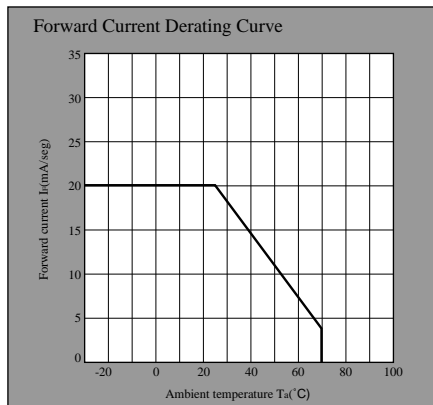

* In case of 25.4mm: value per 1segment 1chip

(Notice) • In the absence of confirmation by device specification sheets, SHARP takes no responsibility for any defects that may occur in equipment using any SHARP devices shown in catalogs, data books, etc. Contact SHARP in order to obtain the latest device specification sheets before using any SHARP device.
 (Internet) • Data for sharp's optoelectronic/power device is provided for internet.(Address <http://www.sharp.co.jp/ecg/>)

Numeric LED Characteristics Diagrams

E series

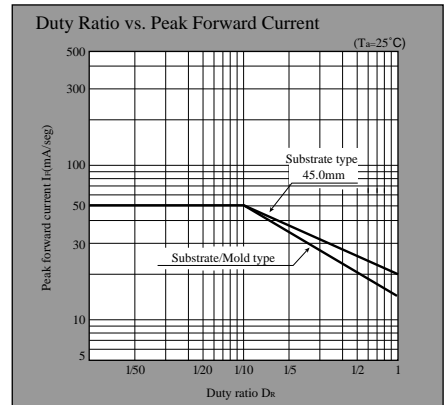
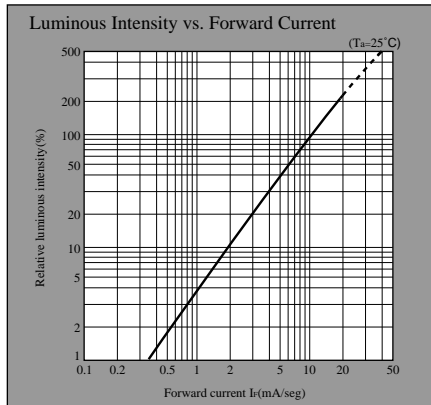
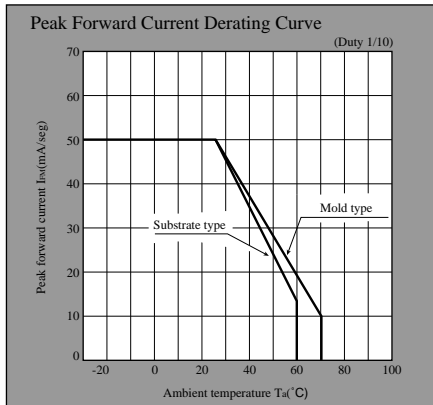
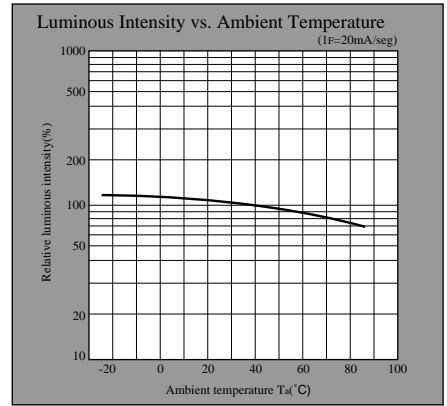
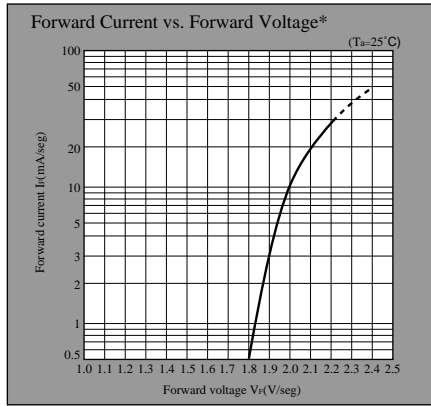
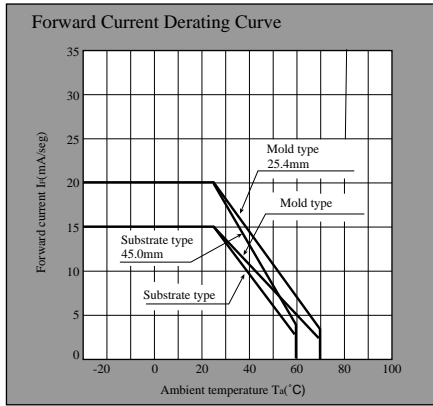

* In case of 25.4/45.0mm: value per 1segment 1chip

K series

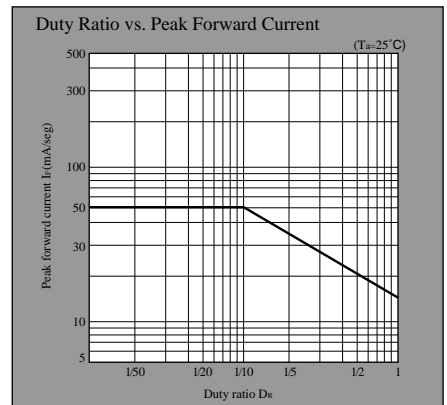
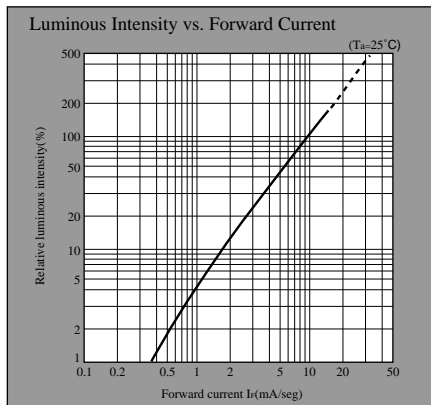
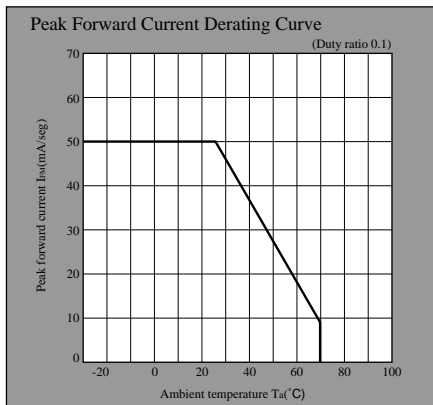
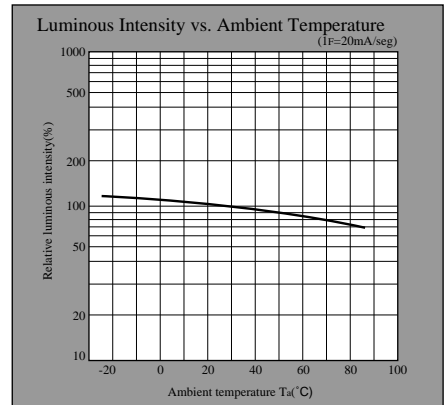
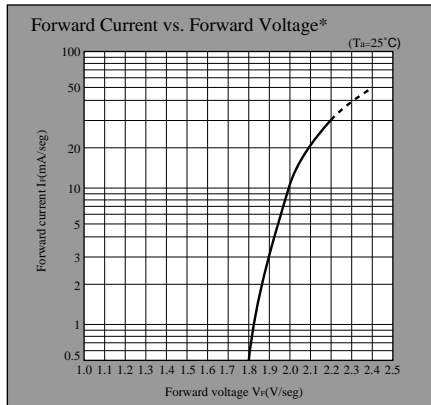
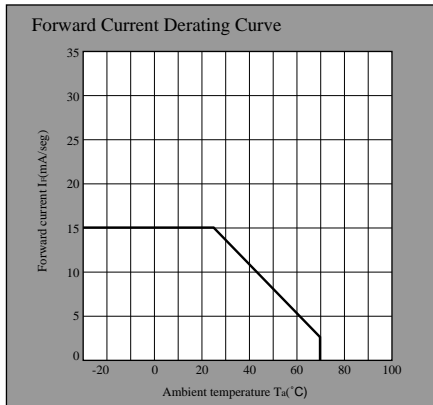

(Notice) • In the absence of confirmation by device specification sheets, SHARP takes no responsibility for any defects that may occur in equipment using any SHARP devices shown in catalogs, data books, etc. Contact SHARP in order to obtain the latest device specification sheets before using any SHARP device.
 (Internet) • Data for sharp's optoelectronic/power device is provided for internet.(Address <http://www.sharp.co.jp/ecg/>)

Numeric LED Outline Dimensions(Unit:mm)

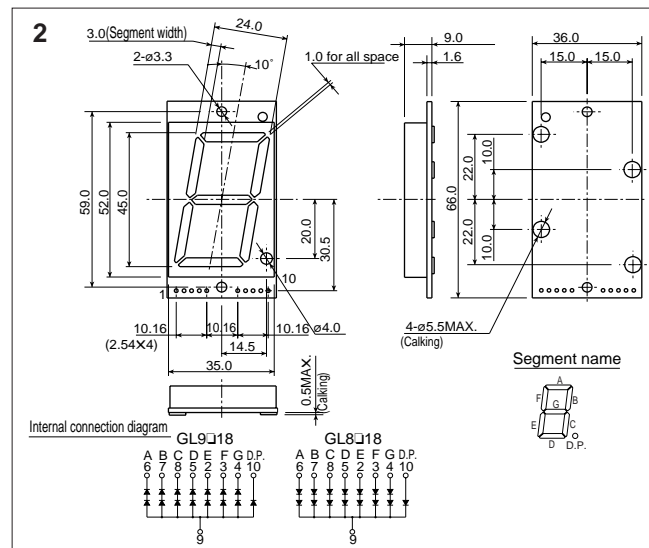
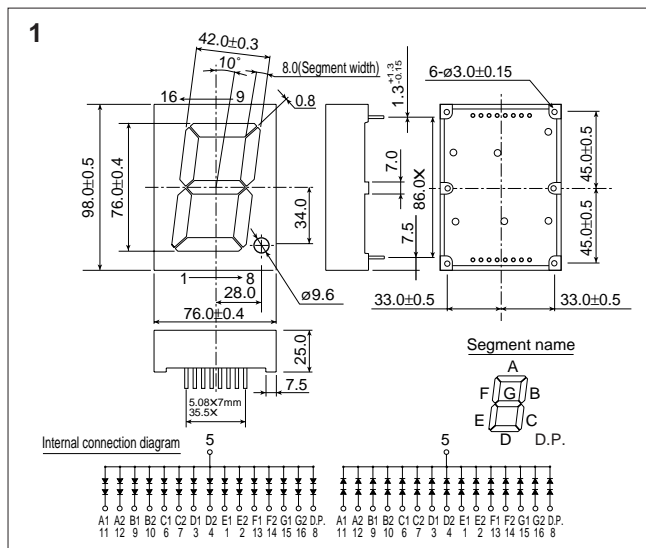

Numeric LED Outline Dimensions(Unit:mm)

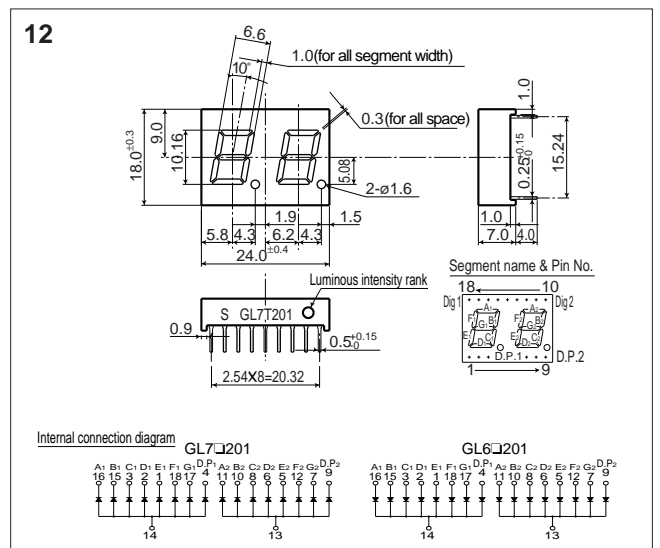
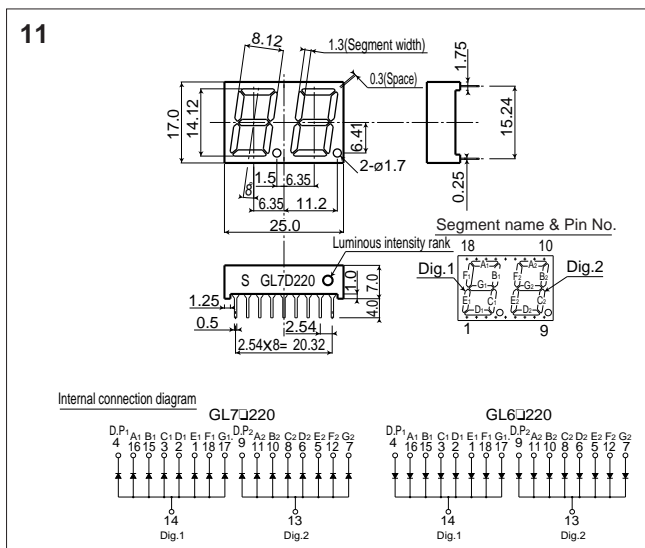
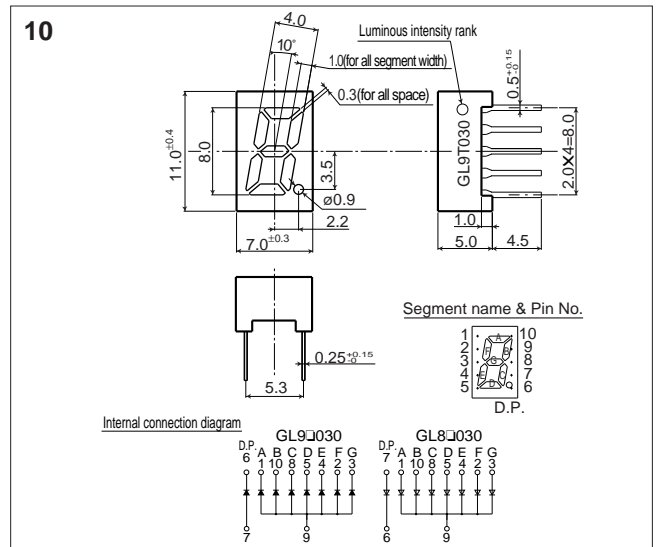
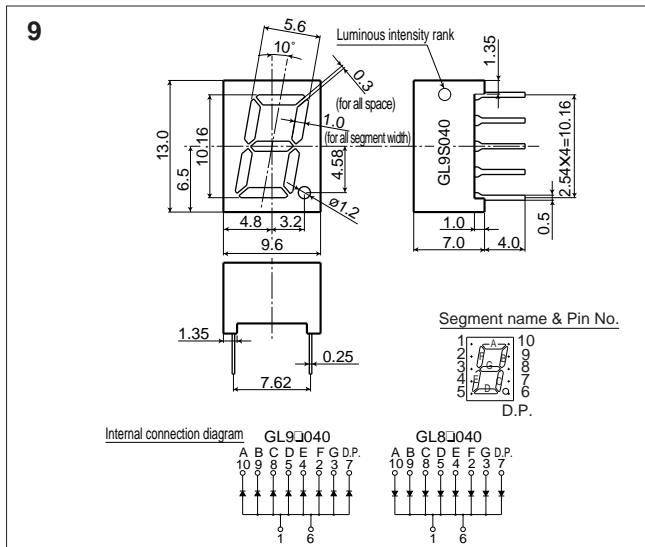
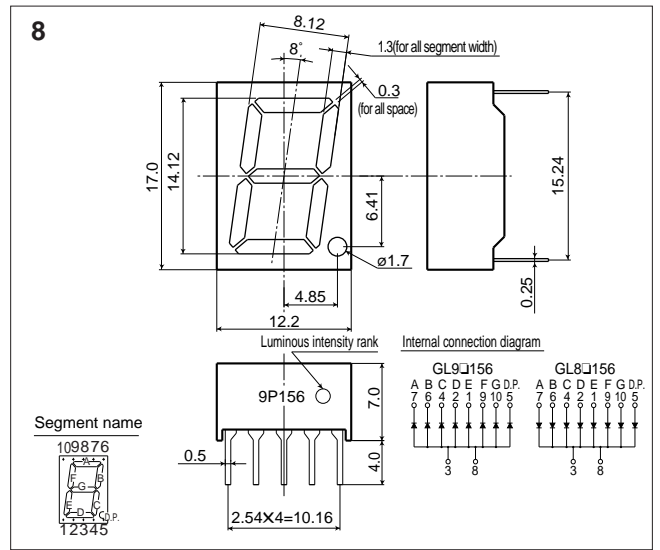
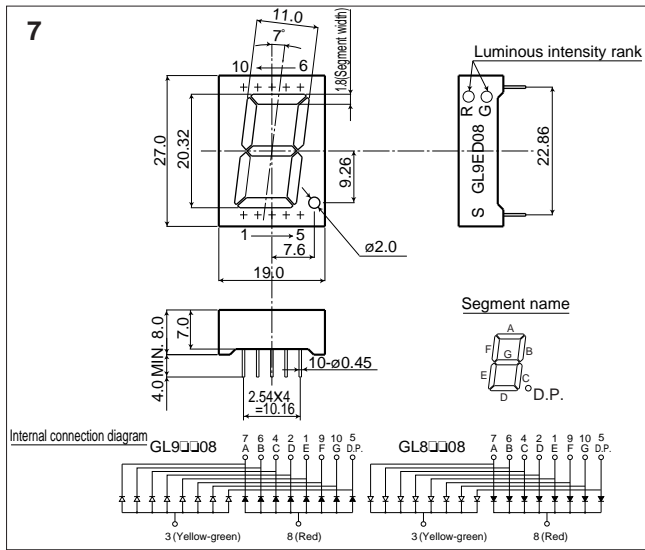

(Notice) • In the absence of confirmation by device specification sheets, SHARP takes no responsibility for any defects that may occur in equipment using any SHARP devices shown in catalogs, data books, etc. Contact SHARP in order to obtain the latest device specification sheets before using any SHARP device.
 (Internet) • Data for sharp's optoelectronic/power device is provided for internet.(Address <http://www.sharp.co.jp/ecg/>)