

TOSHIBA PHOTO INTERRUPTER INFRARED LED + PHOTO TRANSISTOR

TLP832

HOME ELECTRONICS EQUIPMENT SUCH AS VCRS AND CD PLAYERS

OA EQUIPMENT SUCH AS COPIERS, PRINTERS, AND FACSIMILES

AUTOMATIC SERVICING EQUIPMENT SUCH AS COMMODITY AND
TICKET VENDING MACHINES

VARIOUS POSITION DETECTION SENSOR

The TLP832 photointerrupter consists of a GaAs infrared LED and a Si phototransistor.

Housed in a short lead package, this device is ideal for automatic mounting.

- Printed wiring board direct mounting type (with a locating pin)
- Short lead type enabling automatic mounting
 - : Lead length $3.4 \pm 0.3\text{mm}$
- Board thickness : 1mm or less
- Gap : 5mm
- Resolution : Slit width 0.5mm
- High current transfer ratio : $I_C / I_F = 5\%$ (min)
- High response speed : $t_r, t_f = 15\mu\text{s}$ (typ.)
- Detector side is of visible light cut type.
- Material of the package : Polybutylene terephthalate (UL94V-0, Black color)

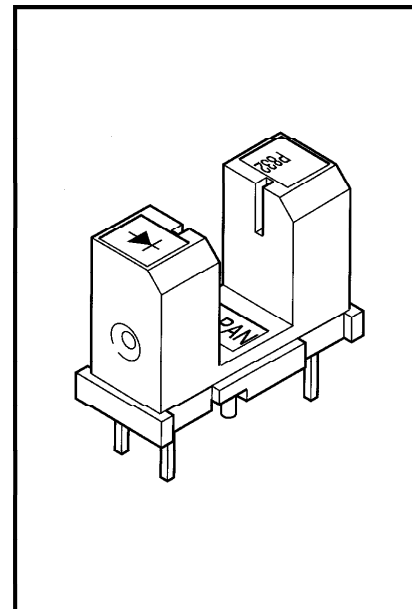

JEDEC	—
EIAJ	—
TOSHIBA	11-14F1

Weight : 0.58g (typ.)

961001EBC2

● TOSHIBA is continually working to improve the quality and the reliability of its products. Nevertheless, semiconductor devices in general can malfunction or fail due to their inherent electrical sensitivity and vulnerability to physical stress. It is the responsibility of the buyer, when utilizing TOSHIBA products, to observe standards of safety, and to avoid situations in which a malfunction or failure of a TOSHIBA product could cause loss of human life, bodily injury or damage to property. In developing your designs, please ensure that TOSHIBA products are used within specified operating ranges as set forth in the most recent products specifications. Also, please keep in mind the precautions and conditions set forth in the TOSHIBA Semiconductor Reliability Handbook.

● Gallium arsenide (GaAs) is a substance used in the products described in this document. GaAs dust and fumes are toxic. Do not break, cut or pulverize the product, or use chemicals to dissolve them. When disposing of the products, follow the appropriate regulations. Do not dispose of the products with other industrial waste or with domestic garbage.

● The products described in this document are subject to foreign exchange and foreign trade control laws.

● The information contained herein is presented only as a guide for the applications of our products. No responsibility is assumed by TOSHIBA CORPORATION for any infringements of intellectual property or other rights of the third parties which may result from its use. No license is granted by implication or otherwise under any intellectual property or other rights of TOSHIBA CORPORATION or others.

● The information contained herein is subject to change without notice.

MAXIMUM RATINGS (Ta = 25°C)

CHARACTERISTIC		SYMBOL	RATING	UNIT
LED	Forward Current	I _F	50	mA
	Forward Current Derating (Ta > 25°C)	ΔI _F /°C	-0.33	mA/°C
	Reverse Voltage	V _R	5	V
DETECTOR	Collector-Emitter Voltage	V _{CEO}	35	V
	Emitter-Collector Voltage	V _{ECO}	5	V
	Collector Power Dissipation	P _C	75	mW
	Collector Power Dissipation Derating (Ta > 25°C)	ΔP _C /°C	-1	mW/°C
	Collector Current	I _C	50	mA
Operating Temperature		T _{opr}	-30~85	°C
Storage Temperature		T _{stg}	-40~100	°C
Soldering Temperature (5s)(Note 1)		T _{sol}	260	°C

Note 1 : At the location of 1.5mm from the resin package bottom

PRODUCT INDICATION

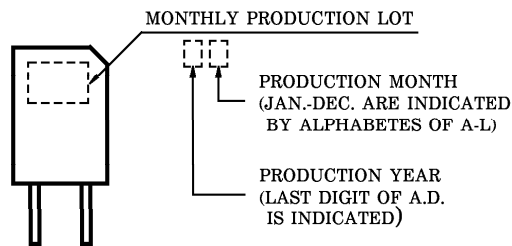

RECOMMENDED OPERATING CONDITIONS

CHARACTERISTIC	SYMBOL	MIN.	TYP.	MAX.	UNIT
Supply Voltage	V _{CC}	—	5	24	V
Forward Current	I _F	—	—	25	mA
Operating Temperature	T _{opr}	-10	—	75	°C

OPTO ELECTRICAL CHARACTERISTICS (Ta = 25°C)

CHARACTERISTIC		SYMBOL	TEST CONDITION	MIN.	TYP.	MAX.	UNIT
LED	Forward Voltage	V_F	$I_F = 10\text{mA}$	1.00	1.15	1.30	V
	Reverse Current	I_R	$V_R = 5\text{V}$	—	—	10	μA
	Peak Emission Wavelength	λ_P	$I_F = 10\text{mA}$	—	940	—	nm
DETECTOR	Dark Current	$I_D (I_{CEO})$	$V_{CE} = 24\text{V}, I_F = 0$	—	—	0.1	μA
	Peak Sensitivity Wavelength	λ_P		—	870	—	nm
COUPLED	Current Transfer Ratio	I_C / I_F	$V_{CE} = 2\text{V}, I_F = 10\text{mA}$	5	—	100	%
	Collector-Emitter Saturation Voltage	$V_{CE}(\text{sat})$	$I_F = 20\text{mA}, I_C = 0.5\text{mA}$	—	0.1	0.35	V
	Rise Time	t_r	$V_{CC} = 5\text{V}, I_C = 1\text{mA}, R_L = 1\text{k}\Omega$	—	15	50	μs
	Fall Time	t_f		—	15	50	

Note 2 : Switching time measurement circuit and waveform

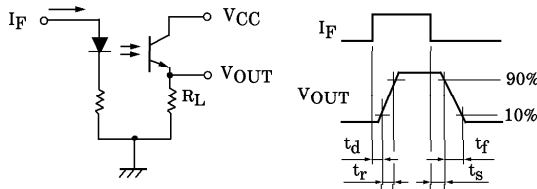

PRECAUTIONS

- When removing flux with chemicals after soldering, clean only the leads on the soldering side; do not dip the whole package for cleaning. Chemicals remaining on an LED or phototransistor light emitter or receiver, if any, would have a bad influence to the optical characteristics and it may severely lower the conversion efficiency.
- The environment to install the device should be determined carefully. Oil or chemicals may cause the package to be dissolved or cracked.
- The device should be mounted on an unwarped surface.
- Install this device as avoiding the disturbance light as possible. A visible light cut-off type phototransistor which blocks light with frequencies of 700nm or above is used. However, the device cannot block infrared light with a wavelength of 700nm or more, and it may do mistaken movements.
- The current transfer ratio is gradually lowered when infrared LED is powered. The efficiency deterioration by aging should be considered when designing the circuit.

OUTLINE : TOSHIBA

Unit : mm

() : REFERENCE VALUE

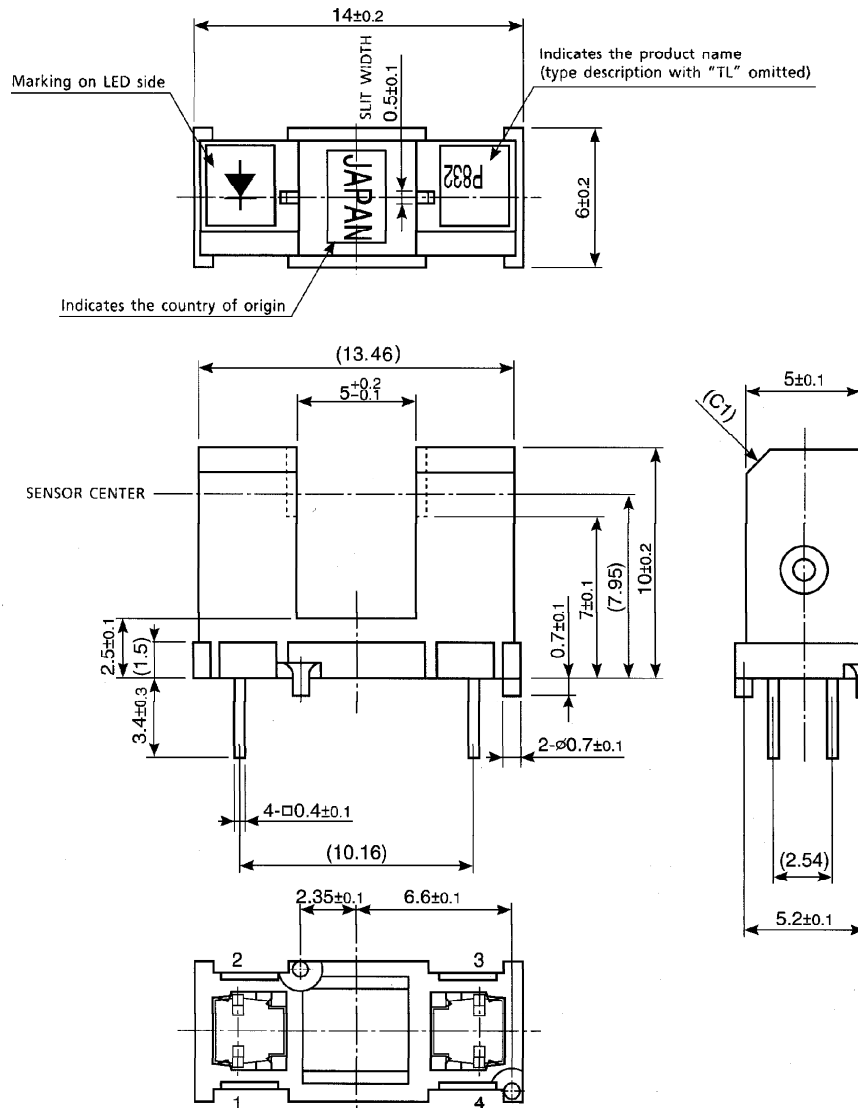

Weight : 0.58g (TYP.)

PIN CONNECTION

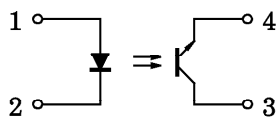

- 1. ANODE
- 2. CATHODE
- 3. COLLECTOR
- 4. EMITTER

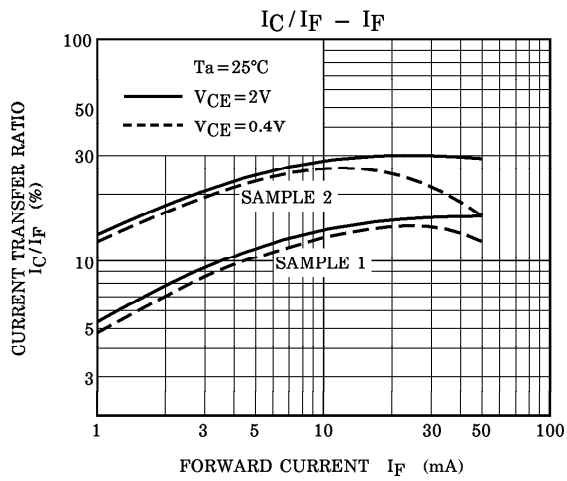
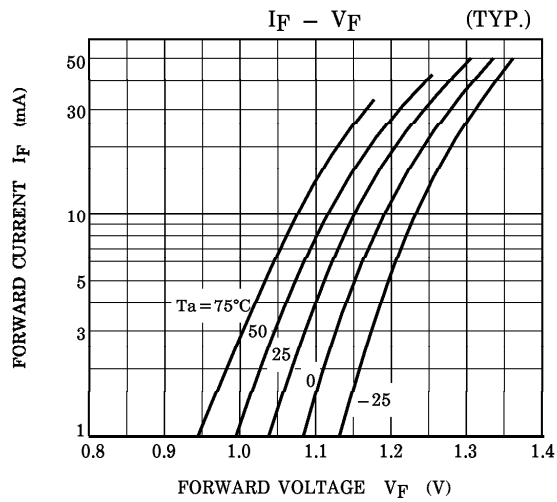
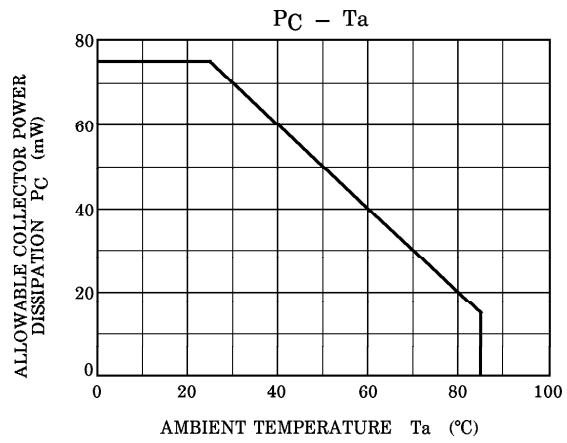
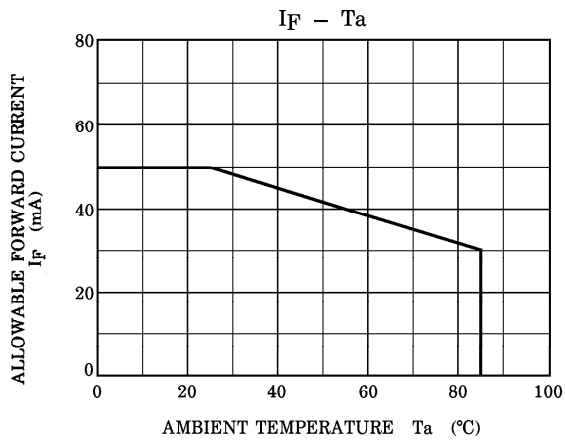

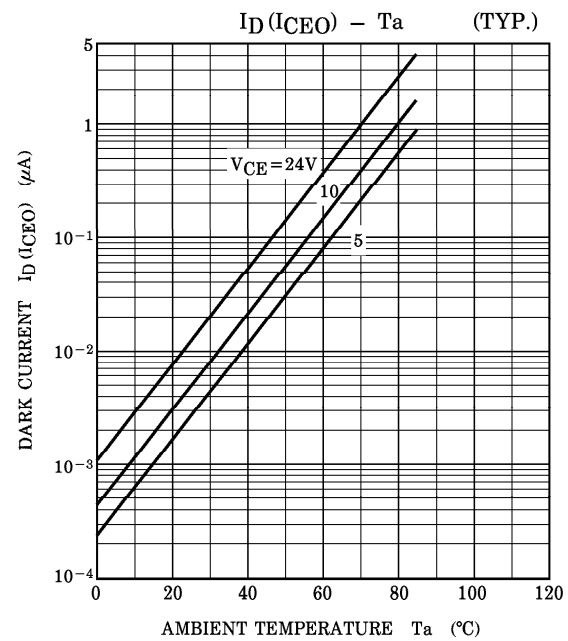
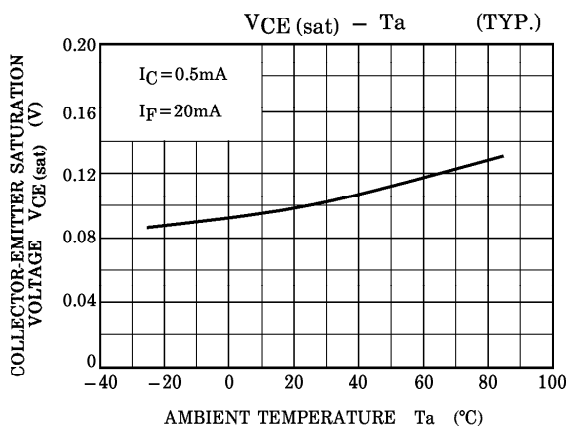
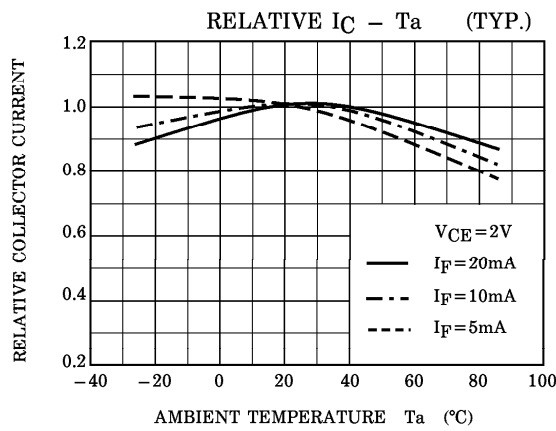
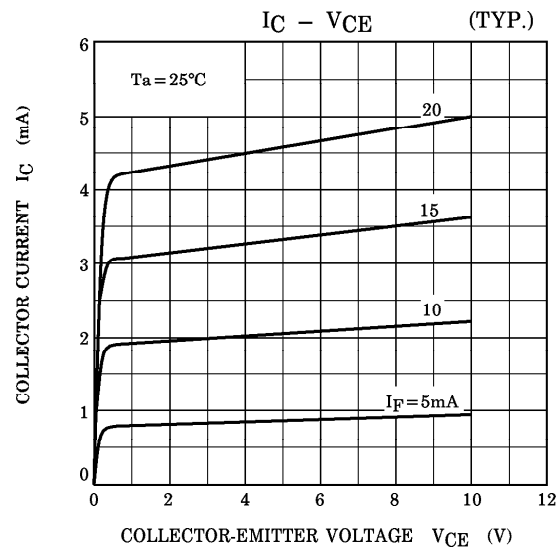
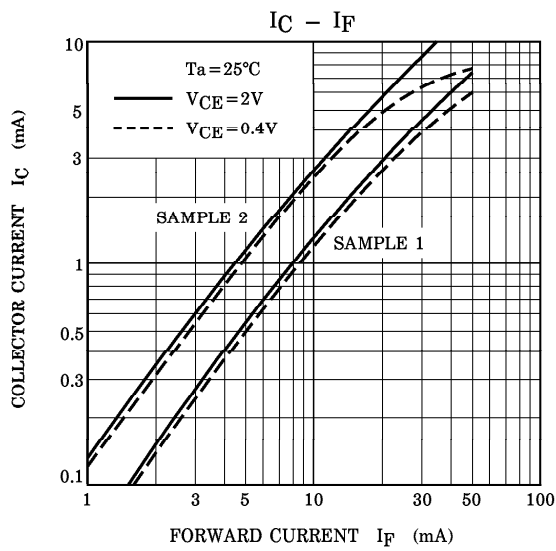

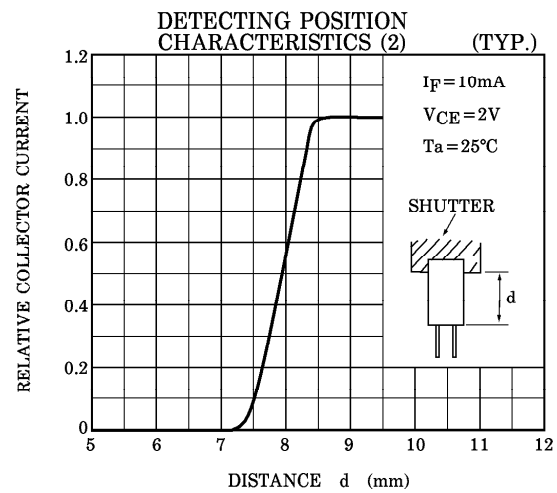
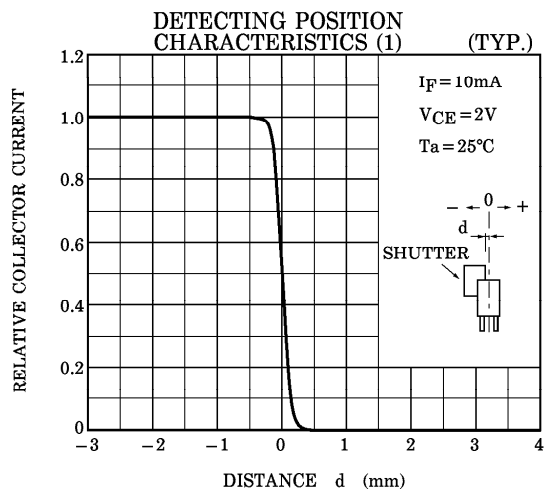
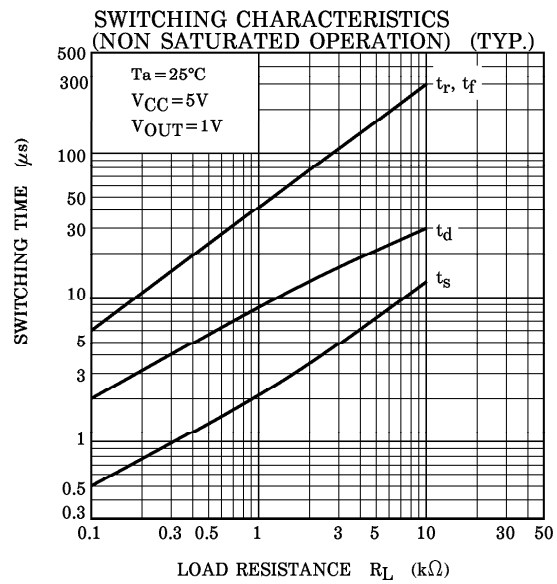
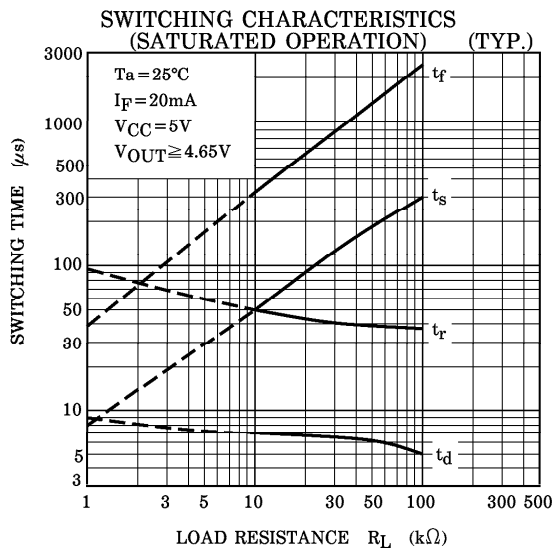

POSITIONING OF SHUTTER AND DEVICE

To operate correctly, make sure that the shutter and the device are positioned as shown in the figure below.

The slit pitch of the shutter must be set wider than the slit width of the device.
Determine the width taking the switching time into consideration.

