



Telecommunications Switch  
Optocoupler/1 Form A Relay

## DESCRIPTION

The TR115-F1 is a dual function circuit designed specifically as a telecommunications switch. It consists an optically isolated solid state relay separated from an optocoupler. The relay portion is composed of an LED on the input, optically coupled to a sensing circuit which drives two source-to-source DMOS transistors. The optocoupler portion of the package consists of two back-to-back LEDs that drive an output phototransistor. The flatpack package is ideal for PCMCIA-type applications.

## FEATURES

- Low input control current
- Function integration
- 20 ohms max on-resistance
- 120mA max continuous load current
- Flatpack package

## APPLICATIONS

- Telecom switching
- PCMCIA cards
- Fax/modem modules
- Set-top boxes
- DAA arrangements
- Hookswitch
- Loop current detect
- Pulse dialing

## OPTIONS/SUFFIXES

- -H High Output Isolation
- -TR Tape and Reel

## MAXIMUM RATINGS

PARAMETER	UNIT	MIN	TYP	MAX
Storage Temperature	°C	-55		125
Operating Temperature	°C	-40		85
Continuous Input Current	mA			40
Transient Input Current	mA			400
Reverse Input Control Voltage	V	6		
Output Power Dissipation	mW			500

## SCHEMATIC DIAGRAM

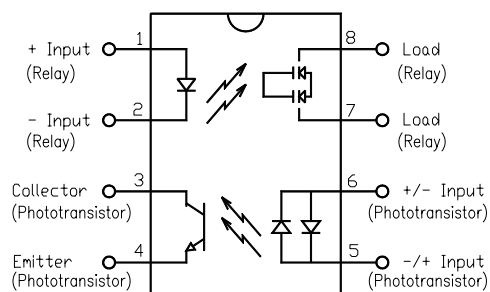

## APPROVALS

- BAPT CERTIFICATE #607835:  
BS EN 60950, BS EN 41003, BS EN 60065
- CSA CERTIFICATE #LR111581-1
- UL FILE #E90096



Telecommunications Switch  
Optocoupler/1 Form A Relay

**ELECTRICAL CHARACTERISTICS - 25°**

PARAMETER	UNIT	MIN	TYP	MAX	TEST CONDITIONS
<b>RELAY INPUT SPECIFICATIONS</b>					
LED Forward Voltage	V		1.2	1.5	If = 10mA
LED Reverse Voltage	V	6	12		Ir = 10uA
Turn-On Current	m A	5	2.5		Io = 120mA
Turn-Off Current	m A		0.5		
<b>RELAY OUTPUT SPECIFICATIONS</b>					
Blocking Voltage	V	400			Io = 10uA
Continuous Load Current	m A			120	If = 5mA
On-Resistance	Ω		17	20	Io = 120mA
Leakage Current	μ A		0.7	10	Vo = 400V
Output Capacitance	p F		25	50	Vo = 25V, f = 1.0MHz
Offset Voltage	m V			0.2	If = 5mA
Turn-On Time	m s		2	5	If = 5mA, Io = 120mA
Turn-Off Time	m s		0.5	1	If = 5mA, Io = 120mA
<b>PHOTOTRANSISTOR INPUT SPECIFICATIONS</b>					
LED Forward Voltage	V		1.2	1.5	If = 10mA
Turn-On Current	m A	2			Io = 0.5mA
<b>PHOTOTRANSISTOR OUTPUT SPECIFICATIONS</b>					
Breakdown Voltage	V	60			Io = 10uA
Leakage Current	n A			500	Vce = 20V
Collector-Emitter Capacitance	p F		6		Vce = 0V, f = 1.0kHz
Saturation Voltage	V			0.5	If = 5mA
Current Transfer Ratio	%	30	100	800	If = 2mA, Vce = 5V
<b>COUPLED SPECIFICATIONS</b>					
Isolation Voltage	V	2500			T = 1 minute
-H Suffix	V	3750			T = 1 minute
Isolation Resistance	G Ω	100			
Coupled Capacitance	p F			2	
Contact Transient Ratio	V / μ s	2000	7000		dV = 50V



Telecommunications Switch  
Optocoupler/1 Form A Relay

**PERFORMANCE DATA**

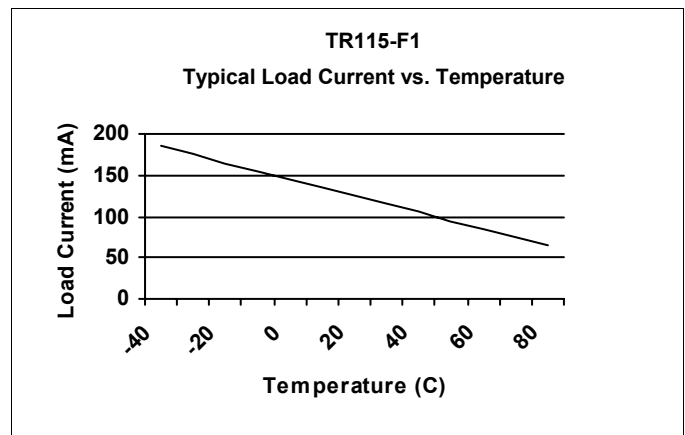
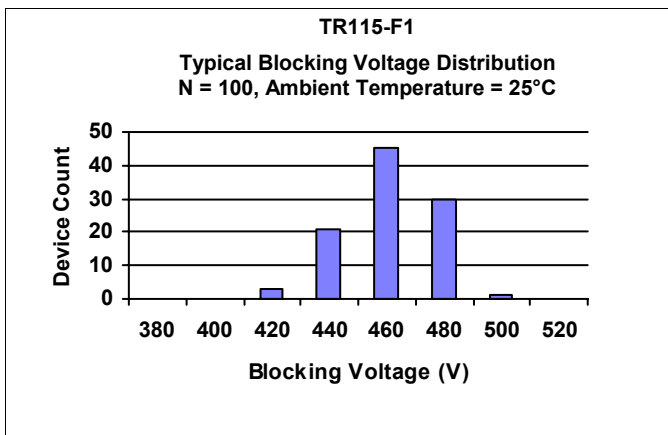
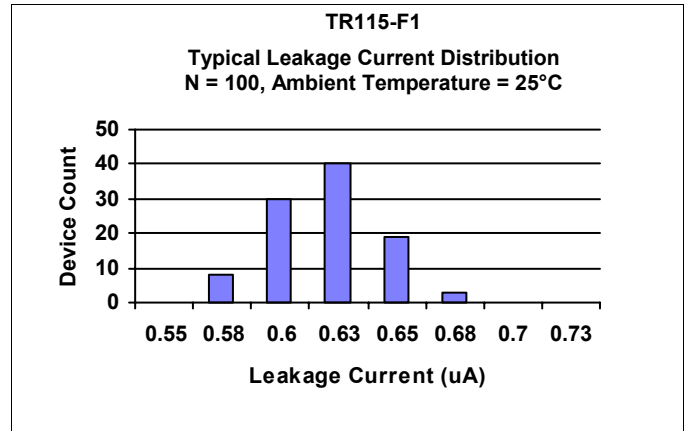
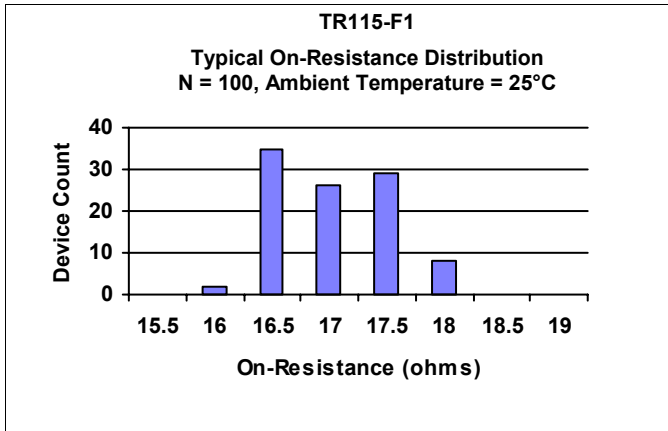
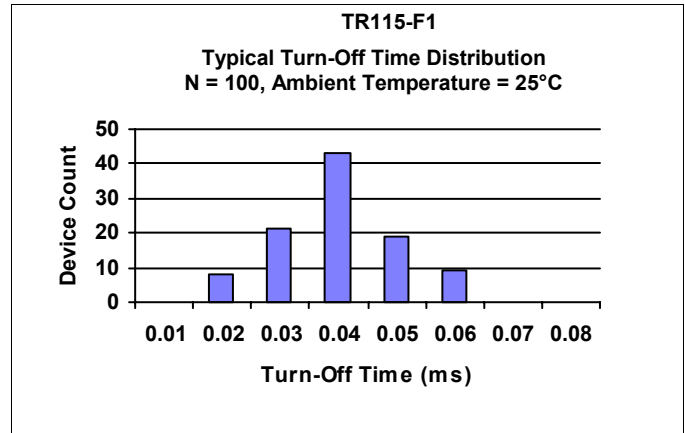
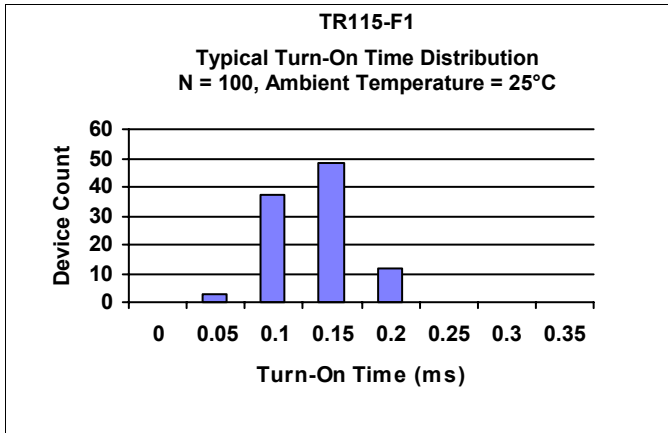



Telecommunications Switch  
Optocoupler/1 Form A Relay

**MECHANICAL DIMENSIONS**

**8 PIN FLATPACK PACKAGE**

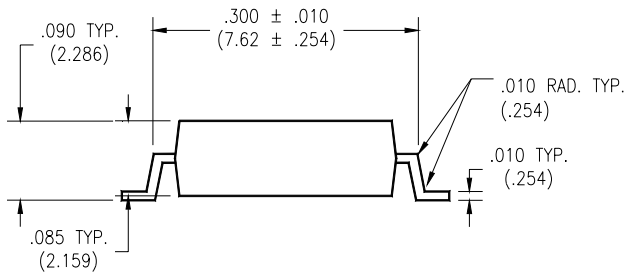

**END VIEW**

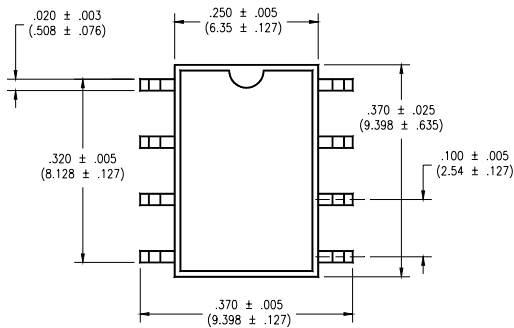

**TOP VIEW**

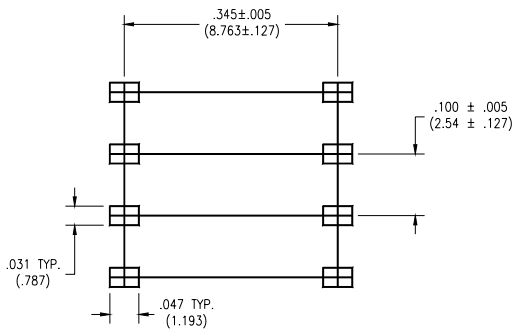

**BOTTOM VIEW**