

8M-BIT CMOS SYNCHRONOUS FAST STATIC RAM
256K-WORD BY 36-BIT
HSTL INTERFACE / REGISTER-REGISTER / LATE WRITE
Description

The μ PD4383362 is a 262,144 words by 36 bits synchronous static RAM fabricated with advanced CMOS technology using N-channel four-transistor memory cell.

The μ PD4383362 is suitable for applications which require synchronous operation, high-speed, low voltage, high-density memory and wide bit configuration, such as cache and buffer memory.

The μ PD4383362 is packaged in 100-pin plastic LQFP with a 1.4 mm package thickness for high density and low capacitive loading.

Features

- Fully synchronous operation
- HSTL Input / Output levels
- ★ • Fast clock access time : 3.8 ns / 133 MHz
- Asynchronous output enable control : /G
- Byte write control : /SBa (DQa1-9), /SBb (DQb1-9), /SBc (DQc1-9), /SBd (DQd1-9)
- Common I/O using three-state outputs
- Internally self-timed write cycle
- Late write with 1 dead cycle between Read-Write
- 3.3 V (Chip) / 1.5 V (I/O) supply
- 100-pin plastic LQFP package, 14 mm x 20 mm
- Sleep Mode : ZZ(Enables sleep mode, active high)

Ordering Information

Part number	Access time	Clock frequency	Package
★ μ PD4383362GF-A75	3.8 ns	133 MHz	100-PIN PLASTIC LQFP (14 x 20)

The information in this document is subject to change without notice. Before using this document, please confirm that this is the latest version.
 Not all devices/types available in every country. Please check with local NEC representative for availability and additional information.

Pin Configuration (Marking Side)

/xxx indicates active low signal.

100-PIN PLASTIC LQFP (14 x 20)

[μPD4383362GF]

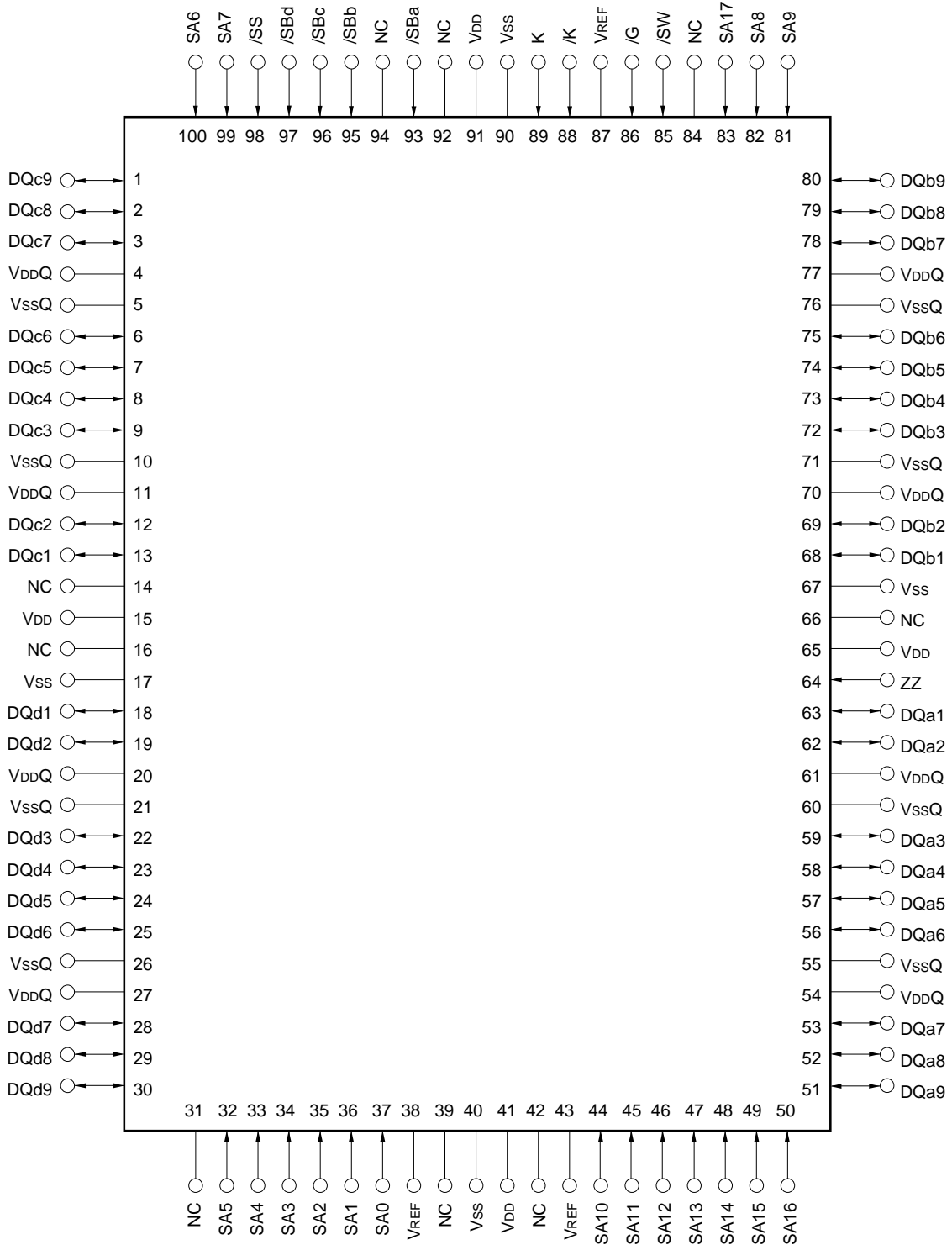

Remark Refer to Package Drawing for 1-pin index mark.

Pin Name and Functions

Pin name	Pin No.	Description
SA0 to SA17	37, 36, 35, 34, 33, 32, 100, 99, 82, 81, 44, 45, 46, 47, 48, 49, 50, 83	Synchronous Address Input
DQa1 to DQa9	63, 62, 59, 58, 57, 56, 53, 52, 51	Synchronous Data Input / Output
DQb1 to DQb9	68, 69, 72, 73, 74, 75, 78, 79, 80	
DQc1 to DQc9	13, 12, 9, 8, 7, 6, 3, 2, 1	
DQd1 to DQd9	18, 19, 22, 23, 24, 25, 28, 29, 30	
/SS	98	Synchronous Chip Select
/SW	85	Synchronous Byte Write Enable
/SBa ^{Note1}	93	Synchronous Byte "a" Write Enable
/SBb ^{Note1}	95	Synchronous Byte "b" Write Enable
/SBc ^{Note1}	96	Synchronous Byte "c" Write Enable
/SBd ^{Note1}	97	Synchronous Byte "d" Write Enable
/G	86	Asynchronous Output Enable
ZZ ^{Note2}	64	Asynchronous Sleep Mode
K, /K	89, 88	Main Clock Input
VDD	15, 41, 65, 91	Core Power Supply
VSS	17, 40, 67, 90	Ground
VDDQ	4, 11, 20, 27, 54, 61, 70, 77	Output Buffer Power Supply
VSSQ	5, 10, 21, 26, 55, 60, 71, 76	Output Buffer Ground
VREF	38, 43, 87	Input Reference
NC	14, 16, 31, 39, 42, 66, 84, 92, 94	No Connection

- Notes**
1. If Byte Write Operation is not used, Byte Write Pin (/SBa, /SBb, /SBc, /SBd) are to be tied to Vss.
 2. If Sleep Mode is not used, ZZ Pin is to be tied to Vss.

Remark This device only supports Single Differential Clock, R/R Mode.
 (R/R stands for Registered Input/Registered Output.)

Late Write Block Diagram

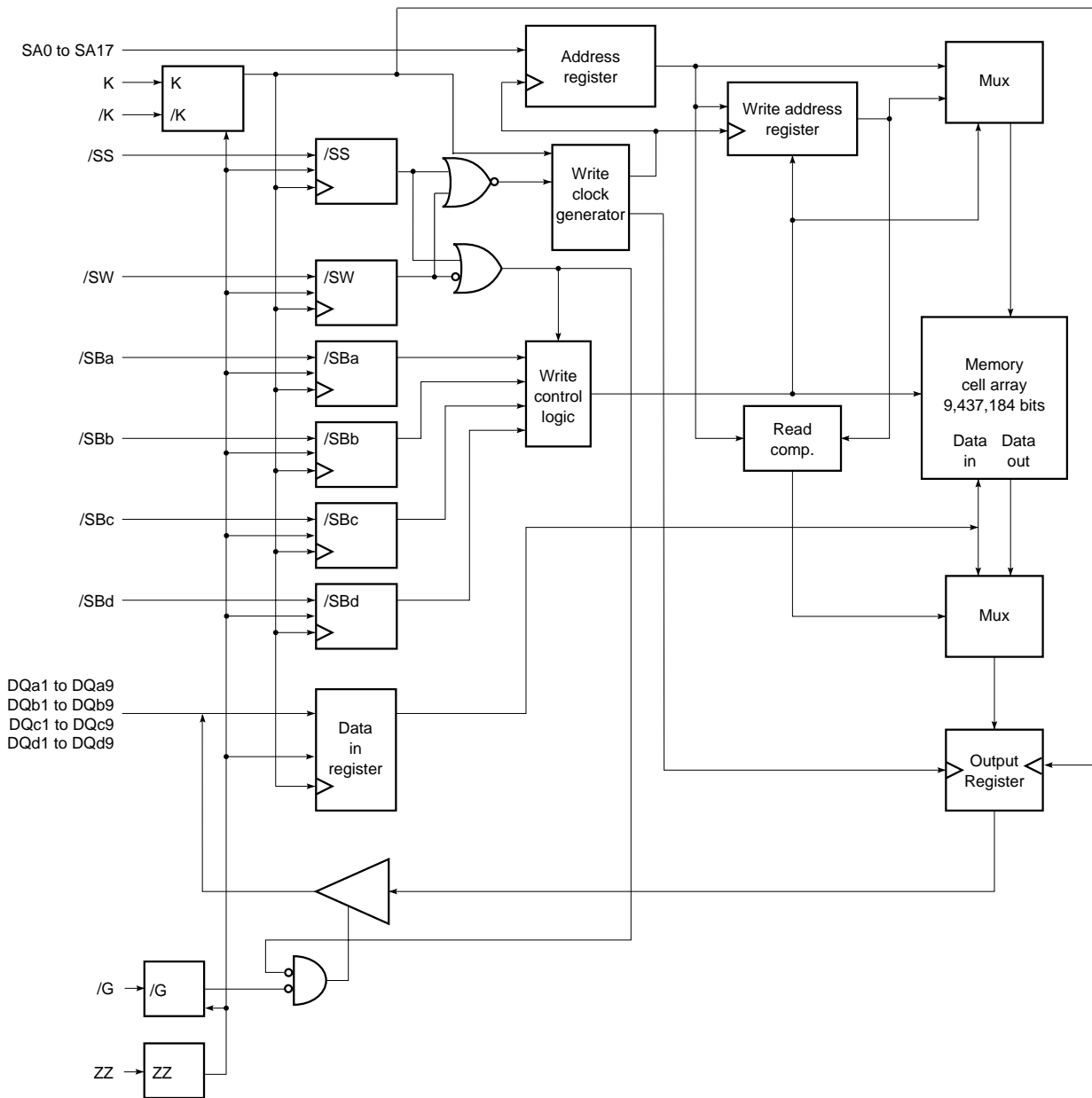

Synchronous Truth Table

ZZ	/SS	/SW	/SBa	/SBb	/SBc	/SBd	Mode	DQa1-9	DQb1-9	DQc1-9	DQd1-9	Power
L	H	×	×	×	×	×	Not selected	Hi-Z	Hi-Z	Hi-Z	Hi-Z	Active
L	L	H	×	×	×	×	Read	Dout	Dout	Dout	Dout	Active
L	L	L	L	L	L	L	Write	Din	Din	Din	Din	Active
L	L	L	L	H	H	H	Write	Din	Hi-Z	Hi-Z	Hi-Z	Active
L	L	L	H	L	L	L	Write	Hi-Z	Din	Din	Din	Active
L	L	L	H	H	H	H	Abort Write	Hi-Z	Hi-Z	Hi-Z	Hi-Z	Active
H	×	×	×	×	×	×	Sleep Mode	Hi-Z	Hi-Z	Hi-Z	Hi-Z	Standby

Remark × : Don't care

Output Enable Truth Table

Mode	/G	DQ
Read	L	Dout
Read	H	Hi-Z
Sleep (ZZ=H)	×	Hi-Z
Write (/SW=L)	×	Hi-Z, Din
Deselect (/SS=H)	×	Hi-Z

Remark × : Don't care

Electrical Specifications

Absolute Maximum Ratings

Parameter	Symbol	Condition	MIN.	TYP.	MAX.	Unit	Note
Supply voltage	V _{DD}		-0.5		+4.0	V	1
Output supply voltage	V _{DDQ}		-0.5		+4.0	V	1
Input voltage	V _{IN}		-0.5		V _{DD} + 0.3	V	1
Input / Output voltage	V _{I/O}		-0.5		V _{DDQ} + 0.3	V	1
Operating temperature	T _A		0		50	°C	
Storage temperature	T _{stg}		-55		+125	°C	

Note 1. -2.0 V MIN. (Pulse width : 2 ns)

Caution Exposing the device to stress above those listed in Absolute Maximum Rating could cause permanent damage. The device is not meant to be operated under conditions outside the limits described in the operational section of this specification. Exposure to Absolute Maximum Rating conditions for extended periods may affect device reliability.

Recommended DC Operating Conditions (T_A = 0 to 50 °C)

Parameter	Symbol	Conditions	MIN.	TYP.	MAX.	Unit
Core supply voltage	V _{DD}		3.135	3.3	3.465	V
Output buffer supply voltage	V _{DDQ}		1.4	1.5	1.6	V
Input reference voltage	V _{REF}		0.7	0.75	0.8	V
Low level input voltage	V _{IL}		-0.3 ^{Note}		V _{REF} -0.1	V
High level input voltage	V _{IH}		V _{REF} +0.1		V _{DDQ} +0.3	V

Note -0.8 V MIN. (Pulse width : 2 ns)

Recommended AC Operating Conditions (T_A = 0 to 50 °C)

Parameter	Symbol	Conditions	MIN.	TYP.	MAX.	Unit
Input reference voltage	V _{REF} (RMS)		-5%		+5%	V
Low level input voltage	V _{IL}		-0.3		V _{REF} -0.2	V
High level input voltage	V _{IH}		V _{REF} +0.2		V _{DDQ} +0.3	V

Capacitance (T_A = 25 °C, f = 1 MHz)

Parameter ^{Note}	Symbol	Test conditions	MAX.	Unit
★ Input capacitance	C _{IN}	V _{IN} = 0 V	5.5	pF
Input / Output capacitance	C _{I/O}	V _{I/O} = 0 V	7.0	pF
★ Clock Input Capacitance	C _{clk}	V _{clk} = 0 V	6.0	pF

Note These parameters are sampled and not 100% tested.

DC Characteristics (Recommended Operating Conditions Unless Otherwise Noted)

Parameter	Symbol	Conditions	MIN.	TYP.	MAX.	Unit
Input leakage current	I _{LI}	V _{IN} = 0 to V _{DD}	-5		+5	μA
DQ leakage current	I _{LO}	V _{I/O} = 0 to V _{DDQ}	-5		+5	μA
Operating supply current	I _{DD}	V _{IN} = V _{IH} or V _{IL} , /SS = V _{IL} , ZZ = V _{IL} , Cycle = MAX., I _{DQ} = 0 mA			480	mA
★ Sleep mode power supply current	I _{SBZZ}	ZZ = V _{IH} , All other inputs = V _{IH} or V _{IL} , Cycle = DC, I _{DQ} = 0 mA			20	mA

Output Voltage on Push-Pull Output Buffer Mode

Parameter	Symbol	Conditions	MIN.	TYP.	MAX.	Unit
Low level output voltage	V _{OL}	I _{OL} = + 2 mA	-		0.3	V
High level output voltage	V _{OH}	I _{OH} = - 2 mA	V _{DDQ} -0.3		-	V

AC Characteristics (Recommended Operating Conditions Unless Otherwise Noted)

AC Characteristics Test Conditions

Input waveform (rise and fall time = 0.5 ns (20 to 80%))

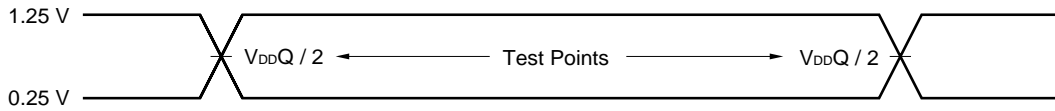

- Remarks**
1. Clock input differential voltage
 2. Clock input common mode voltage range

Output waveform

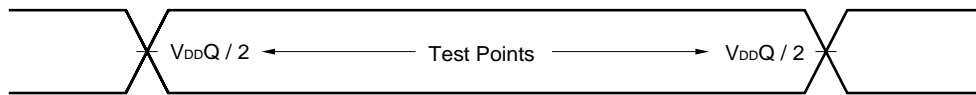

Single Differential Clock, Registered Input / Registered Output Mode

Parameter		Symbol	-A75 (133 MHz)		Unit	Notes	
			MIN.	MAX.			
Clock cycle time		t _{KHKH}	7.5	–	ns		
Clock phase time		t _{KHKL} / t _{KLKH}	2.0	–	ns		
Setup times	Address	t _{AVKH}	2.0	–	ns		
	Write data	t _{DVKH}					
	Write enable	t _{WVKH}					
	Chip select	t _{SVKH}					
Hold times	Address	t _{KHAX}	0.5	–	ns		
	Write data	t _{KHDX}					
	Write enable	t _{KHWX}					
	Chip select	t _{KHSX}					
★	Clock access time		t _{KHQV}	–	3.8	ns	1
	K high to Q change		t _{KHQX}	1.5	–	ns	2
★	/G low to Q valid		t _{GLQV}	–	3.8	ns	1
	/G low to Q change		t _{GLQX}	0	–	ns	2
★	/G high to Q Hi-Z		t _{GHQZ}	0	3.8	ns	2
★	K high to Q Hi-Z (/SW)		t _{KHQZ}	1.5	3.8	ns	2
★	K high to Q Hi-Z (/SS)		t _{KHQZ2}	1.5	3.8	ns	2
	K high to Q Lo-Z		t _{KHQX2}	1.5	–	ns	2
Sleep Mode Recovery		t _{ZZR}	–	7.5	ns		
Sleep Mode Enable		t _{ZZE}	–	7.5	ns		

Notes 1. See figure. (V_{TT}=0.75 V)

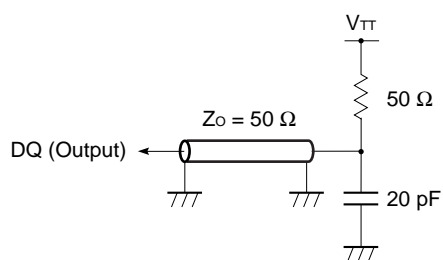

2. See figure. (V_{TT}=0.75 V)

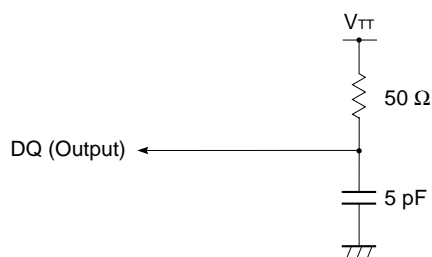

Read Operation

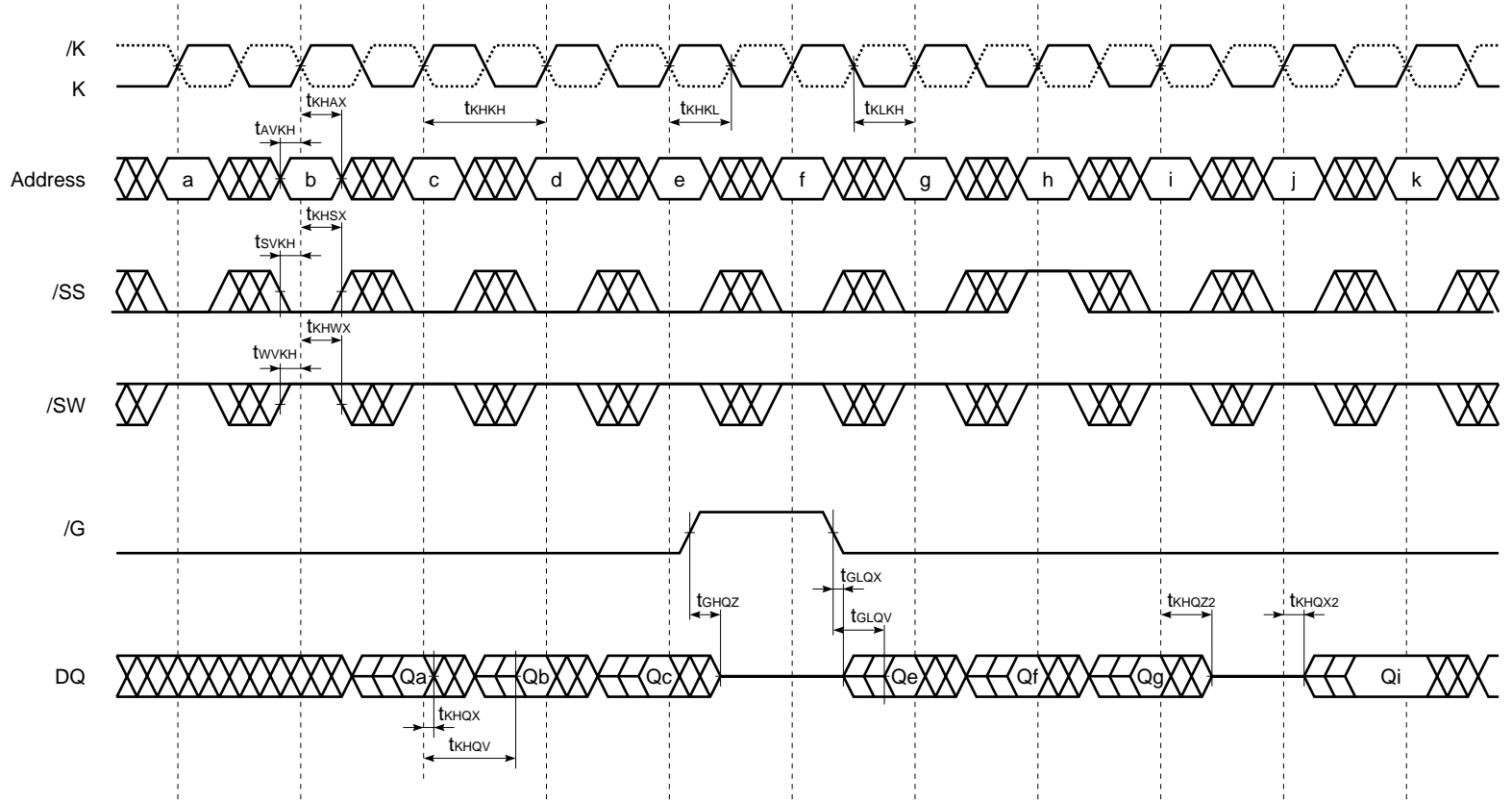

Write Operation

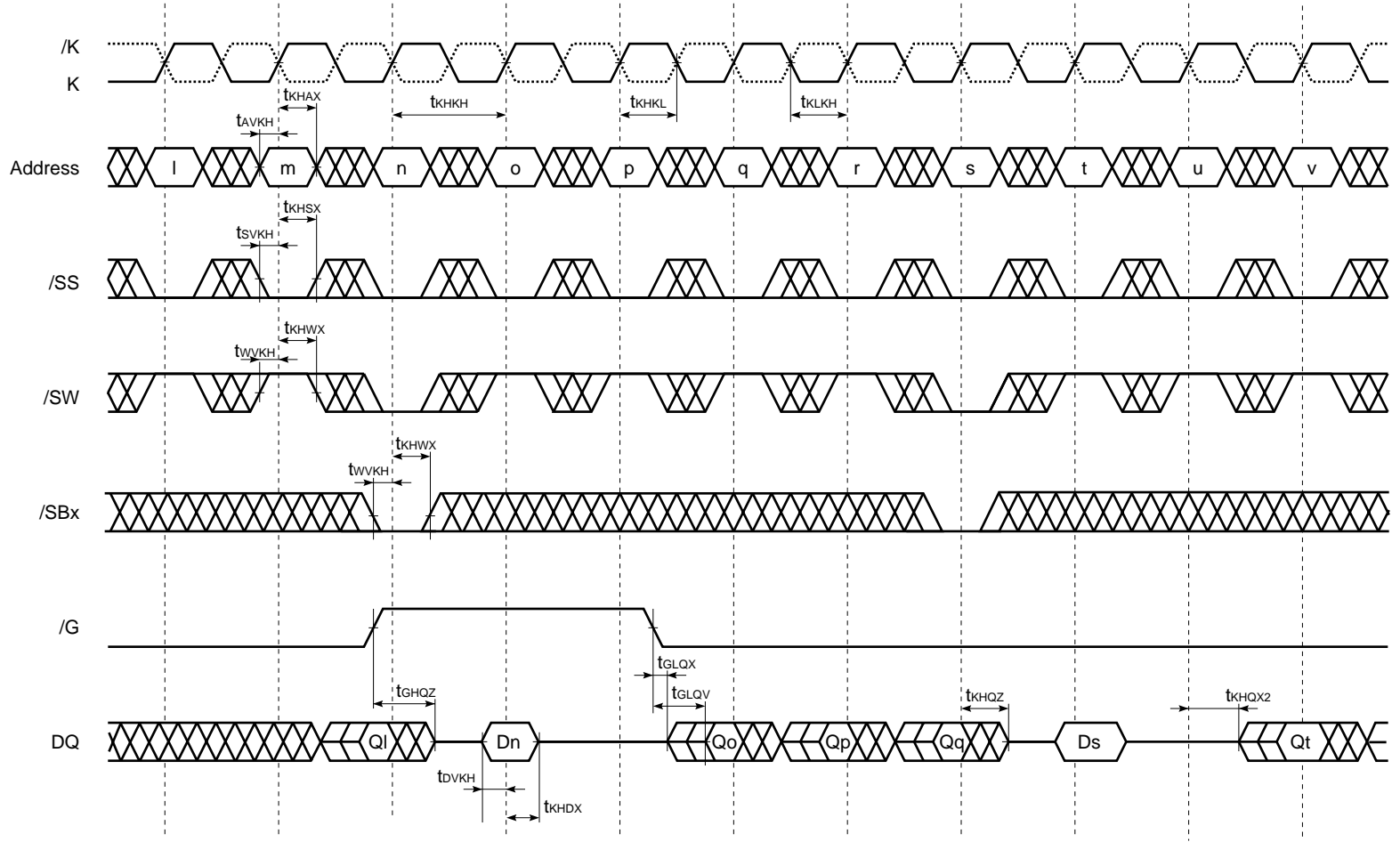

Sleep Mode

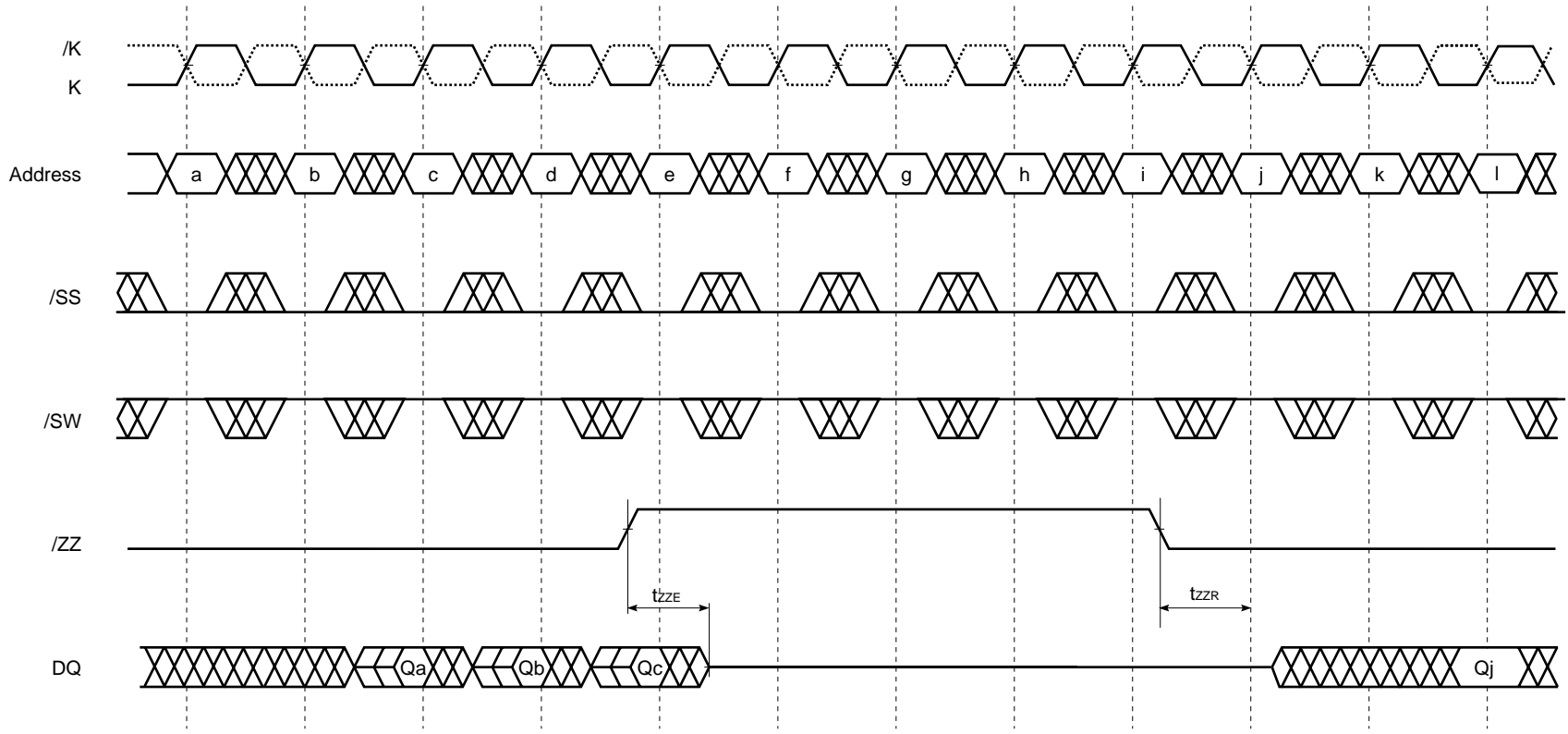

Package Drawing

100-PIN PLASTIC LQFP (14x20)

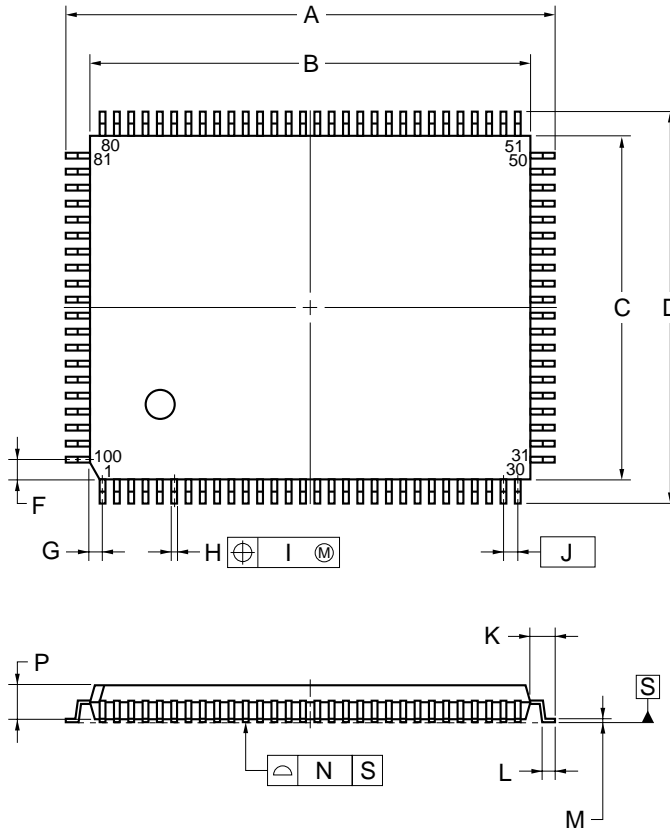

detail of lead end

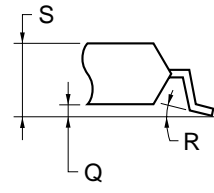

NOTE

Each lead centerline is located within 0.13 mm of its true position (T.P.) at maximum material condition.

ITEM	MILLIMETERS
A	22.0±0.2
B	20.0±0.2
C	14.0±0.2
D	16.0±0.2
F	0.825
G	0.575
H	0.32 ^{+0.08} _{-0.07}
I	0.13
J	0.65 (T.P.)
K	1.0±0.2
L	0.5±0.2
M	0.17 ^{+0.06} _{-0.05}
N	0.10
P	1.4
Q	0.125±0.075
R	3° ^{+7°} _{-3°}
S	1.7 MAX.

S100GF-65-8ET-1

Recommended Soldering Conditions

Please consult with our sales offices for soldering conditions of the μ PD4383362.

Type of Surface Mount Device

μ PD4383362GF: 100-PIN PLASTIC LQFP (14 x 20)

NOTES FOR CMOS DEVICES**① PRECAUTION AGAINST ESD FOR SEMICONDUCTORS**

Note:

Strong electric field, when exposed to a MOS device, can cause destruction of the gate oxide and ultimately degrade the device operation. Steps must be taken to stop generation of static electricity as much as possible, and quickly dissipate it once, when it has occurred. Environmental control must be adequate. When it is dry, humidifier should be used. It is recommended to avoid using insulators that easily build static electricity. Semiconductor devices must be stored and transported in an anti-static container, static shielding bag or conductive material. All test and measurement tools including work bench and floor should be grounded. The operator should be grounded using wrist strap. Semiconductor devices must not be touched with bare hands. Similar precautions need to be taken for PW boards with semiconductor devices on it.

② HANDLING OF UNUSED INPUT PINS FOR CMOS

Note:

No connection for CMOS device inputs can be cause of malfunction. If no connection is provided to the input pins, it is possible that an internal input level may be generated due to noise, etc., hence causing malfunction. CMOS devices behave differently than Bipolar or NMOS devices. Input levels of CMOS devices must be fixed high or low by using a pull-up or pull-down circuitry. Each unused pin should be connected to V_{DD} or GND with a resistor, if it is considered to have a possibility of being an output pin. All handling related to the unused pins must be judged device by device and related specifications governing the devices.

③ STATUS BEFORE INITIALIZATION OF MOS DEVICES

Note:

Power-on does not necessarily define initial status of MOS device. Production process of MOS does not define the initial operation status of the device. Immediately after the power source is turned ON, the devices with reset function have not yet been initialized. Hence, power-on does not guarantee out-pin levels, I/O settings or contents of registers. Device is not initialized until the reset signal is received. Reset operation must be executed immediately after power-on for devices having reset function.

[MEMO]

- **The information in this document is current as of July, 2000. The information is subject to change without notice. For actual design-in, refer to the latest publications of NEC's data sheets or data books, etc., for the most up-to-date specifications of NEC semiconductor products. Not all products and/or types are available in every country. Please check with an NEC sales representative for availability and additional information.**
 - No part of this document may be copied or reproduced in any form or by any means without prior written consent of NEC. NEC assumes no responsibility for any errors that may appear in this document.
 - NEC does not assume any liability for infringement of patents, copyrights or other intellectual property rights of third parties by or arising from the use of NEC semiconductor products listed in this document or any other liability arising from the use of such products. No license, express, implied or otherwise, is granted under any patents, copyrights or other intellectual property rights of NEC or others.
 - Descriptions of circuits, software and other related information in this document are provided for illustrative purposes in semiconductor product operation and application examples. The incorporation of these circuits, software and information in the design of customer's equipment shall be done under the full responsibility of customer. NEC assumes no responsibility for any losses incurred by customers or third parties arising from the use of these circuits, software and information.
 - While NEC endeavours to enhance the quality, reliability and safety of NEC semiconductor products, customers agree and acknowledge that the possibility of defects thereof cannot be eliminated entirely. To minimize risks of damage to property or injury (including death) to persons arising from defects in NEC semiconductor products, customers must incorporate sufficient safety measures in their design, such as redundancy, fire-containment, and anti-failure features.
 - NEC semiconductor products are classified into the following three quality grades:
"Standard", "Special" and "Specific". The "Specific" quality grade applies only to semiconductor products developed based on a customer-designated "quality assurance program" for a specific application. The recommended applications of a semiconductor product depend on its quality grade, as indicated below. Customers must check the quality grade of each semiconductor product before using it in a particular application.
"Standard": Computers, office equipment, communications equipment, test and measurement equipment, audio and visual equipment, home electronic appliances, machine tools, personal electronic equipment and industrial robots
"Special": Transportation equipment (automobiles, trains, ships, etc.), traffic control systems, anti-disaster systems, anti-crime systems, safety equipment and medical equipment (not specifically designed for life support)
"Specific": Aircraft, aerospace equipment, submersible repeaters, nuclear reactor control systems, life support systems and medical equipment for life support, etc.
- The quality grade of NEC semiconductor products is "Standard" unless otherwise expressly specified in NEC's data sheets or data books, etc. If customers wish to use NEC semiconductor products in applications not intended by NEC, they must contact an NEC sales representative in advance to determine NEC's willingness to support a given application.
- (Note)
- (1) "NEC" as used in this statement means NEC Corporation and also includes its majority-owned subsidiaries.
 - (2) "NEC semiconductor products" means any semiconductor product developed or manufactured by or for NEC (as defined above).

M8E 00.4