

TOSHIBA LED LAMP

**TLG241P, TLO241P, TLPG241P  
TLRC241P, TLS241P, TLY241P**

Unit in mm

- Flange Less Package
- Light Colored Transparent Lens
- Oval Lens, Ideal for Light Output
- Fast Response Time, Capable of Pulse Operation
- Six Colored Line Up
- Without Stand-offs

MATERIALS

PRODUCT NAME	MATERIALS	LIGHT EMITTING COLOR
TLPG241P	GaP	Pure Green
TLG241P	GaP	Green
TLY241P	GaAsP	Yellow
TLO241P	GaAsP	Orange
TLS241P	GaAsP	Red
TLRC241P	GaAlAs	

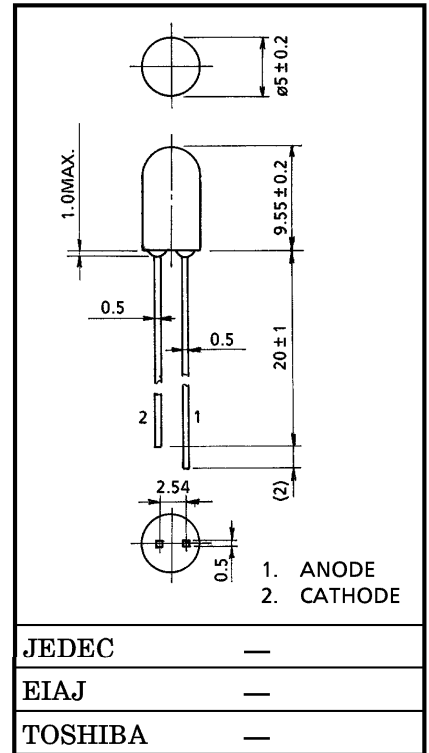

Weight : 0.31g

MAXIMUM RATINGS (Ta = 25°C)

PRODUCT NAME	FORWARD CURRENT I <sub>F</sub> (mA)	REVERSE VOLTAGE V <sub>R</sub> (V)	POWER DISSIPATION P <sub>D</sub> (mW)	OPERATING TEMPERATURE RANGE T <sub>opr</sub> (°C)	STORAGE TEMPERATURE RANGE T <sub>stg</sub> (°C)
TLPG241P	25	4	70	-20~75	-30~100
TLG241P	25	4	70	-20~75	-30~100
TLY241P	25	4	70	-20~75	-30~100
TLO241P	25	4	70	-20~75	-30~100
TLS241P	25	4	70	-20~75	-30~100
TLRC241P	25	4	55	-20~75	-30~100

PRODUCT NAME	EMISSION SPECTRUM			LUMINOUS INTENSITY $I_V$			FORWARD VOLTAGE $V_F$			REVERSE CURRENT $I_R$	
	$\lambda_p$	$\Delta\lambda$	$I_F$	MIN.	TYP.	$I_F$	TYP.	MAX.	$I_F$	MAX.	$V_R$
TLPG241P	555	20	20	27	100	20	2.15	2.8	20	100	4
TLG241P	565	25	20	48	200	20	2.15	2.8	20	100	4
TLY241P	585	32	20	48	150	20	2.05	2.8	20	100	4
TLO241P	610	35	20	48	150	20	2.05	2.8	20	100	4
TLS241P	635	40	20	48	150	20	2.05	2.8	20	100	4
TLRC241P	660	25	20	85	600	20	1.75	2.2	20	100	4
Unit	nm		mA	mcd		mA	V		mA	$\mu\text{A}$	V

**PRECAUTION**

Please be careful of the followings.

- Soldering temperature : 260°C MAX. Soldering time : 3s MAX.  
(Soldering portion of lead : up to 2mm from the body of the device)
- If the lead is formed, the lead should be formed up to 5mm from the body of the device without forming stress to the resin. Soldering should be performed after lead forming.
- The TLRC series should not be used in high-temperature, high-humidity environments.

$I_V - I_F$

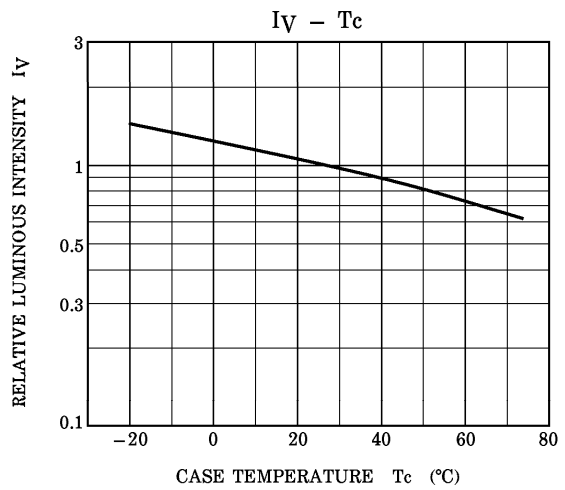
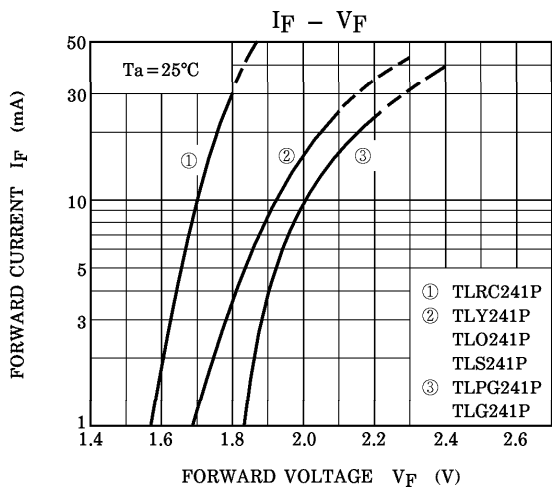
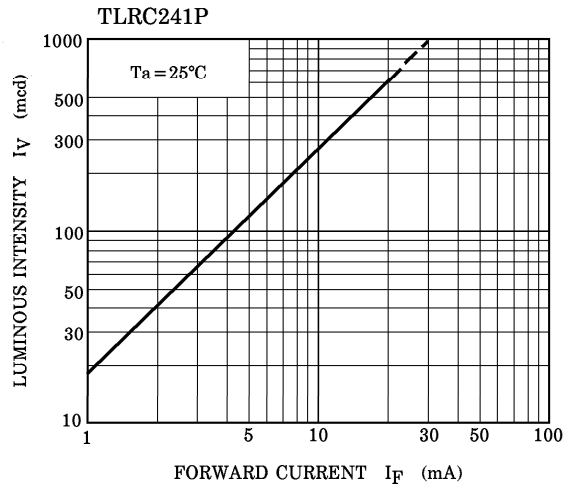
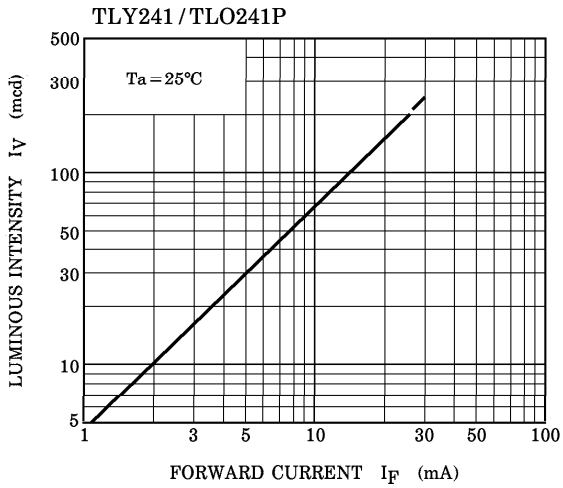
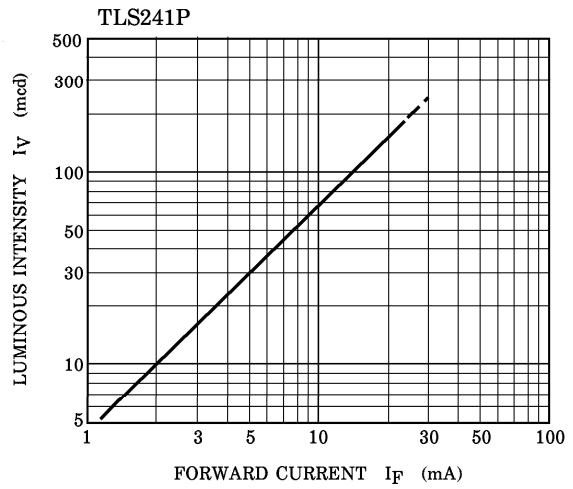
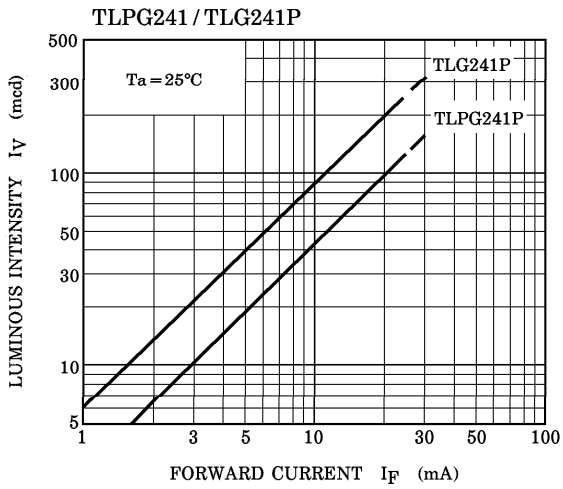

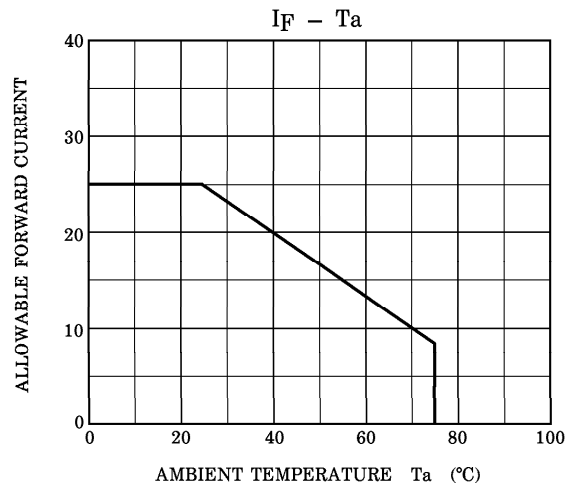
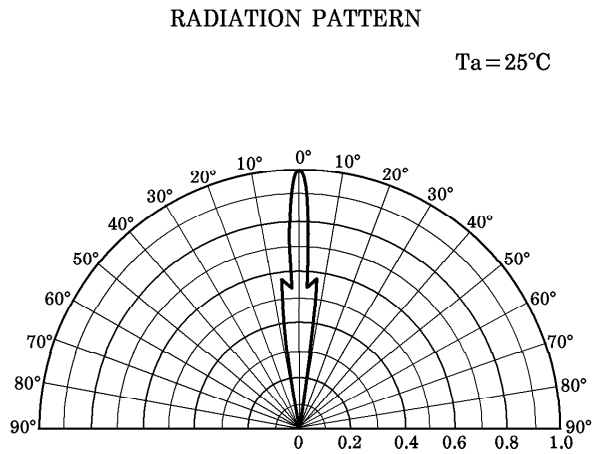
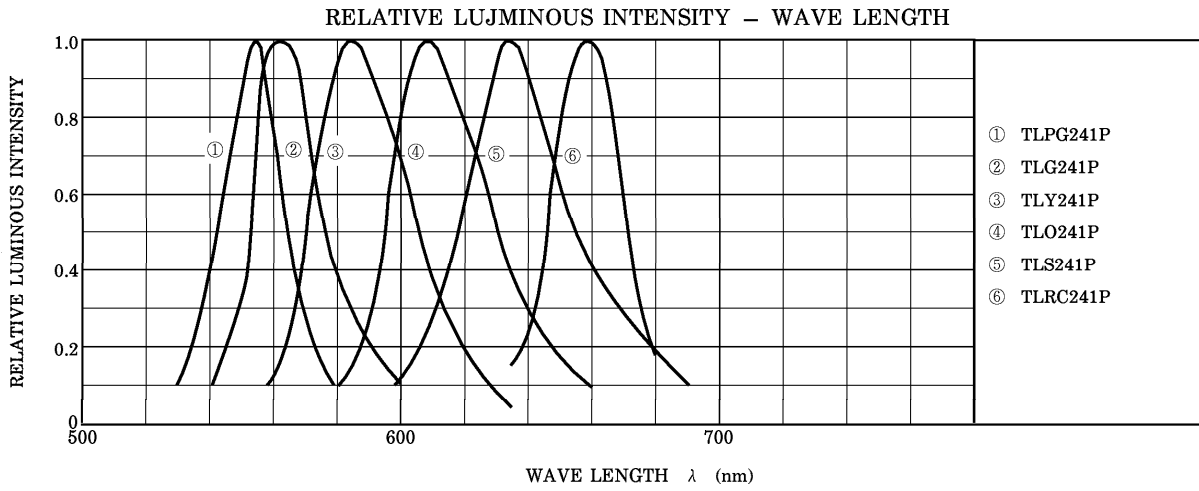

**RESTRICTIONS ON PRODUCT USE**

000707EAC

- TOSHIBA is continually working to improve the quality and reliability of its products. Nevertheless, semiconductor devices in general can malfunction or fail due to their inherent electrical sensitivity and vulnerability to physical stress. It is the responsibility of the buyer, when utilizing TOSHIBA products, to comply with the standards of safety in making a safe design for the entire system, and to avoid situations in which a malfunction or failure of such TOSHIBA products could cause loss of human life, bodily injury or damage to property. In developing your designs, please ensure that TOSHIBA products are used within specified operating ranges as set forth in the most recent TOSHIBA products specifications. Also, please keep in mind the precautions and conditions set forth in the "Handling Guide for Semiconductor Devices," or "TOSHIBA Semiconductor Reliability Handbook" etc..
- The TOSHIBA products listed in this document are intended for usage in general electronics applications (computer, personal equipment, office equipment, measuring equipment, industrial robotics, domestic appliances, etc.). These TOSHIBA products are neither intended nor warranted for usage in equipment that requires extraordinarily high quality and/or reliability or a malfunction or failure of which may cause loss of human life or bodily injury ("Unintended Usage"). Unintended Usage include atomic energy control instruments, airplane or spaceship instruments, transportation instruments, traffic signal instruments, combustion control instruments, medical instruments, all types of safety devices, etc.. Unintended Usage of TOSHIBA products listed in this document shall be made at the customer's own risk.
- Gallium arsenide (GaAs) is a substance used in the products described in this document. GaAs dust and fumes are toxic. Do not break, cut or pulverize the product, or use chemicals to dissolve them. When disposing of the products, follow the appropriate regulations. Do not dispose of the products with other industrial waste or with domestic garbage.
- The information contained herein is presented only as a guide for the applications of our products. No responsibility is assumed by TOSHIBA CORPORATION for any infringements of intellectual property or other rights of the third parties which may result from its use. No license is granted by implication or otherwise under any intellectual property or other rights of TOSHIBA CORPORATION or others.
- The information contained herein is subject to change without notice.