

# Ultrafast Recovery Modules

## UFT70SM, 71SM & 72SM

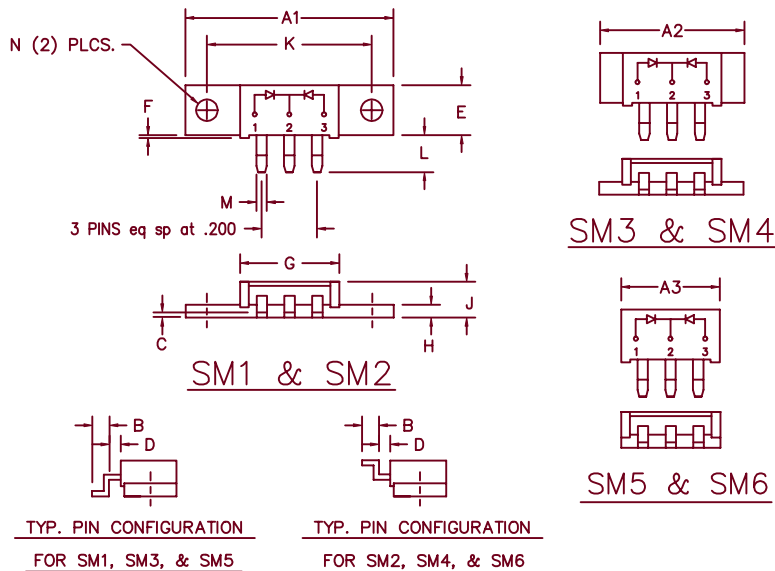

Dim.	Inches		Millimeter		Notes
	Minimum	Maximum	Minimum	Maximum	
A1	1.490	1.510	37.85	38.35	
A2	1.020	1.040	26.12	26.42	
A3	.695	.715	17.65	18.16	
B	.110	.120	2.79	3.04	
C	.027	.037	0.69	0.94	
D	.100	.110	2.54	2.79	
E	.350	.370	8.89	9.40	
F	.015	.025	0.38	0.64	
G	.695	.715	17.65	18.16	
H	.088	.098	2.24	2.49	
J	.240	.260	6.10	6.60	
K	1.180	1.195	29.97	30.35	
L	.230	.250	5.84	6.35	
M	.065	.085	1.65	2.16	
N	.151	.161	3.84	4.09	Dia.

Microsemi Catalog Number	Working Peak Reverse Voltage	Repetitive Peak Reverse Voltage
UFT7010SM ①②	100V	100V
UFT7015SM --	150V	150V
UFT7020SM -- UFT7120SM ①②	200V	200V
UFT7130SM --	300V	300V
UFT7140SM --	400V	400V
UFT7250SM ①② UFT7150SM --	500V	500V
UFT7260SM --	600V	600V
UFT7270SM --	700V	700V
UFT7280SM --	800V	800V

Note: ① Specify (1-6) to identify package desired  
 ② Specify C-Common Cathode, A-Common Anode, D-Doubler

- Ultra Fast Recovery
- 175°C Junction Temperature
- $V_{RRM}$  100 to 800 Volts
- Unique surface mount package
- 2 X 35 Amp current rating

Electrical Characteristics			
	UFT70SM	UFT71SM	UFT72SM
Average forward current per pkg	$I_{F(AV)}$ 70A	70A	70A
Average forward current per leg	$I_{F(AV)}$ 35A	35A	35A
Case Temperature	$T_C$ 148°C	142°C	138°C
Maximum surge current per leg	$I_{FSM}$ 700A	600A	500A
Max peak forward voltage per leg	$V_{FM}$ .95V	1.20V	1.35V
Max reverse recovery time per leg	$t_{rr}$ 50ns	60ns	75ns
Max peak reverse current per leg	$I_{RM}$ ---	3.0mA	---
Max peak reverse current per leg	$I_{RM}$ ---	25μA	---
Typical Junction capacitance	$C_J$ 300pF	120pF	115pF

\*Pulse test: Pulse width 300 usec, Duty cycle 2%

Thermal and Mechanical Characteristics		
Storage temp range	$T_{STG}$	-55°C to 175°C
Operating junction temp range	$T_J$	-55°C to 175°C
Max thermal resistance per leg	$R_{\theta JC}$	1.0°C/W Junction to case
Max thermal resistance per pkg	$R_{\theta JC}$	0.5°C/W Junction to case
Typical thermal resistance (greased)	$R_{\theta CS}$	0.3°C/W Case to sink
Mounting Base Torque		10 inch pounds maximum
Weight	SM1-2	0.3 ounce (8.4 grams) typical
	SM3-4	0.24 ounce (6.7 grams) typical
	SM5-6	0.18 ounce (5.2 grams) typical

# UFT70SM1 — SM6

Figure 1  
Typical Forward Characteristics — Per Leg

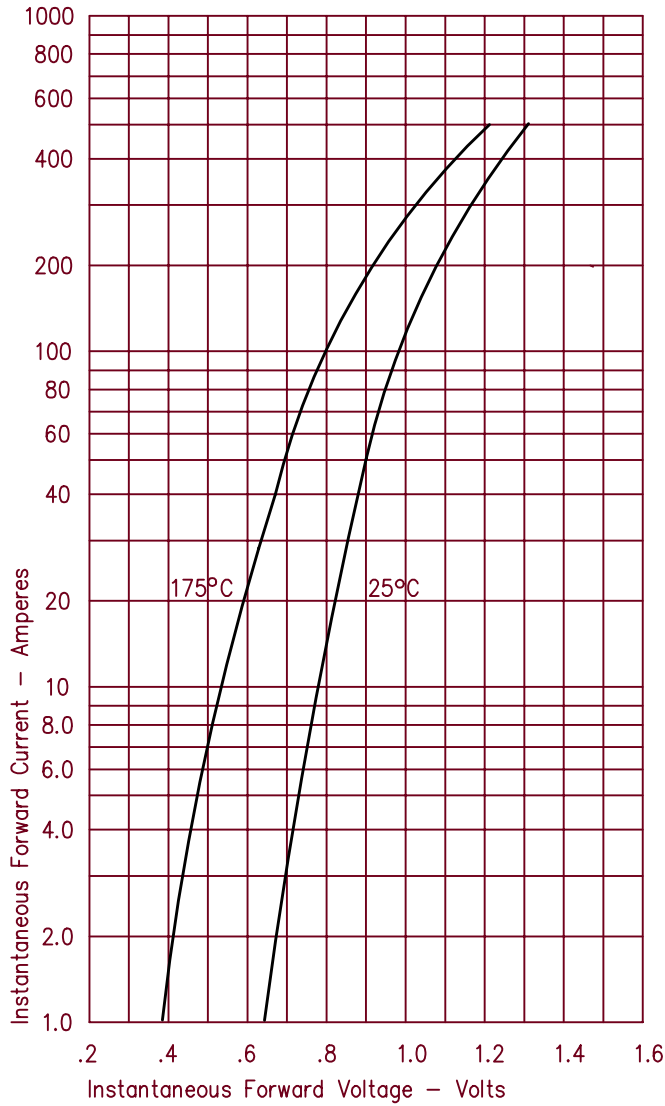

Figure 3  
Typical Junction Capacitance — Per Leg

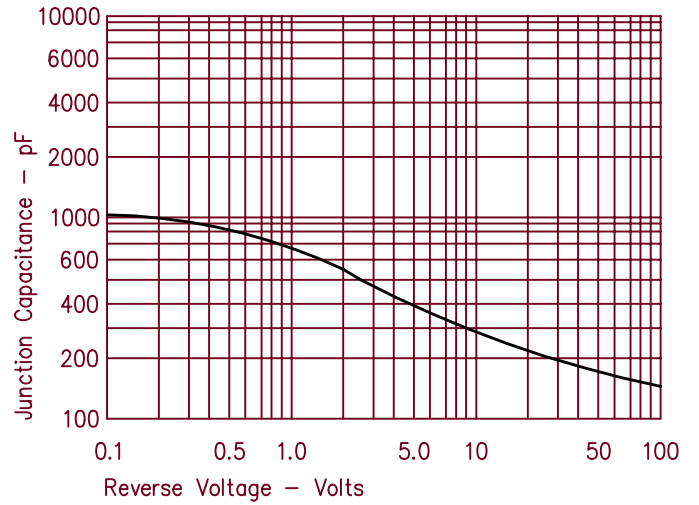

Figure 4  
Forward Current Derating — Per Leg

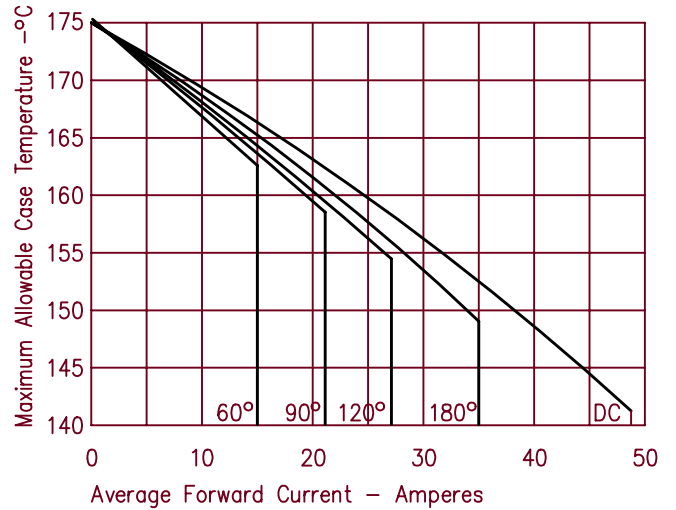

Figure 2  
Typical Reverse Characteristics — Per Leg

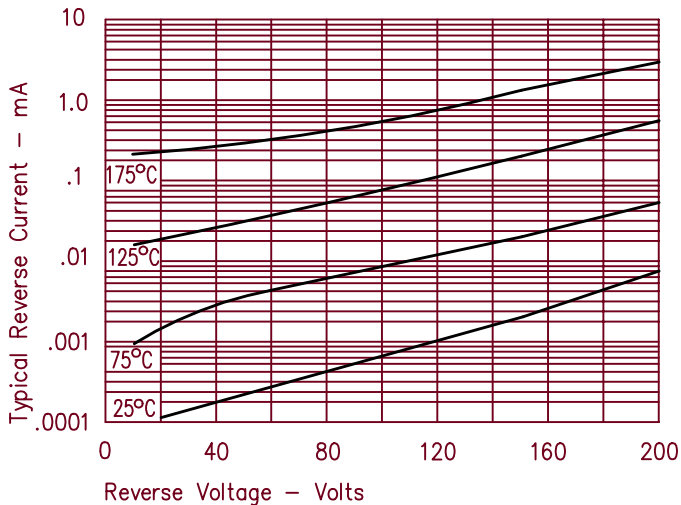
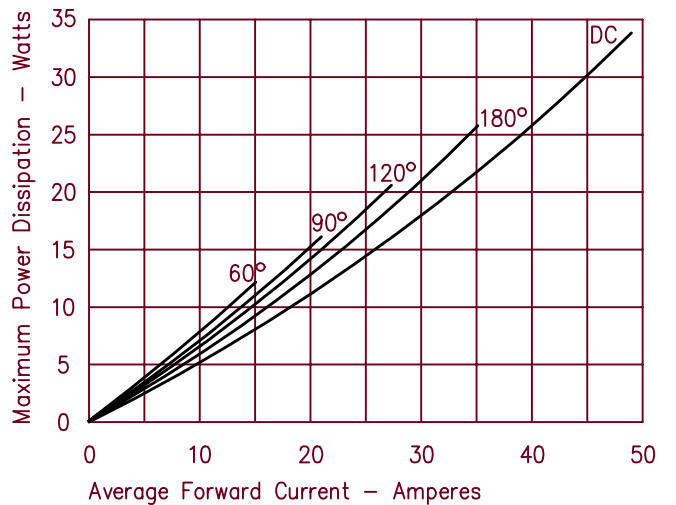

Figure 5  
Maximum Forward Power Dissipation — Per Leg



# UFT71SM1 – SM6

Figure 1  
Typical Forward Characteristics – Per Leg



Figure 3  
Typical Junction Capacitance – Per Leg

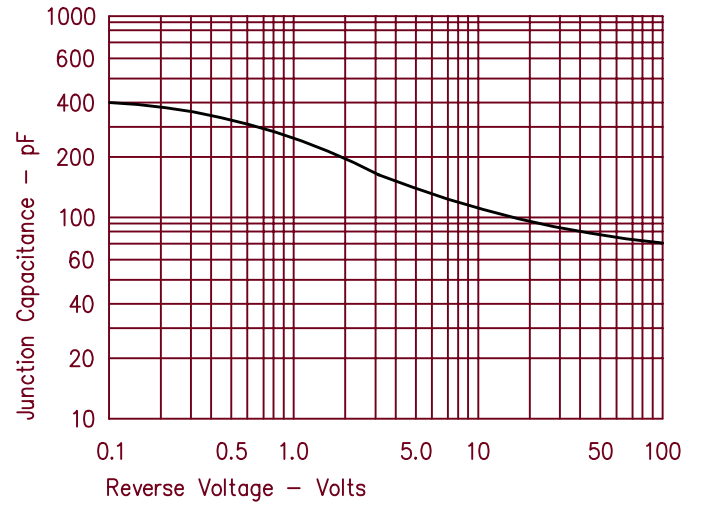

Figure 4  
Forward Current Derating – Per Leg

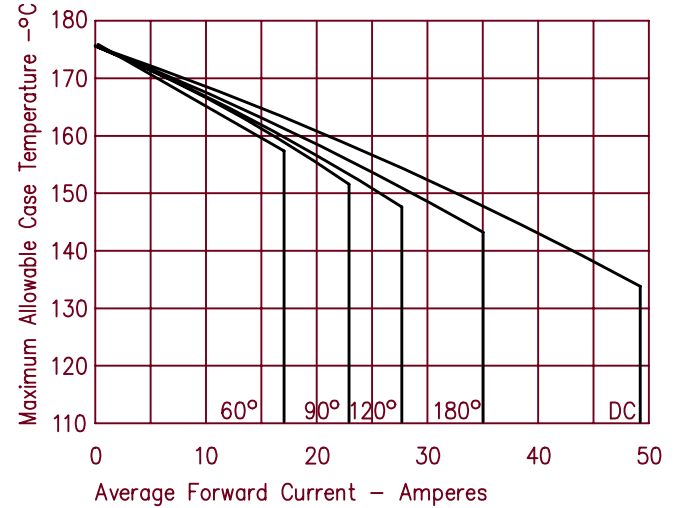

Figure 2  
Typical Reverse Characteristics – Per Leg

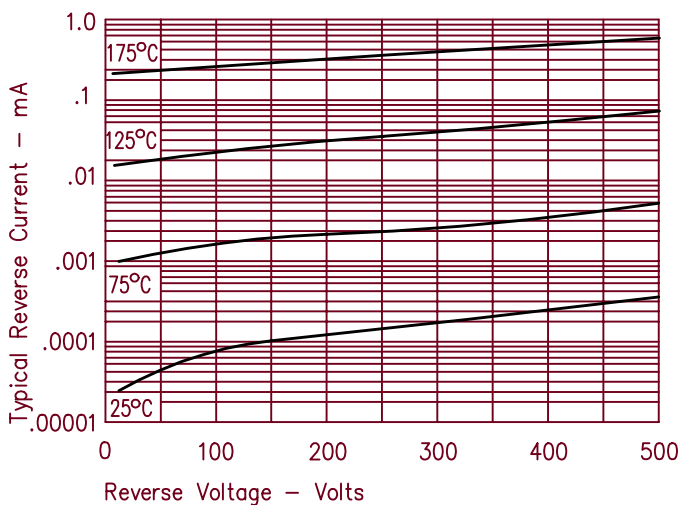
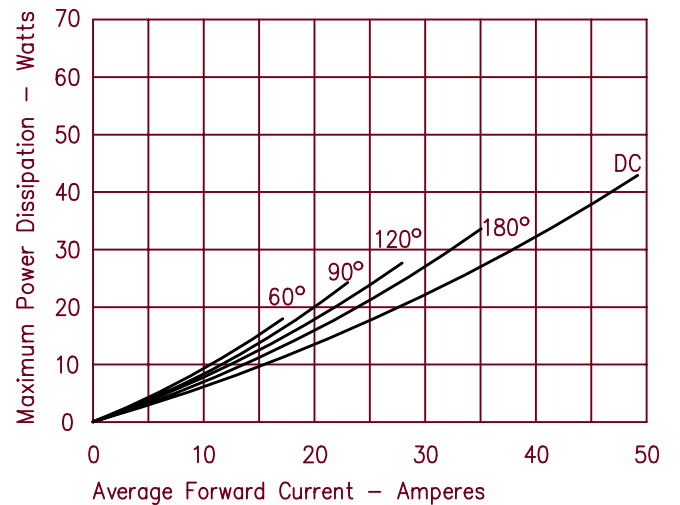

Figure 5  
Maximum Forward Power Dissipation – Per Leg



# UFT72SM1 — SM6

Figure 1  
Typical Forward Characteristics — Per Leg

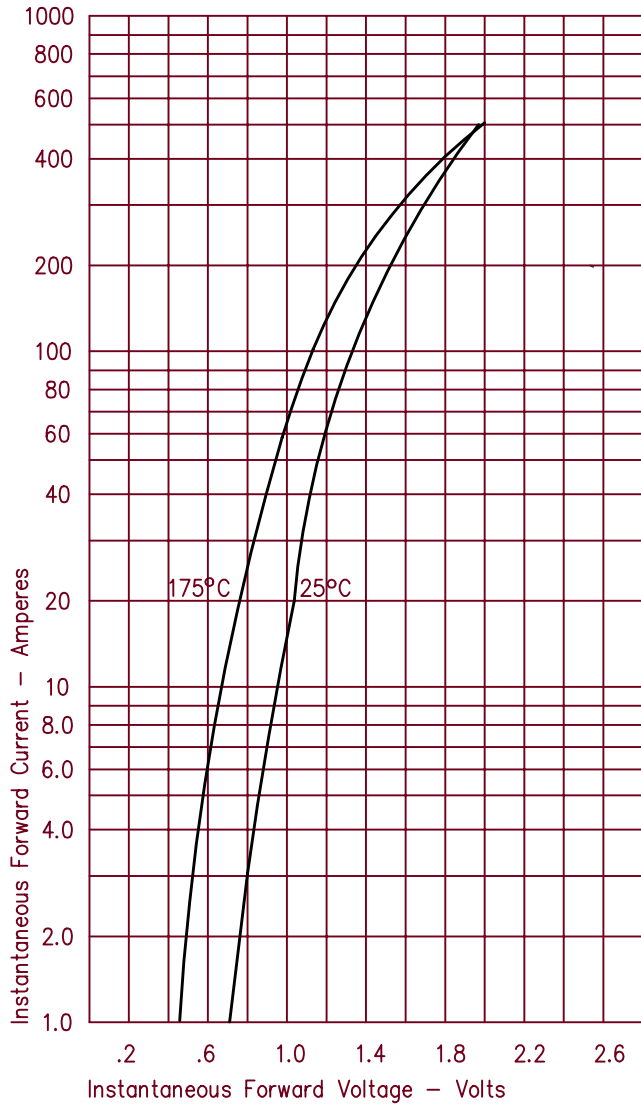

Figure 3  
Typical Junction Capacitance — Per Leg

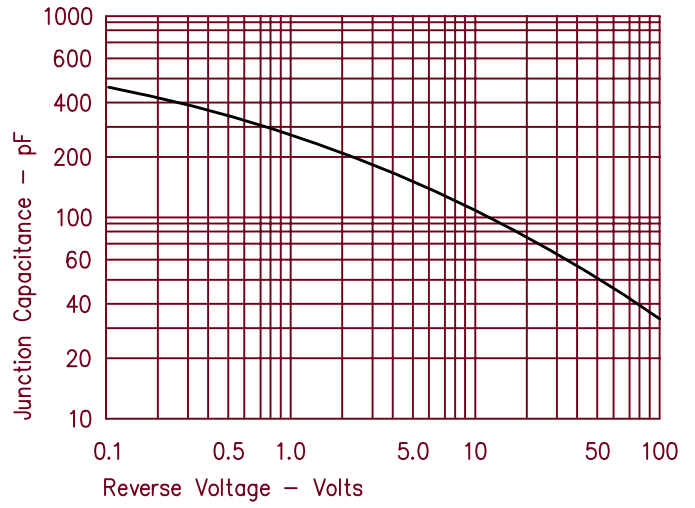

Figure 4  
Forward Current Derating — Per Leg

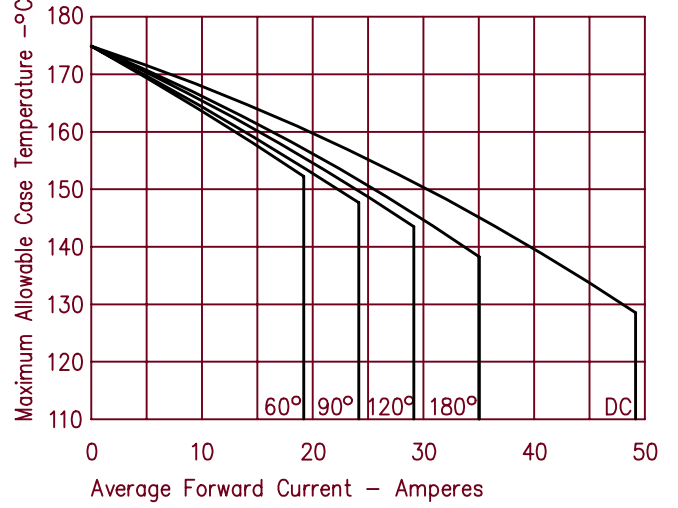

Figure 2  
Typical Reverse Characteristics — Per Leg

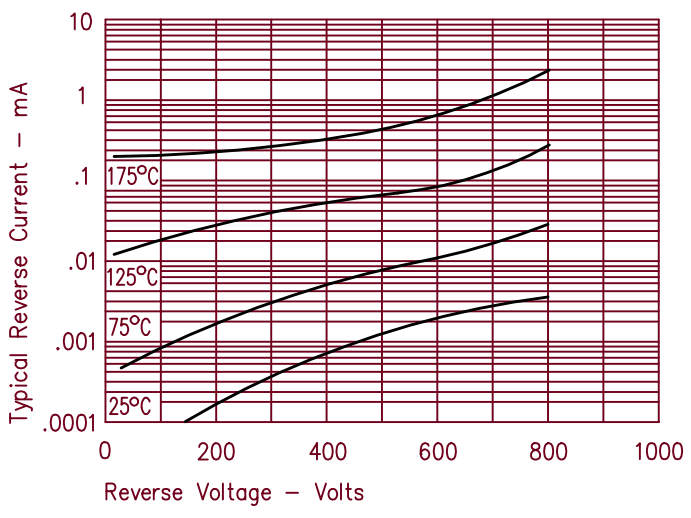

Figure 5  
Maximum Forward Power Dissipation — Per Leg

