

High Efficiency LED, ø 5 mm Tinted Non-Diffused Package

Color	Type	Technology	Angle of Half Intensity $\pm\varphi$
High efficiency red	TLHR52../TLHR62..	GaAsP on GaP	14°
Yellow	TLHY52../TLHY62..	GaAsP on GaP	14°
Green	TLHG52../TLHG62..	GaP on GaP	14°

Description

The TLH.52.. and 62.. series was developed for standard applications like general indicating and lighting purposes.

It is housed in a 5 mm tinted non-diffused plastic package. The small viewing angle of these devices provides a high brightness.

Several selection types with different luminous intensities are offered. All LEDs are categorized in luminous intensity groups. The green and yellow LEDs are categorized additionally in wavelength groups.

That allows users to assemble LEDs with uniform appearance.

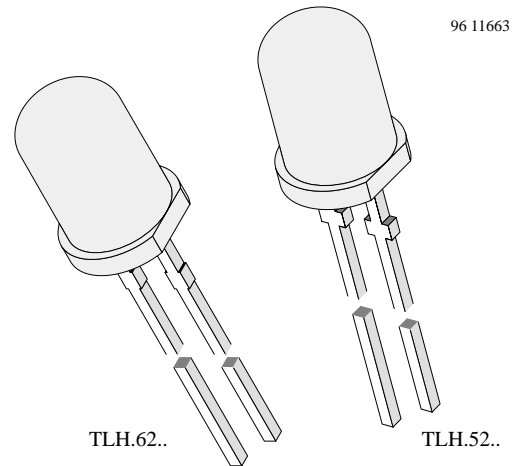

Features

- Choice of three bright colors
- Standard T-1¾ package
- Small mechanical tolerances
- Suitable for DC and high peak current
- Small viewing angle
- Luminous intensity categorized
- Yellow and green color categorized
- TLH.52.. with stand-offs
- TLH.62.. without stand-offs

Applications

Status lights
OFF / ON indicator
Background illumination
Readout lights
Maintenance lights
Legend light

Absolute Maximum Ratings

$T_{amb} = 25^{\circ}\text{C}$, unless otherwise specified

TLHR52../TLHR62.. , TLHY52../TLHY62.. , TLHG52../TLHG62.. ,

Parameter	Test Conditions	Symbol	Value	Unit
Reverse voltage		V_R	6	V
DC forward current	$T_{amb} \leq 65^{\circ}\text{C}$	I_F	30	mA
Surge forward current	$t_p \leq 10 \mu\text{s}$	I_{FSM}	1	A
Power dissipation	$T_{amb} \leq 65^{\circ}\text{C}$	P_V	100	mW
Junction temperature		T_j	100	$^{\circ}\text{C}$
Operating temperature range		T_{amb}	-20 to +100	$^{\circ}\text{C}$
Storage temperature range		T_{stg}	-55 to +100	$^{\circ}\text{C}$
Soldering temperature	$t \leq 5 \text{ s}$, 2 mm from body	T_{sd}	260	$^{\circ}\text{C}$
Thermal resistance junction/ambient		R_{thJA}	350	K/W

Optical and Electrical Characteristics

$T_{amb} = 25^{\circ}\text{C}$, unless otherwise specified

High efficiency red (TLHR52../TLHR62..)

Parameter	Test Conditions	Type	Symbol	Min	Typ	Max	Unit
Luminous intensity ¹⁾	$I_F = 10 \text{ mA}$	TLHR5200/6200	I_V	10	20		mcd
		TLHR5201/6201	I_V	16	30		mcd
		TLHR5205/6205	I_V	25	40		mcd
Dominant wavelength	$I_F = 10 \text{ mA}$		λ_d	612		625	nm
Peak wavelength	$I_F = 10 \text{ mA}$		λ_p		635		nm
Angle of half intensity	$I_F = 10 \text{ mA}$		ϕ		± 14		deg
Forward voltage	$I_F = 20 \text{ mA}$		V_F		2	3	V
Reverse voltage	$I_R = 10 \mu\text{A}$		V_R	6	15		V
Junction capacitance	$V_R = 0$, $f = 1 \text{ MHz}$		C_j		50		pF

¹⁾ in one Packing Unit $I_{V\text{Min.}}/I_{V\text{Max.}} \leq 0.5$

Yellow (TLHY52../TLHY62..)

Parameter	Test Conditions	Type	Symbol	Min	Typ	Max	Unit
Luminous intensity ¹⁾	$I_F = 10 \text{ mA}$	TLHY5200/6200	I_V	10	30		mcd
		TLHY5201/6201	I_V	16	40		mcd
		TLHY5205/6205	I_V	25	50		mcd
Dominant wavelength	$I_F = 10 \text{ mA}$		λ_d	581		594	nm
Peak wavelength	$I_F = 10 \text{ mA}$		λ_p		585		nm
Angle of half intensity	$I_F = 10 \text{ mA}$		ϕ		± 14		deg
Forward voltage	$I_F = 20 \text{ mA}$		V_F		2.4	3	V
Reverse voltage	$I_R = 10 \mu\text{A}$		V_R	6	15		V
Junction capacitance	$V_R = 0$, $f = 1 \text{ MHz}$		C_j		50		pF

¹⁾ in one Packing Unit $I_{V\text{Min.}}/I_{V\text{Max.}} \leq 0.5$

Green (TLHG52../TLHG62..)

Parameter	Test Conditions	Type	Symbol	Min	Typ	Max	Unit
Luminous intensity ¹⁾	$I_F = 10 \text{ mA}$	TLHG5200/6200	I_V	16	30		mcd
		TLHG5201/6201	I_V	25	40		mcd
		TLHG5205/6205	I_V	40	50		mcd
Dominant wavelength	$I_F = 10 \text{ mA}$		λ_d	562		575	nm
Peak wavelength	$I_F = 10 \text{ mA}$		λ_p		565		nm
Angle of half intensity	$I_F = 10 \text{ mA}$		ϕ		± 14		deg
Forward voltage	$I_F = 20 \text{ mA}$		V_F		2.4	3	V
Reverse voltage	$I_R = 10 \mu\text{A}$		V_R	6	15		V
Junction capacitance	$V_R = 0, f = 1 \text{ MHz}$		C_j		50		pF

¹⁾ in one Packing Unit $I_{V\text{Min.}}/I_{V\text{Max.}} \leq 0.5$

Typical Characteristics ($T_{\text{amb}} = 25^\circ\text{C}$, unless otherwise specified)

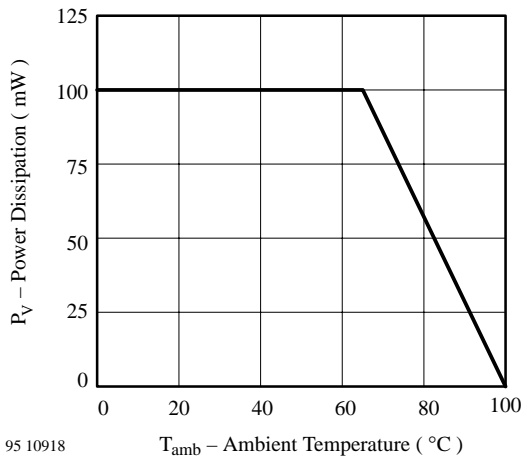

Figure 1. Power Dissipation vs. Ambient Temperature

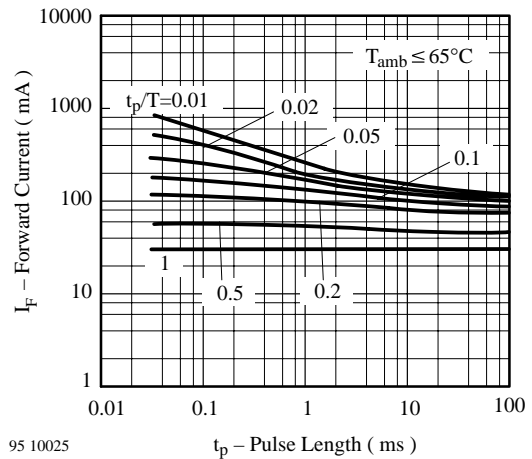

Figure 3. Forward Current vs. Pulse Length

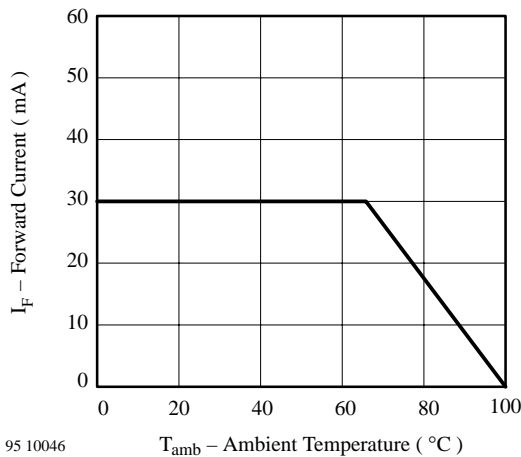

Figure 2. Forward Current vs. Ambient Temperature

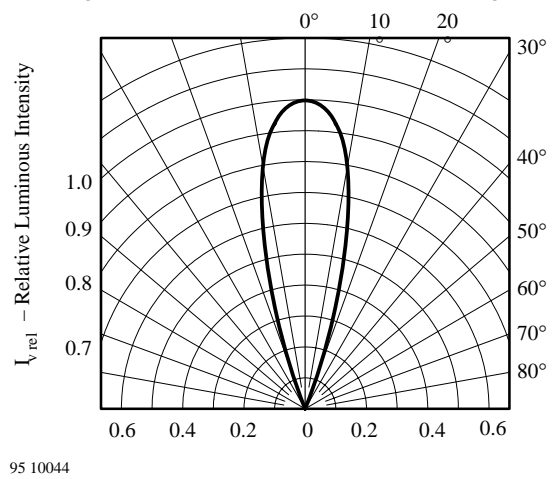
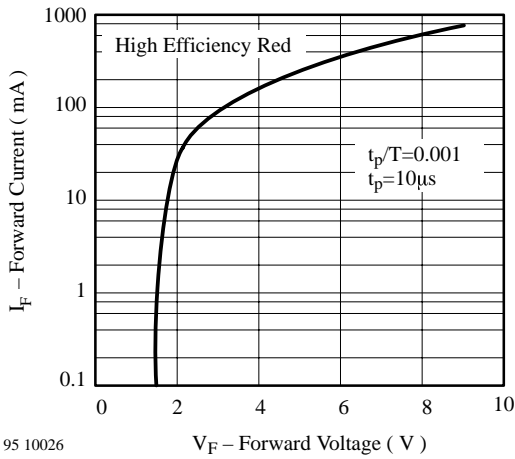
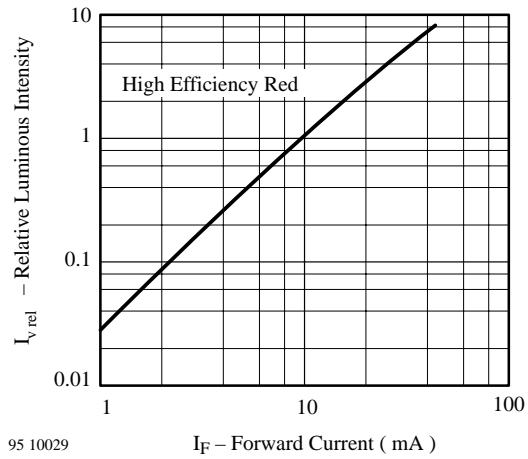

Figure 4. Rel. Luminous Intensity vs. Angular Displacement



95 10026

Figure 5. Forward Current vs. Forward Voltage



95 10029

Figure 8. Relative Luminous Intensity vs. Forward Current

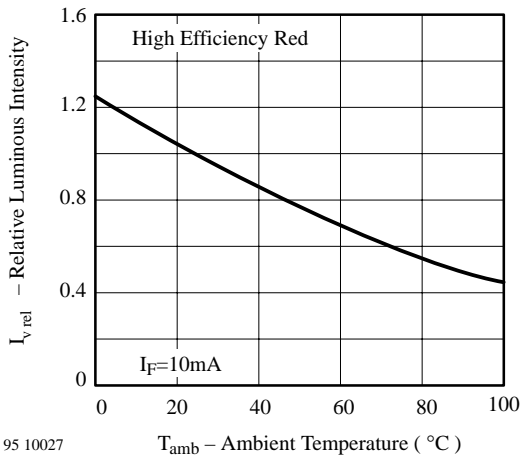

95 10027

Figure 6. Rel. Luminous Intensity vs. Ambient Temperature

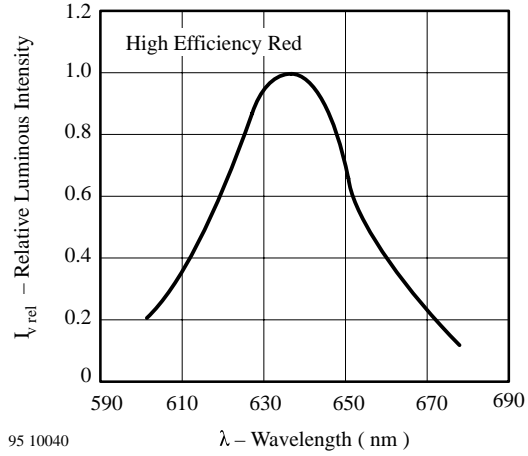

95 10040

Figure 9. Relative Luminous Intensity vs. Wavelength

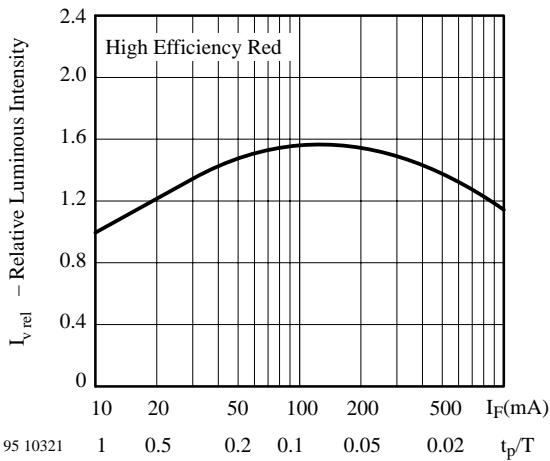

95 10321

Figure 7. Rel. Lumin. Intensity vs. Forw. Current/Duty Cycle

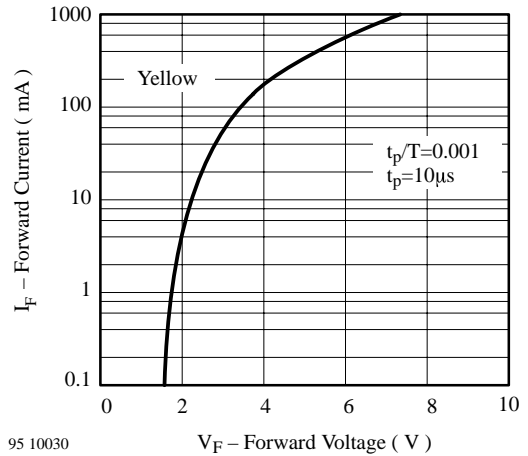

95 10030

Figure 10. Forward Current vs. Forward Voltage

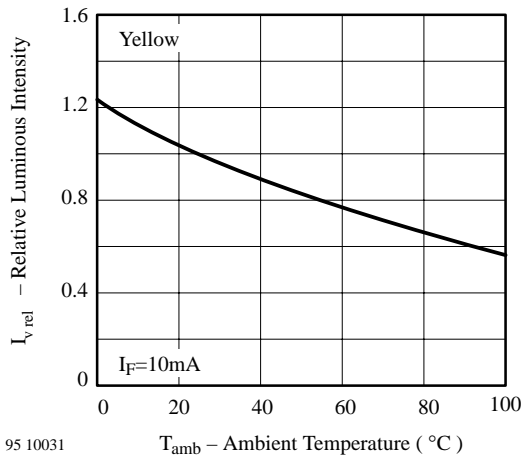

95 10031

Figure 11. Rel. Luminous Intensity vs. Ambient Temperature

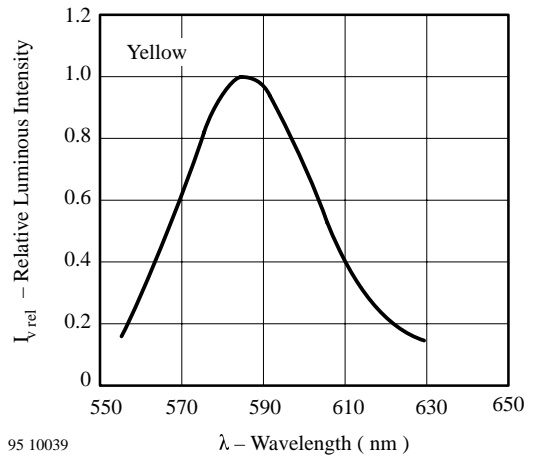

95 10039

Figure 14. Relative Luminous Intensity vs. Wavelength

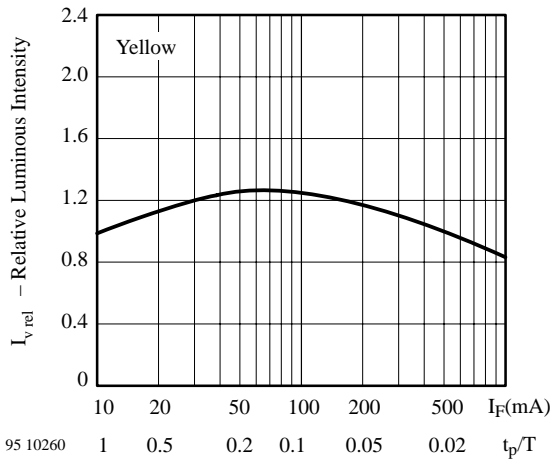

95 10260

Figure 12. Rel. Lumin. Intensity vs. Forw. Current/Duty Cycle

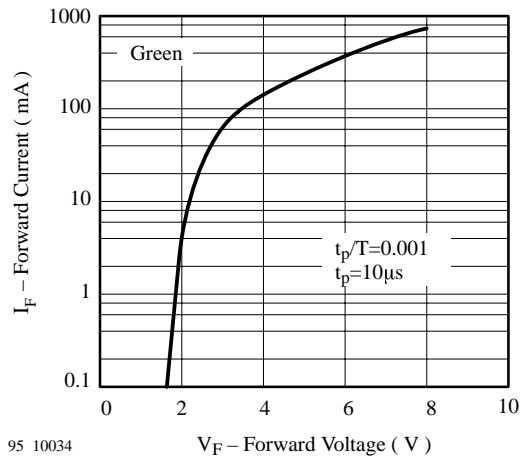

95 10034

Figure 15. Rel. Luminous Intensity vs. Ambient Temperature

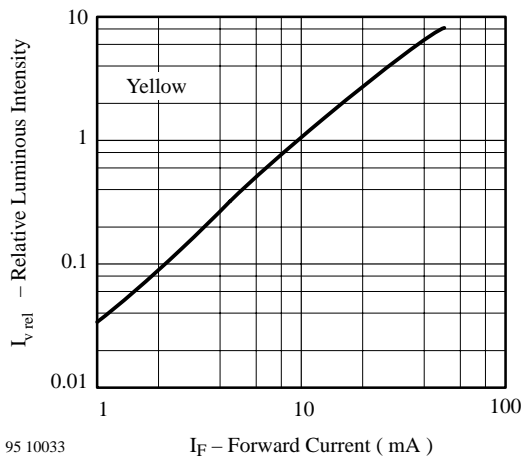

95 10033

Figure 13. Relative Luminous Intensity vs. Forward Current

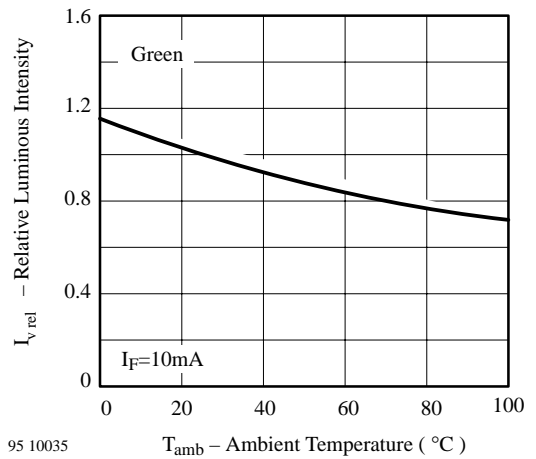

95 10035

Figure 16. Rel. Luminous Intensity vs. Ambient Temperature

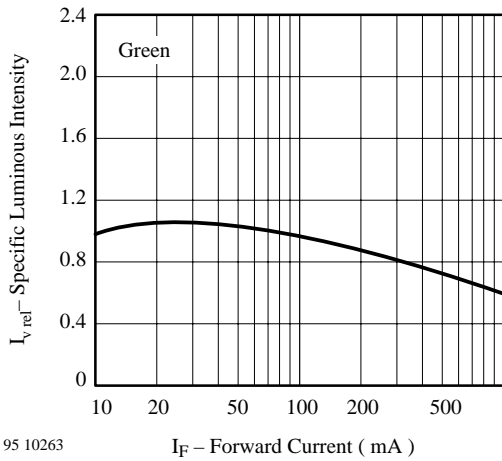

Figure 17. Specific Luminous Intensity vs. Forward Current

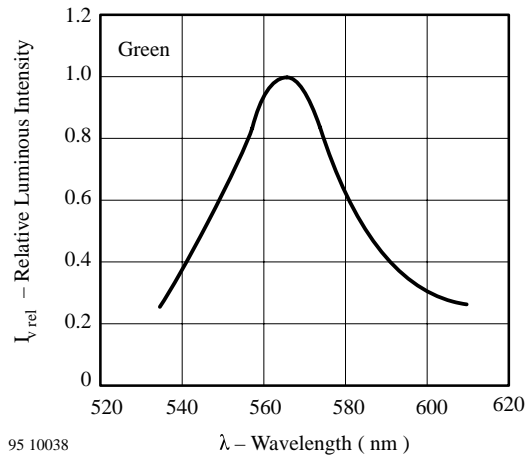

Figure 19. Relative Luminous Intensity vs. Wavelength

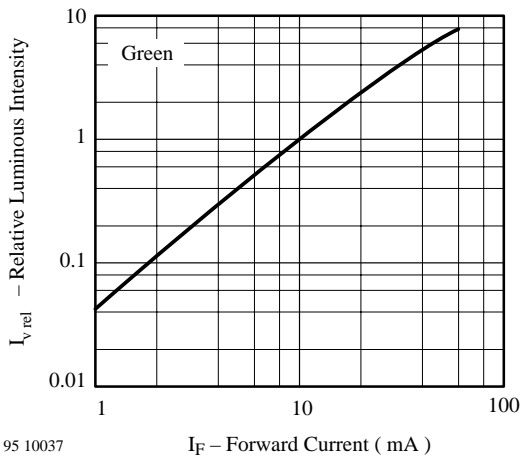
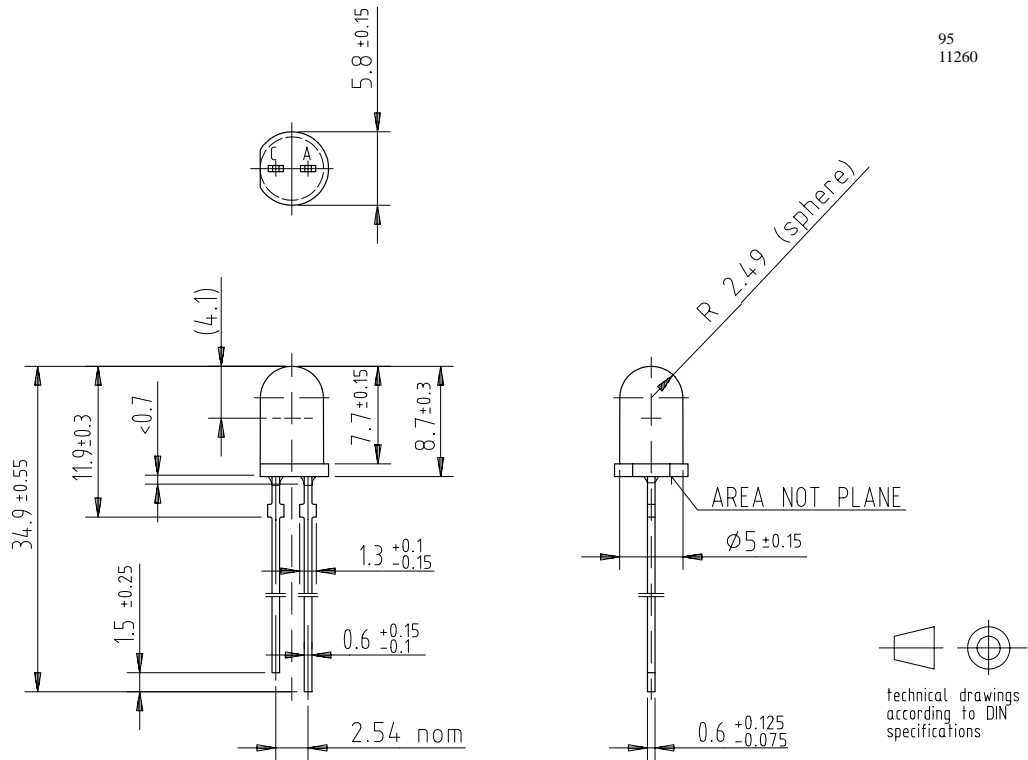

Figure 18. Relative Luminous Intensity vs. Forward Current

Dimensions in mm

Package TLH.52..



95
11260

Package TLH.62..

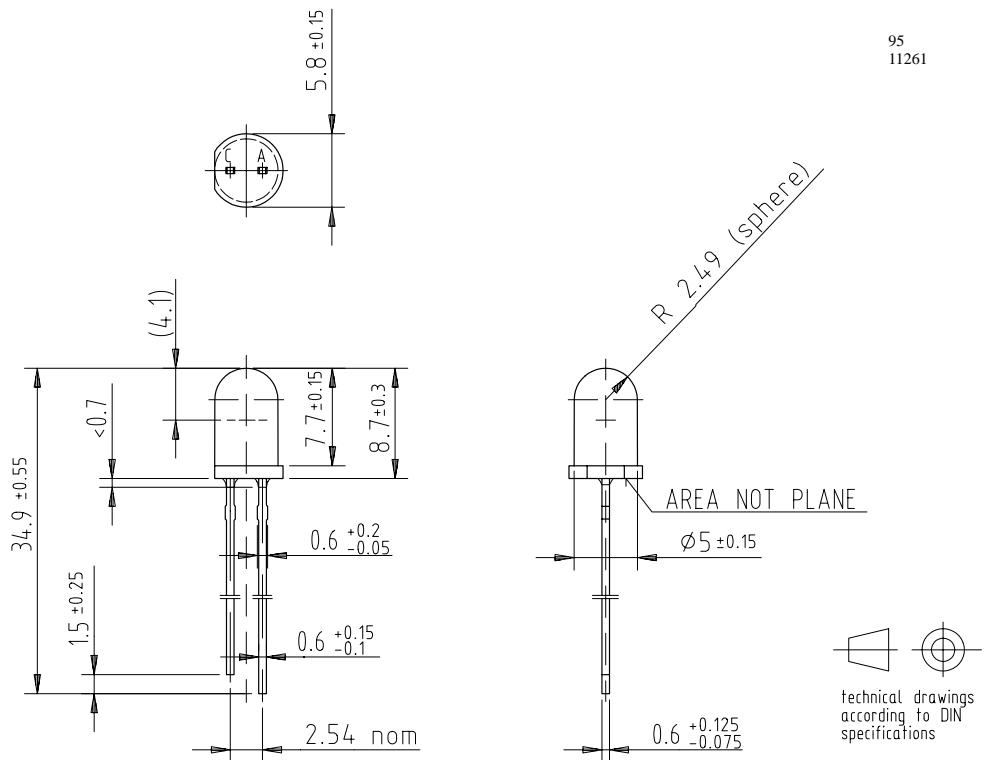

95
11261

Ozone Depleting Substances Policy Statement

It is the policy of **Vishay Semiconductor GmbH** to

1. Meet all present and future national and international statutory requirements.
2. Regularly and continuously improve the performance of our products, processes, distribution and operating systems with respect to their impact on the health and safety of our employees and the public, as well as their impact on the environment.

It is particular concern to control or eliminate releases of those substances into the atmosphere which are known as ozone depleting substances (ODSs).

The Montreal Protocol (1987) and its London Amendments (1990) intend to severely restrict the use of ODSs and forbid their use within the next ten years. Various national and international initiatives are pressing for an earlier ban on these substances.

Vishay Semiconductor GmbH has been able to use its policy of continuous improvements to eliminate the use of ODSs listed in the following documents.

1. Annex A, B and list of transitional substances of the Montreal Protocol and the London Amendments respectively
2. Class I and II ozone depleting substances in the Clean Air Act Amendments of 1990 by the Environmental Protection Agency (EPA) in the USA
3. Council Decision 88/540/EEC and 91/690/EEC Annex A, B and C (transitional substances) respectively.

Vishay Semiconductor GmbH can certify that our semiconductors are not manufactured with ozone depleting substances and do not contain such substances.

We reserve the right to make changes to improve technical design and may do so without further notice.

Parameters can vary in different applications. All operating parameters must be validated for each customer application by the customer. Should the buyer use Vishay-Telefunken products for any unintended or unauthorized application, the buyer shall indemnify Vishay-Telefunken against all claims, costs, damages, and expenses, arising out of, directly or indirectly, any claim of personal damage, injury or death associated with such unintended or unauthorized use.

Vishay Semiconductor GmbH, P.O.B. 3535, D-74025 Heilbronn, Germany
Telephone: 49 (0) 7131 67 2831, Fax number: 49 (0) 7131 67 2423