

THERMOCOUPLES: TYPE JTCT A

WITH TRANSITION JUNCTION TUBE

DESCRIPTION:

Sheathed thermocouple with extension wires. Sheath/wire transition junction enclosed in stainless steel tube.

FEATURES:

- Designed for plastic moulding machines
- Wide range of mounting accessories available

DATA:

Sensing element Single element
 thermocouple type J
Maximum temperature 600°C (sensor)
 200°C (transition junction)
Construction Densely packed MgO insulation
 Ungrounded hot junction
Minimum bending radius 3 x d
Sheath material AISI 304
Diameter d 1 or 1.5 mm
Insulation resistance 100MΩ at 100V d.c.
Extension cable Type J solid wires
 2 x 0.5mm (24 AWG)
 Single conductor
 Overall Kapton insulation
 Outer size flat 1.5 x 2 .5mm
 Colour coding to IEC 584
Length L 50 - 500mm
Cable length E 1000 - 3000mm

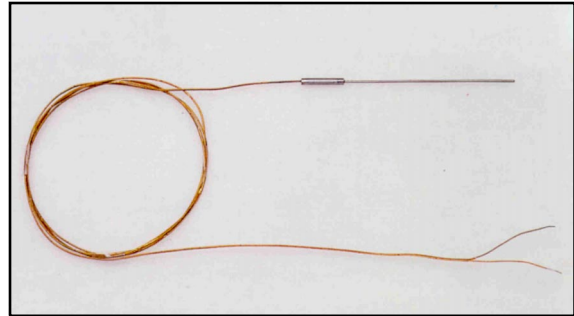

DIMENSIONS:

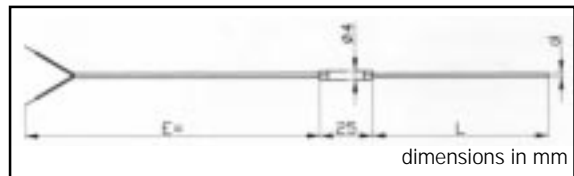

CODING:

e.g. JTCTA15S750C202

Example	Description	Code	Values
TCT A	Type		
15	Diameter d mm	10	1.0
		15	1.5
75	Length L mm	50	50
		75	75
		100	100
		125	125
		150	150
		175	175
		200	200
		250	250
		300	300
		350	350
		400	400
2000	Cable length E mm	450	450
		500	500
		1000	1000
		2000	2000
		3000	3000

Datasheet D-JTCTA-1

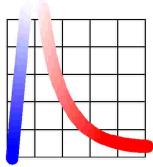

THERMOCOUPLES: TYPE JTCT B/C

TYPE J FOR PLASTIC PROCESSING

DESCRIPTION:

Sheathed thermocouples with extension wires

FEATURES:

- Designed for plastic moulding machines
- Wide range of mounting accessories available
- Coil wound version available for variable lengths

DATA:

Sensing element ... Single thermocouple type J

Maximum temperature 600°C (sensor)

..... 120°C (termination)

Construction Densely packed MgO insulation

..... Ungrounded hot junction

Minimum bending radius 3 x d

Sheath material AISI 304

Diameter d 1 or 1.5mm

Length L 500 - 1500mm

TCT B

Termination Moulded polarised plug

..... Harting connector pitch

TCT C

Transition Junction Stainless steel tube

Termination Two solid wires 1.3mm O.D.

CODING:

e.g. JTCTB10S102M

Example	Description	Code	Values
JTCT	Type		
B	Termination	B C	Plug Wire
10	Sheath Diameter d mm	10	1.0
		15	1.5
S102	Sheath length L mm	501	500
		751	750
		102	1000
		122	1250
		152	1500
M	Configuration	X	Standard
		M	Coil wound

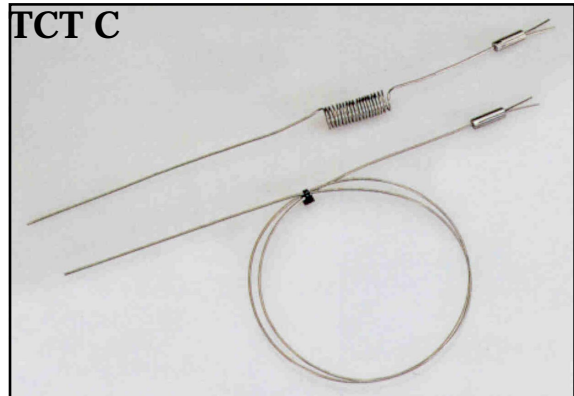
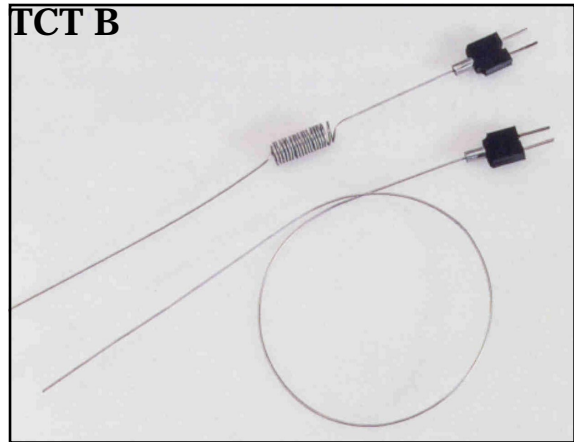

DIMENSIONS:

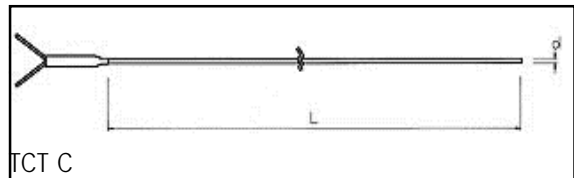
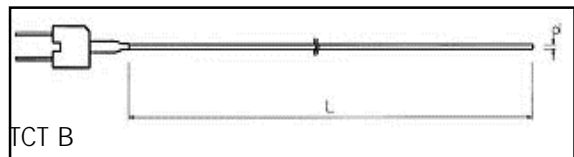

Datasheet D-JTCB/C-1

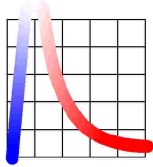

THERMOCOUPLES: TYPE JTCT

MOUNTING ACCESSORIES

DESCRIPTION:

A range of easy to use mounting accessories for the Thermometrics range of thermocouple assemblies.

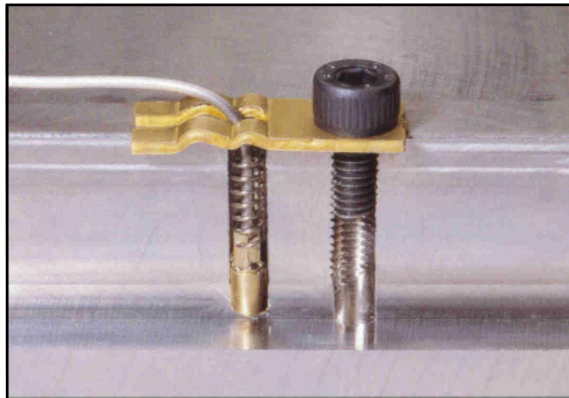

CLAMPING PLATE:

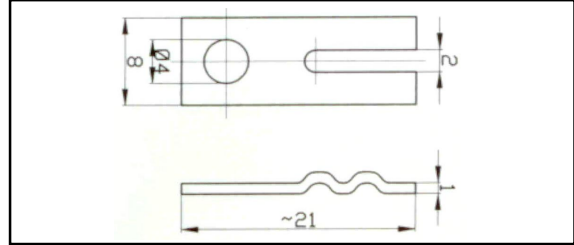

Material Brass
Code AMECO20

CRIMPING TIP:

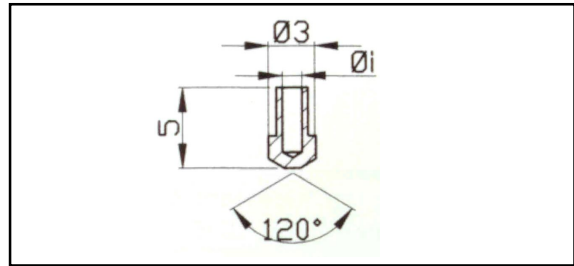

Material Nickel-plated brass
Codes PUNP3010X (1mm Dia)
..... PUNP3015X (1.5mm dia)

SPRING:

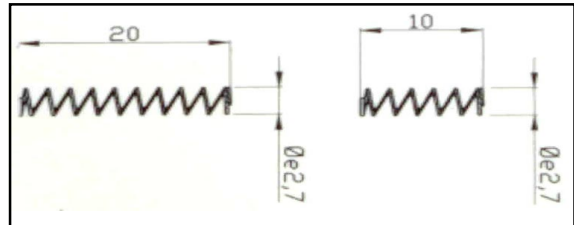

Material Spring steel
Code MOLLA015 (10mm length)
..... MOLLA014 (20mm length)

SCREW:

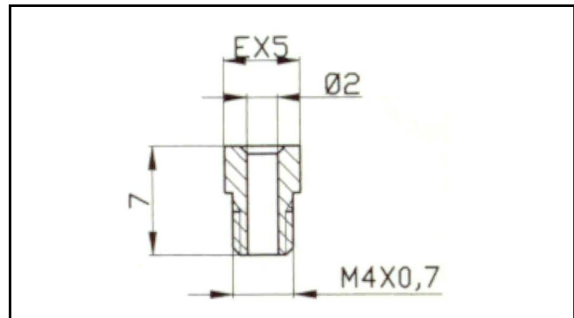

Material Brass
Code VITE007

All dimension in mm

Data sheet D-JTCT-1