

## HW025 Dual Positive Output-Series Power Modules: dc-dc Converter: 36 Vdc to 75 Vdc Input, Dual Positive Outputs; 25 W

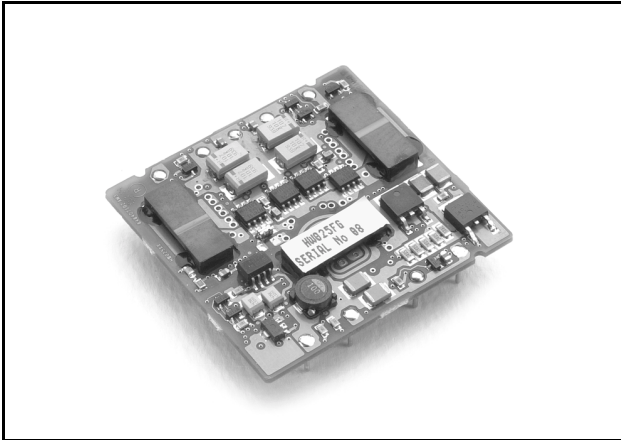

The HW025 Dual Positive Output-Series Power Modules use advanced, surface-mount technology and deliver high-quality, efficient, and compact dc-dc conversion.

### Applications

- Distributed power architectures
- Communications equipment
- Computer equipment

### Options

- Remote on/off logic choice (positive or negative)

### Description

The HW025 Dual Positive Output-Series Power Modules are open frame dc-dc converters that operate over an input voltage range of 36 Vdc to 75 Vdc and provide precisely regulated dual positive outputs. The modules have a maximum power rating of 25 W at a typical full-load efficiency of 80%. The HW025 Dual Positive Output-Series provides two independently regulated outputs. The circuit architecture allows power to be traded between the two outputs, while maintaining a high efficiency.

### Features

- Low profile
- Small size: 54.4 mm x 57.4 mm x 7.5 mm  
(2.14 in. x 2.26 in. x 0.29 in.)
- High efficiency: 80% typical
- Two tightly regulated outputs
- Flexible current allocation between outputs
- Fixed frequency
- Remote on/off
- Output voltage adjustment (trim)
- Output overcurrent protection
- Overtemperature protection
- Meets the voltage isolation requirements for ETSI 300-132-2 and complies with and is Licensed for Basic Insulation rating per EN60950.
- Wide operating temperature range (–40 °C to 90 °C)
- *UL*\* 1950 Recognized, *CSA*† C22.2 No. 950-95 Certified, and *VDE*‡ 0805 (EN60950, IEC950) Licensed
- CE mark meets 73/23/EEC and 93/68/EEC directives§

\* *UL* is a registered trademark of Underwriters Laboratories, Inc.

† *CSA* is a registered trademark of Canadian Standards Association.

‡ *VDE* is a trademark of Verband Deutscher Elektrotechniker e.V.

§ This product is intended for integration into end-use equipment. All the required procedures for CE marking of end-use equipment should be followed. (The CE mark is placed on selected products.)

## Absolute Maximum Ratings

Stresses in excess of the absolute maximum ratings can cause permanent damage to the device. These are absolute stress ratings only. Functional operation of the device is not implied at these or any other conditions in excess of those given in the operations sections of the data sheet. Exposure to absolute maximum ratings for extended periods can adversely affect device reliability.

Parameter	Symbol	Min	Max	Unit
Input Voltage: Continuous	$V_I$	—	80	Vdc
Transient (2ms)	$V_{I, trans}$	—	100	V
Operating Ambient Temperature (See Thermal Considerations section.)	$T_A$	-40	90	°C
Storage Temperature	$T_{stg}$	-55	125	°C
I/O Isolation Voltage	—	—	1500	Vdc

## Electrical Specifications

Unless otherwise indicated, specifications apply over all operating input voltage, resistive load, and temperature conditions.

**Table 1. Input Specifications**

Parameter	Symbol	Min	Typ	Max	Unit
Operating Input Voltage	$V_I$	36	48	75	Vdc
Maximum Input Current ( $V_I = 0$ V to 75 V; $I_o = I_{o, max}$ ; see Figures 1 and 2.)	$I_{I, max}$	—	—	1.0	A
Inrush Transient	—	—	—	1.0	A <sup>2</sup> s
Input Reflected-ripple Current, Peak-to-peak (5 Hz to 20 MHz, 12 $\mu$ H source impedance; see Figure 15.)	$I_I$	—	4	—	mAp-p
Input Ripple Rejection (120 Hz)	—	—	54	—	dB
EMC, EN55022 ( $V_I, nom$ , full load)	See EMC Considerations section.				

## Fusing Considerations

**CAUTION: This power module is not internally fused. An input line fuse must always be used.**

This power module can be used in a wide variety of applications, ranging from simple stand-alone operation to an integrated part of a sophisticated power architecture. To preserve maximum flexibility, internal fusing is not included; however, to achieve maximum safety and system protection, always use an input line fuse. The safety agencies require a normal-blow fuse with a maximum rating of 3 A (see Safety Considerations section). Based on the information provided in this data sheet on inrush energy and maximum dc input current, the same type of fuse with a lower rating can be used. Refer to the fuse manufacturer's data for further information.

## Electrical Specifications (continued)

Table 2. Output Specifications

Parameter	Device	Symbol	Min	Typ	Max	Unit
Output Voltage Set Point ( $V_I = 48\text{ V}$ ; $I_O = I_{O, \text{max}}$ ; $T_A = 25\text{ }^\circ\text{C}$ )	HW025AF	$V_{O1, \text{set}}$	4.92	5.00	5.08	Vdc
		$V_{O2, \text{set}}$	3.25	3.30	3.35	Vdc'
	HW025FG	$V_{O1, \text{set}}$	3.25	3.30	3.35	Vdc
		$V_{O2, \text{set}}$	2.46	2.50	2.54	Vdc
Output Voltage (Over all operating input voltage, resistive load, and temperature conditions until end of life.)	HW025AF	$V_{O1}$	4.78	—	5.21	Vdc
		$V_{O2}$	3.16	—	3.44	Vdc
	HW025FG	$V_{O1}$	3.16	—	3.44	Vdc
		$V_{O2}$	2.42	—	2.58	Vdc
Output Regulation: Line ( $V_I = 36\text{ V to } 75\text{ V}$ ) Load ( $I_O = I_{O, \text{min}}$ to $I_{O, \text{max}}$ ) Temperature ( $T_A = -40\text{ }^\circ\text{C to } +70\text{ }^\circ\text{C}$ )	All	—	—	0.01	0.2	% $V_O$
	All	—	—	0.05	0.2	% $V_O$
	All	—	—	15	50	mV
Output Ripple and Noise Voltage (see Figures 9 and 16): RMS (5 Hz to 20 MHz bandwidth)	All	—	—	—	30	mVrms
		—	—	70	100	mVp-p
Peak-to-peak (5 Hz to 20 MHz bandwidth)						
External Load Capacitance	All	—	0	—	*	$\mu\text{F}$
Output Current	All	$I_{O1}$	0.0	—	4.0	Adc
	All	$I_{O2}$	0.0	—	4.0	Adc
Output Current-limit Inception ( $V_O = 90\%$ of $V_{O, \text{nom}}$ )	HW025AF	$I_{O, \text{cli}}$	—	—	$9^\dagger$	A
	HW025FG	$I_{O, \text{cli}}$	—	—	$9^\dagger$	A
Output Short-circuit Current ( $V_O = 250\text{ mV}$ )	HW025AF	$I_{O, \text{SL}}$	—	10	—	% $I_{O, \text{max}}$
	HW025FG	$I_{O, \text{SL}}$	—	10	—	% $I_{O, \text{max}}$
Efficiency for $V_{O1} = 5.0\text{ V}$ , $V_{O2} = 3.3\text{ V}$ ( $V_I = 48\text{ V}$ , $I_{O1} = I_{O2} = 2.5\text{ A}$ , $T_{\text{ref}} = 25\text{ }^\circ\text{C}$ )	HW025AF	$\eta$	78	81	—	%
	HW025FG	$\eta$	76	80	—	%
for $V_{O1} = 3.3\text{ V}$ , $V_{O2} = 2.5\text{ V}$ ( $V_I = 48\text{ V}$ , $I_{O1} = I_{O2} = 2.5\text{ A}$ , $T_{\text{ref}} = 25\text{ }^\circ\text{C}$ )						
Switching Frequency	All	—	—	300	—	kHz

\* Consult your sales representative or the factory.

† These are manufacturing test limits. In some situations, results may differ.

## Electrical Specifications (continued)

Table 2. Output Specifications (continued)

Parameter	Device	Symbol	Min	Typ	Max	Unit
Dynamic Response ( $\Delta I_o/\Delta t = 1 \text{ A}/10 \mu\text{s}$ , $V_I = 48 \text{ V}$ , $T_{\text{ref}} = 25 \text{ }^\circ\text{C}$ ):						
Load Change from $I_{O1} = 50\%$ to $75\%$ of $I_{O1, \text{max}}$ , $I_{O2} = 30\%$ of $I_{O2, \text{max}}$ :						
Peak Deviation	All	—	—	100	—	mV
Settling Time ( $V_o < 10\%$ of peak deviation)	All	—	—	2000	—	$\mu\text{s}$
Load Change from $I_{O1} = 50\%$ to $25\%$ of $I_{O1, \text{max}}$ , $I_{O2} = 30\%$ of $I_{O2, \text{max}}$ :						
Peak Deviation	All	—	—	100	—	mV
Settling Time ( $V_o < 10\%$ of peak deviation)	All	—	—	2000	—	$\mu\text{s}$

## Isolation Specifications

Parameter	Min	Typ	Max	Unit
Isolation Capacitance	—	0.2	—	nF
Isolation Resistance	10	—	—	M $\Omega$

## General Specifications

Parameter	Min	Typ	Max	Unit
Calculated MTBF ( $I_o = 80\%$ of $I_{o, \text{max}}$ ; $T_A = 20 \text{ }^\circ\text{C}$ )				
HW025AF		4,000,000		hours
HW025FG		4,900,000		hours
Weight	—	—	23 (0.81)	g (oz.)

## Solder Ball and Cleanliness Requirements

The open frame (no case or potting) power module will meet the solder ball requirements per J-STD-001B. These requirements state that solder balls must neither be loose nor violate the power module minimum electrical spacing.

The cleanliness designator of the open frame power module is C00 (per J specification).

## Solder, Cleaning and Drying Considerations

Post solder cleaning is usually the final circuit-board assembly process prior to electrical board testing. The result of inadequate circuit-board cleaning and drying can affect both the reliability of a power module and the testability of the finished circuit-board assembly. For guidance on appropriate soldering, cleaning, and drying procedures, refer to the *Board-Mounted Power Modules Soldering and Cleaning* Application Note (AP97-021EPS).

## Feature Specifications

Unless otherwise indicated, specifications apply over all operating input voltage, resistive load, and temperature conditions. See Feature Descriptions for additional information.

**Table 3. Feature Specifications**

Parameter	Device	Symbol	Min	Typ	Max	Unit
Remote On/Off Signal Interface ( $V_i = 0\text{ V}$ to $75\text{ V}$ ; open collector or equivalent compatible; signal referenced to $V_i(-)$ terminal; see Figure 18 and Feature Descriptions.): HW025 Preferred Negative Logic: Logic Low—Module On Logic High—Module Off HW025 Optional Positive Logic: Logic Low—Module Off Logic High—Module On Logic Low: At $I_{on/off} = 1.0\text{ mA}$ At $V_{on/off} = 0.0\text{ V}$ Logic High: At $I_{on/off} = 0.0\text{ }\mu\text{A}$ Leakage Current Turn-on Time ( $I_{o1}$ & $I_{o2} = 80\%$ of $I_{o, max}$ ; $V_{o1}$ or $V_{o2}$ within $\pm 1\%$ of steady state; see Figure 13.)	— — — — — —	$V_{on/off}$ $I_{on/off}$ $V_{on/off}$ $I_{on/off}$ — —	0 — — — — —	— — — — 15 10	1.2 1.0 15 50 — —	V mA V $\mu\text{A}$ ms ms
Output Voltage Adjustment Range (trim), each output:  <b>Note:</b> There are restrictions to the combinations of output voltage. See Output Voltage Adjustment Section.	HW025AF  HW025FG	$V_{o1}$ $V_{o2}$  $V_{o1}$ $V_{o2}$	76  76 60	— — — —	105 105 105 105	%V %V %V %V
Output Overvoltage Protection	HW025AF HW025FG	$V_{o1}$ $V_{o1}$	5.6* 3.5*	— —	7.0* 4.0*	V V
Overtemperature Protection	All	$T_{ref}$	—	120	—	$^{\circ}\text{C}$

\* Engineering estimate.

## Characteristic Curves

The following figures provide typical characteristics for the power modules. The figures are identical for both on/off configurations.

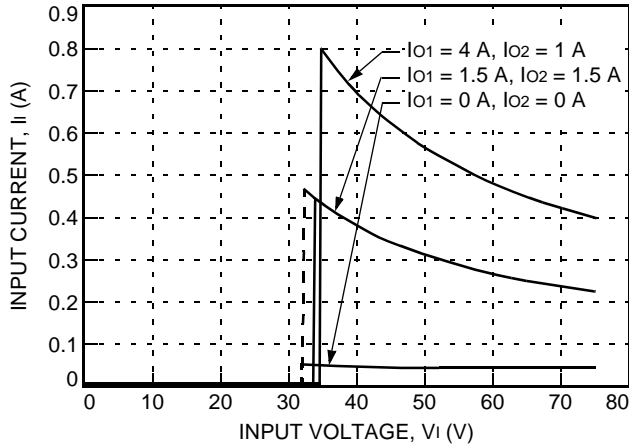

8-3301 (F)

Figure 1. Typical HW025AF Input Characteristics at Room Temperature

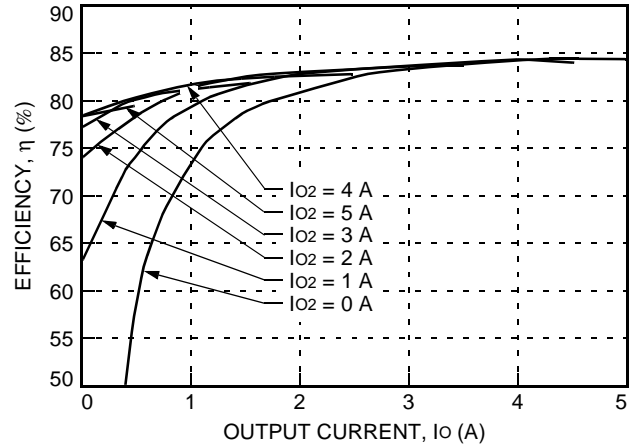

8-3302 (F)

Figure 3. Typical HW025AF Converter Efficiency vs. Output Current at  $V_i = 36$  V

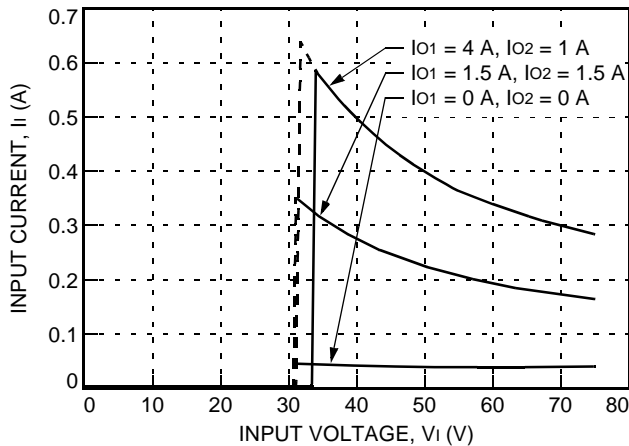

8-3289 (F)

Figure 2. Typical HW025FG Input Characteristics at Room Temperature

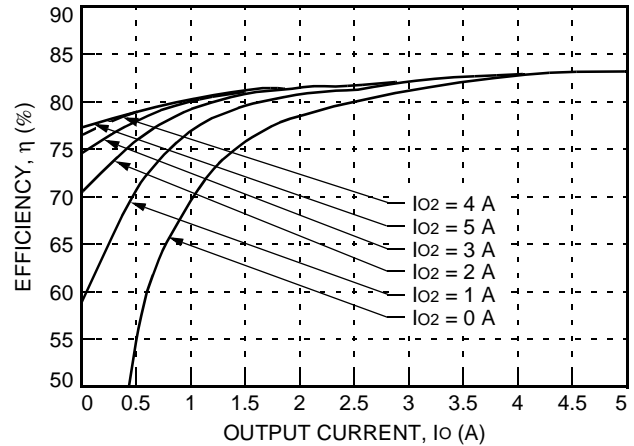

8-3303 (F)

Figure 4. Typical HW025AF Converter Efficiency vs. Output Current at  $V_i = 48$  V

Characteristic Curves (continued)

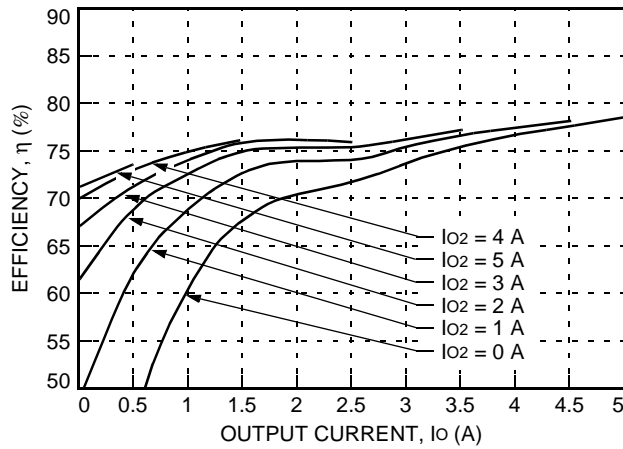

8-3304 (F)

Figure 5. Typical HW025AF Converter Efficiency vs. Output Current at  $V_i = 75\text{ V}$

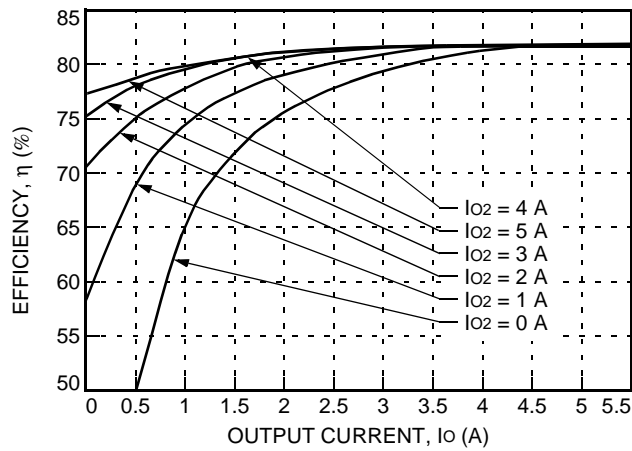

8-3290 (F)

Figure 6. Typical HW025FG Converter Efficiency vs. Output Current at  $V_i = 36\text{ V}$

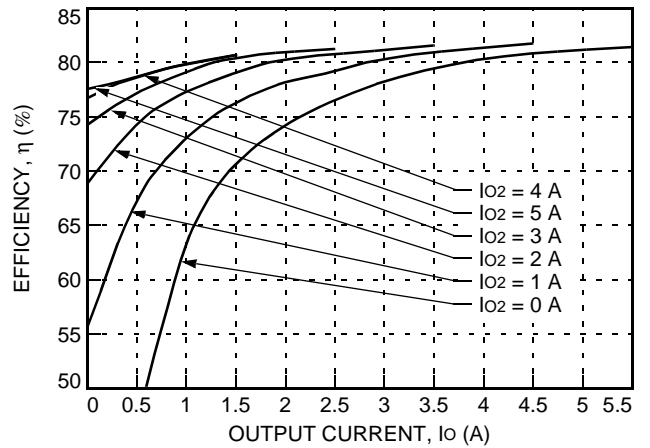

8-3291 (F)

Figure 7. Typical HW025FG Converter Efficiency vs. Output Current at  $V_i = 48\text{ V}$

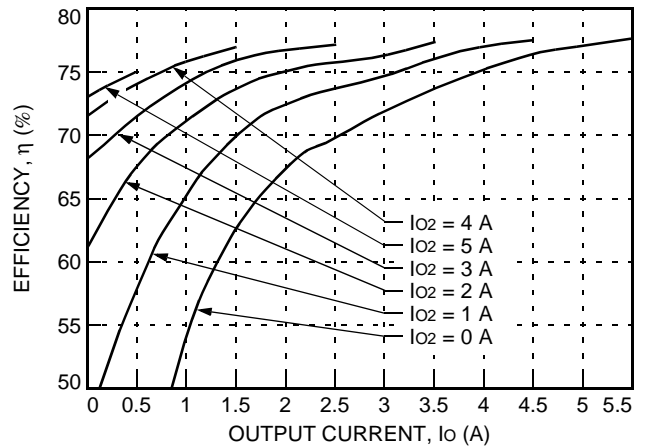

8-3292 (F)

Figure 8. Typical HW025FG Converter Efficiency vs. Output Current at  $V_i = 75\text{ V}$

Characteristic Curves (continued)

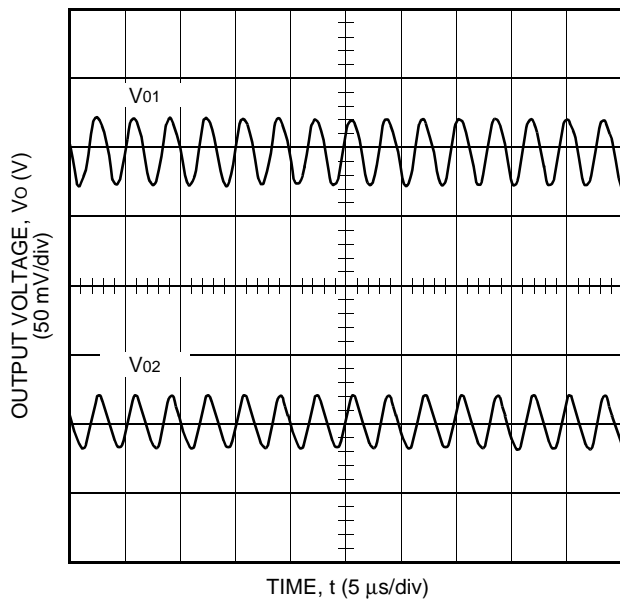

8-3308 (F)

Figure 9. Typical HW025AF Output Ripple Voltage at Room Temperature and  $I_o = I_{o, max}$

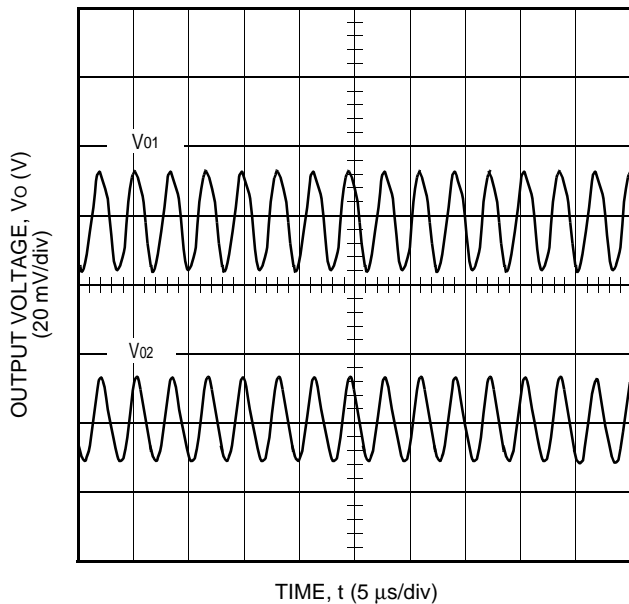

8-3293 (F)

Figure 10. Typical HW025FG Output Ripple Voltage at Room Temperature and  $I_o = I_{o, max}$

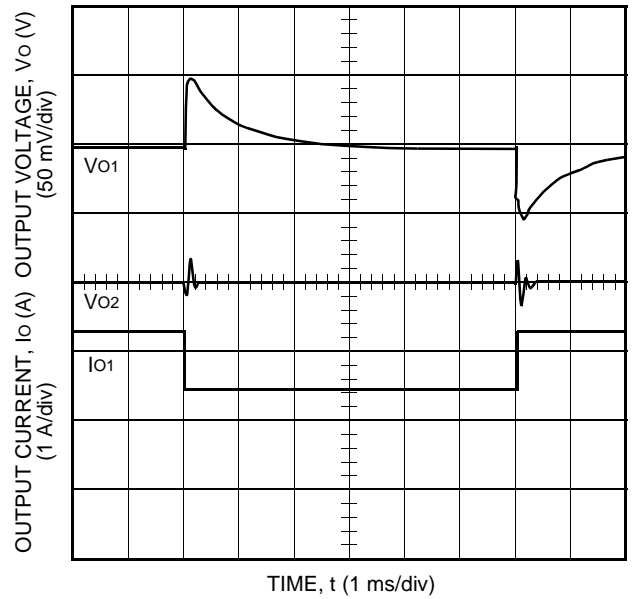

8-3310 (F)

Figure 11. Typical HW025AF Transient Response to Step Decrease in Load,  $I_o = 50\%$  to  $25\%$  of  $I_{o, max}$ , at Room Temperature and 48 V Input (Waveform Averaged to Eliminate Ripple Component.)

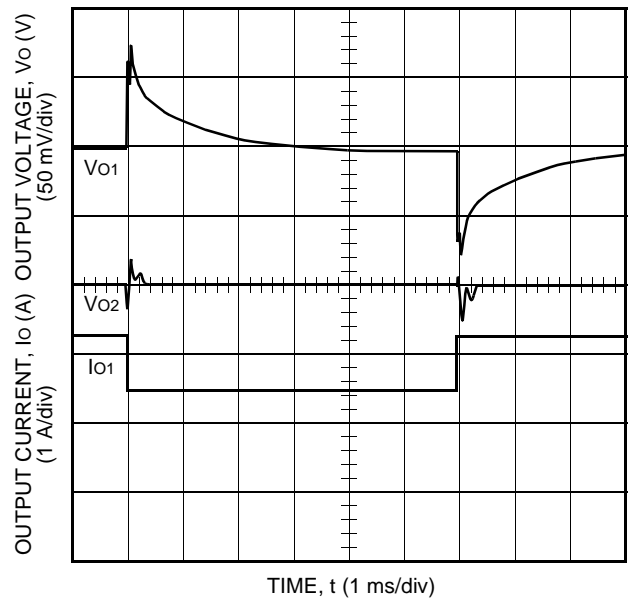

8-3311 (F)

Figure 12. Typical HW025FG Transient Response to Step Decrease in Load,  $I_o = 50\%$  to  $25\%$  of  $I_{o, max}$ , at Room Temperature and 48 V Input (Waveform Averaged to Eliminate Ripple Component.)



Characteristic Curves (continued)

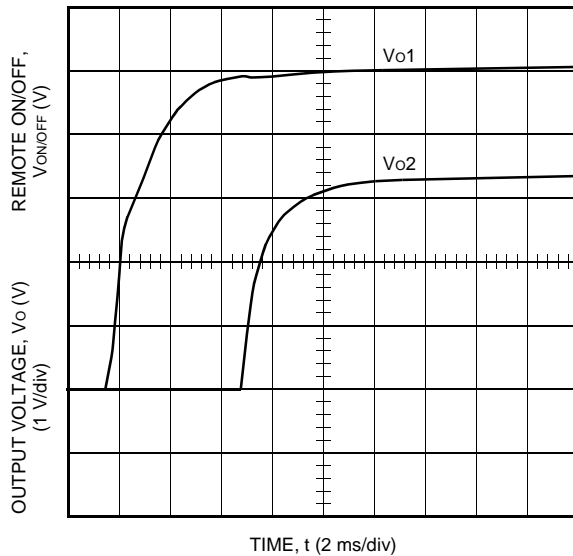

8-3401 (F)

Figure 13. Typical Start-Up from Remote On/Off HW025AF;  $I_o = I_{o, max}$

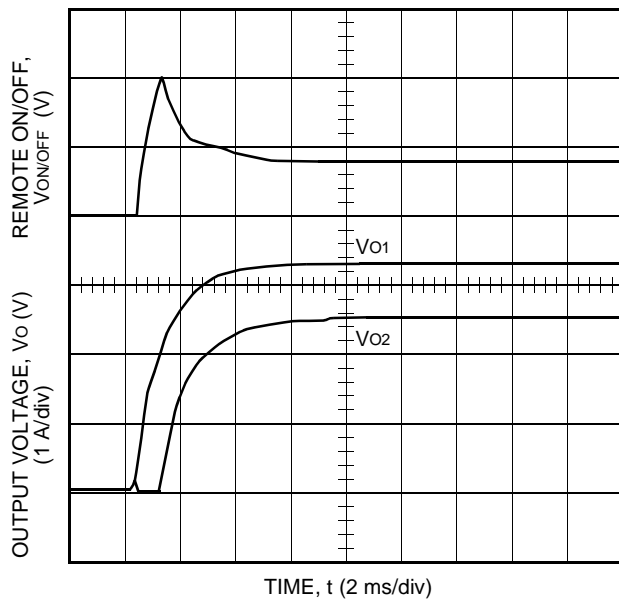

8-3295 (F)

Figure 14. Typical Start-Up from Remote On/Off HW025FG;  $I_o = I_{o, max}$

Test Configurations

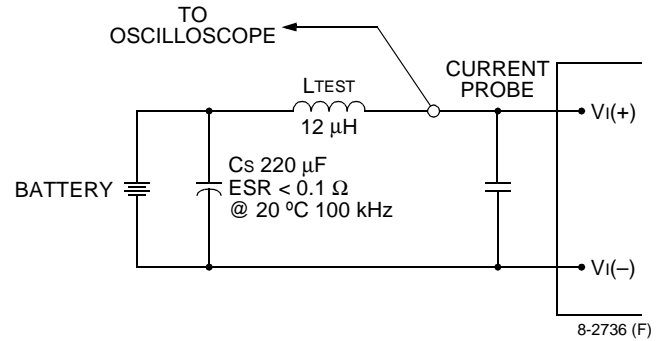

Note: Measure input reflected-ripple current with a simulated source inductance ( $L_{TEST}$ ) of 12  $\mu$ H. Capacitor  $C_s$  offsets possible battery impedance. Measure current as shown above.

Figure 15. Input Reflected-Ripple Test Setup

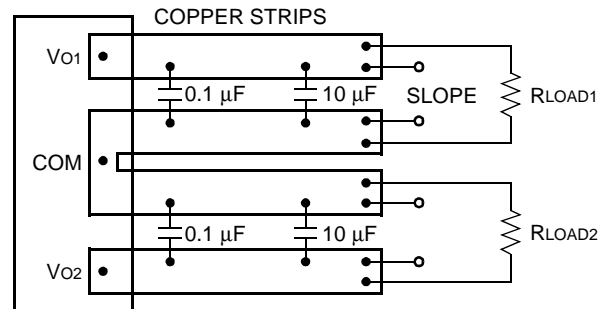

8-3299 (F)

Note: Use a 1.0  $\mu$ F ceramic capacitor and a 10  $\mu$ F aluminum or tantalum capacitor. Scope measurement should be made using a BNC socket. Position the load between 51 mm and 76 mm (2 in. and 3 in.) from the module.

Figure 16. Peak-to-Peak Output Noise Measurement Test Setup

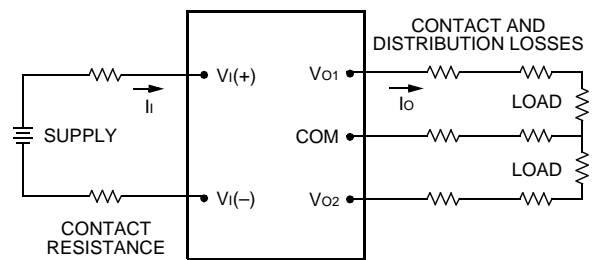

8-3300 (F)

Note: All measurements are taken at the module terminals. When socketing, place Kelvin connections at module terminals to avoid measurement errors due to socket contact resistance.

$$\eta = \frac{\sum_{j=1}^2 | [V_{Oj(+)} - V_{COM}] I_{Oj} |}{[V_{I(+)} - V_{I(-)}] I_I} \times 100 \%$$

Figure 17. Output Voltage and Efficiency Measurement Test Setup

## Design Considerations

### Input Source Impedance

The power module should be connected to a low ac-impedance input source. Highly inductive source impedances can affect the stability of the power module. For the test configuration in Figure 15, a 33  $\mu$ F electrolytic capacitor (ESR < 0.1  $\Omega$  at 100 kHz) mounted close to the power module helps ensure stability of the unit. For other highly inductive source impedances, consult the factory for further application guidelines.

### Safety Considerations

For safety-agency approval of the system in which the power module is used, the power module must be installed in compliance with the spacing and separation requirements of the end-use safety agency standard, i.e., *UL 1950*, *CSA C22.2 No. 950-95*, *VDE 0805* (EN60950, IEC950).

If the input source is non-SELV (ELV or a hazardous voltage greater than 60 Vdc and less than or equal to 75 Vdc), for the module's output to be considered meeting the requirements of safety extra-low voltage (SELV), all of the following must be true:

- The input source is to be provided with reinforced insulation from any other hazardous voltages, including the ac mains.
- One  $V_I$  pin and one  $V_O$  pin are to be grounded, or both the input and output pins are to be kept floating.
- The input pins of the module are not operator accessible.
- Another SELV reliability test is conducted on the whole system, as required by the safety agencies, on the combination of supply source and the subject module to verify that under a single fault, hazardous voltages do not appear at the module's output.

**Note:** Do not ground either of the input pins of the module without grounding one of the output pins. This may allow a non-SELV voltage to appear between the output pins and ground.

The power module has extra-low voltage (ELV) outputs when all inputs are ELV.

The input to these units is to be provided with a maximum 3 A normal-blow fuse in the ungrounded lead.

## Feature Descriptions

### Overcurrent Protection

To provide protection in a fault (output overload) condition, the unit is equipped with internal current-limiting circuitry and can endure current limiting continuously. At the point of current-limit inception, the unit shifts from voltage control to current control. The form of current-limit used is hiccup mode. The unit operates normally once the output current is brought back into its specified range. The average output current during hiccup is 10%  $I_{O, \max}$ .

### Remote On/Off

Two remote on/off options are available. Positive logic remote on/off turns the module on during a logic-high voltage on the ON/OFF pin, and off during a logic low. Negative logic remote on/off turns the module off during a logic high and on during a logic low. Negative logic, device code suffix "1", is the factory-preferred configuration.

To turn the power module on and off, the user must supply a switch to control the voltage between the on/off terminal and the  $V_I(-)$  terminal ( $V_{on/off}$ ). The switch can be an open collector or equivalent (see Figure 18). A logic low is  $V_{on/off} = 0$  V to 1.2 V. The maximum  $I_{on/off}$  during a logic low is 1 mA. The switch should maintain a logic-low voltage while sinking 1 mA.

During a logic high, the maximum  $V_{on/off}$  generated by the power module is 15 V. The maximum allowable leakage current of the switch at  $V_{on/off} = 15$  V is 50  $\mu$ A.

If not using the remote on/off feature, do one of the following:

- For negative logic, short ON/OFF pin to  $V_I(-)$ .
- For positive logic, leave ON/OFF pin open.

## Feature Descriptions (continued)

### Remote On/Off (continued)

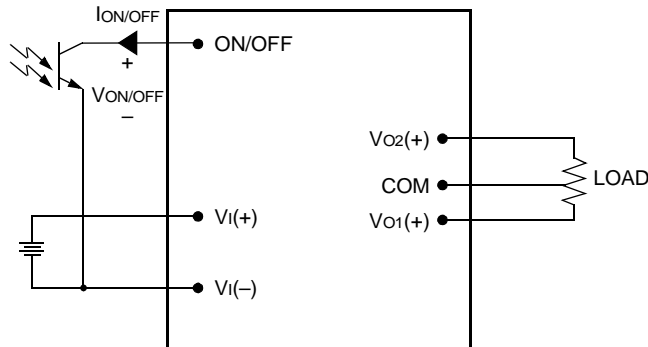

8-2800 (F)

Figure 18. Remote On/Off Implementation

### Output Voltage Set-Point Adjustment (Trim)

Output voltage set point adjustment (trim) allows the output voltage set point to be increased or decreased. The adjustment (trim) is accomplished by connecting an external resistor between the TRIM pin and either the Vo(+) pin or Vo(-) pin.

Connecting an external resistor ( $R_{trim-down}$ ) between the TRIM pin of the desired output and Vo(-) pin decreases the output voltage set point (see Figure 19). In order to maintain the output voltage accuracy, the trim resistor tolerance should be  $\pm 0.1\%$ .

The relationship between the output voltage and the trim resistor value for a  $\Delta\%$  reduction in output voltage is:

$$VO1 \quad R_{adj-down} = \left( \frac{511}{\Delta\%} - 6.11 \right) \text{ k}\Omega$$

$$VO2 \quad R_{adj-down} = \left( \frac{100}{\Delta\%} - 1.33 \right) \text{ k}\Omega$$

The test results for these configurations are displayed in Figure 20.

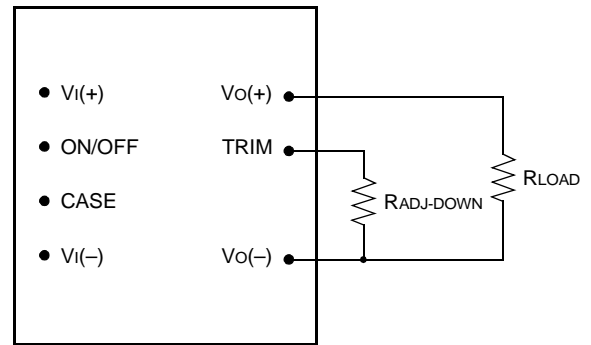

8-2739 (F)

Figure 19. Circuit Configuration to Decrease Output Voltage

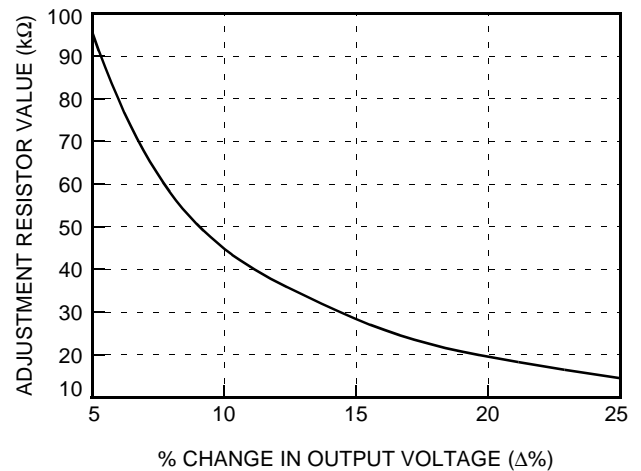

8-2680 (F)

Figure 20. Resistor Selection for Decreased Output Voltage for VO1

**Feature Descriptions** (continued)

**Output Voltage Set-Point Adjustment (Trim)** (continued)

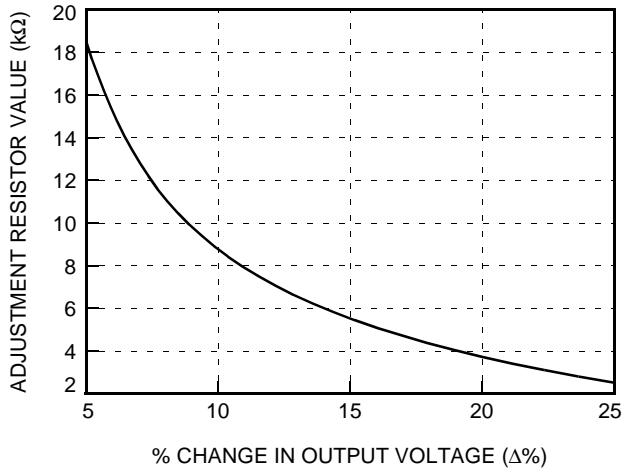

8-2681 (F)

**Figure 21. Resistor Selection for Decreased Output Voltage for V<sub>02</sub>**

Connecting an external resistor (R<sub>trim-up</sub>) between the TRIM pin and Vo(+) pin of the desired output increases the output voltage set point (see Figure 22).

The relationship between the output voltage and trim resistor value for is, V<sub>01</sub>, the 5.0 V output,

$$V_{01} \quad R_{\text{trim-up}} = \left( \frac{5.11 V_0 (100 + \Delta\%)}{1.225 \Delta\%} - \frac{511}{\Delta\%} - 6.11 \right) \text{ k}\Omega$$

and for V<sub>02</sub>, the 3.3 V output:

$$V_{02} \quad R_{\text{trim-up}} = \left( \frac{V_0 (100 + \Delta\%)}{1.225 \Delta\%} - \frac{100}{\Delta\%} - 1.33 \right) \text{ k}\Omega$$

The test results for these configurations are displayed in Figure 23.

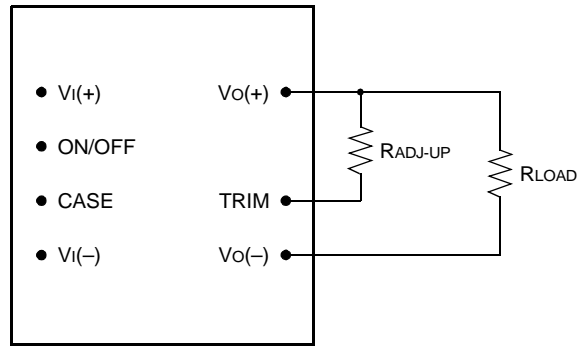

8-2740 (F)

**Figure 22. Circuit Configuration to Increase Output Voltage**

The trim resistor should be positioned close to the module.

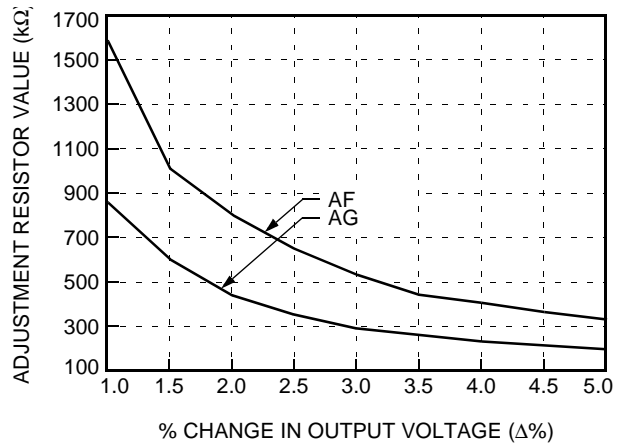

8-3093 (F)

**Figure 23. Resistor Selection for Increased Output Voltage for V<sub>01</sub>**

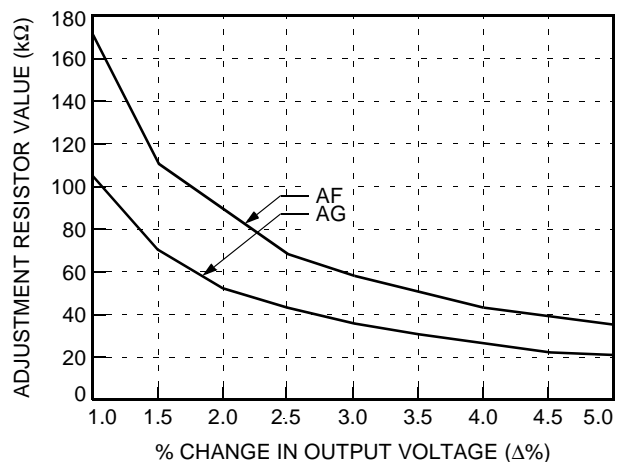

8-3094 (F)

**Figure 24. Resistor Selection for Increased Output Voltage for V<sub>02</sub>**

## Feature Descriptions (continued)

### Output Voltage Set-Point Adjustment (Trim) (continued)

If not using the trim feature, leave the TRIM pin(s) open.

**Note:** The following voltage range restrictions apply:

#### HW025AF

For  $V_{O1}$  set to 5.0 V  
 $V_{O2}$  range is 2.5 V to 3.3 V

#### HW025FG

For  $V_{O1}$  set to 3.3 V  
 $V_{O2}$  range is 1.5 V to 2.5 V

For  $V_{O1}$  set to 2.5 V  
 $V_{O2}$  range is 1.5 V to 2.0 V

### Output Overvoltage Protection

The output overvoltage protection consists of circuitry that monitors the voltage on the output main terminals. If the voltage on the output terminals exceeds the overvoltage protection threshold, then the module will shut down and attempt to restart.

### Overtemperature Protection

To provide protection in a fault condition, the unit is equipped with a thermal shutdown circuit. The shutdown circuit will not engage unless the unit is operated above the maximum sensor temperature. Recovery from the thermal shutdown is automatic.

### Thermal Considerations

The power modules operate in a variety of thermal environments; however, sufficient cooling should be provided to help ensure reliable operation of the unit. Heat is removed by convection and radiation to the surrounding environment.

Considerations include ambient temperature, amount of airflow, module power dissipation, and need for increased reliability.

The monitor temperature reference point,  $T_{ref}$  referenced in the specifications as shown in Figure 25.

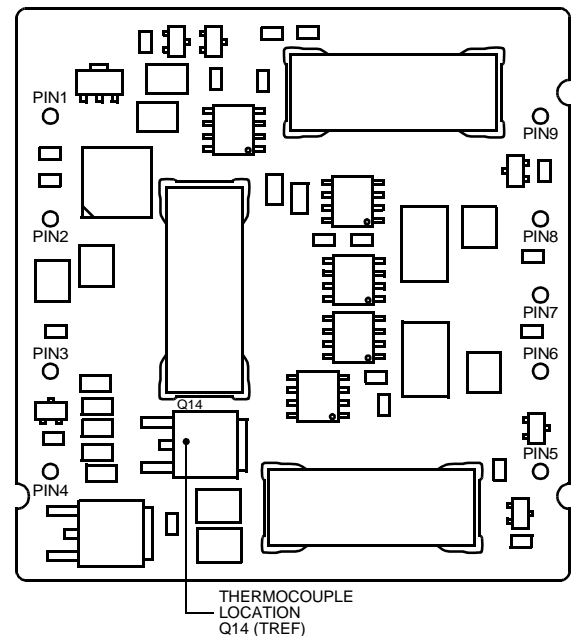

8-3402 (F).a

Figure 25.  $T_{ref}$  Temperature Measurement Location

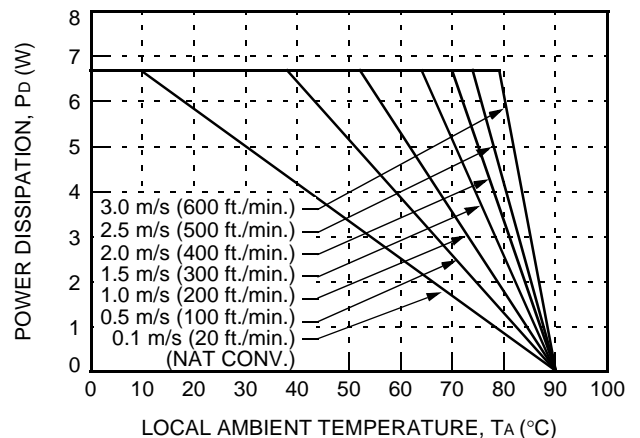

8-3403 (F)

Figure 26. HW025AF Forced Convection Power Derating with No Heat Sink; Either Orientation

Thermal Considerations (continued)

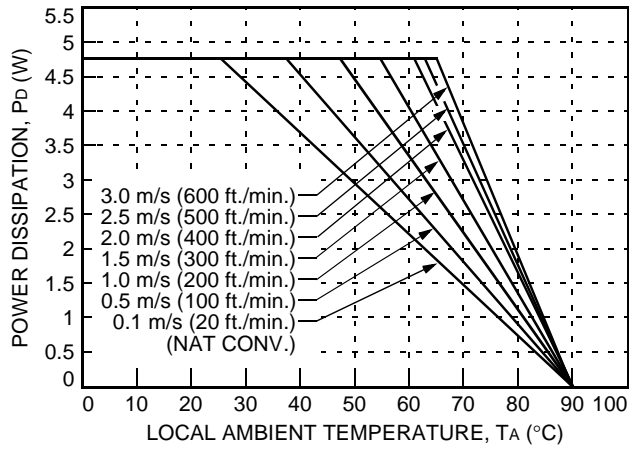

8-3312 (F)

Figure 27. HW025FG Forced Convection Power Derating with No Heat Sink; Either Orientation

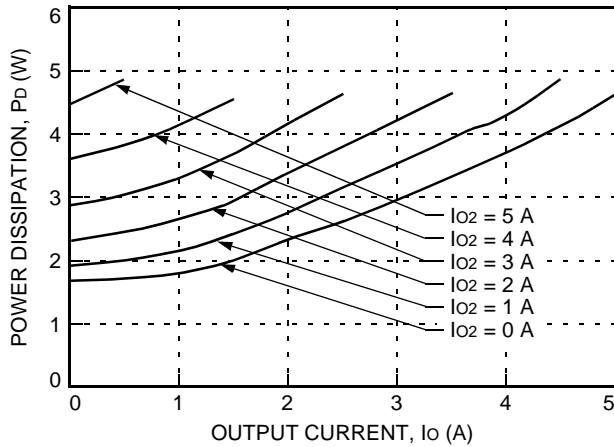

8-33305 (F)

Figure 28. HW025AF Power Dissipation vs. Output Current at  $V_i = 36\text{ V}$

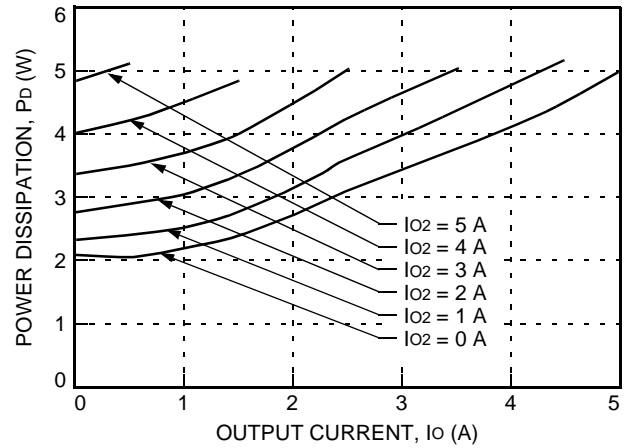

8-3306 (F)

Figure 29. HW025AF Power Dissipation vs. Output Current at  $V_i = 48\text{ V}$

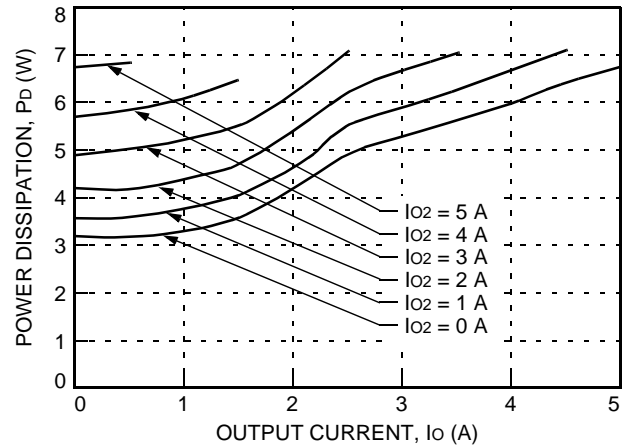

8-3307 (F)

Figure 30. HW025AF Power Dissipation vs. Output Current at  $V_i = 75\text{ V}$

**Thermal Considerations** (continued)

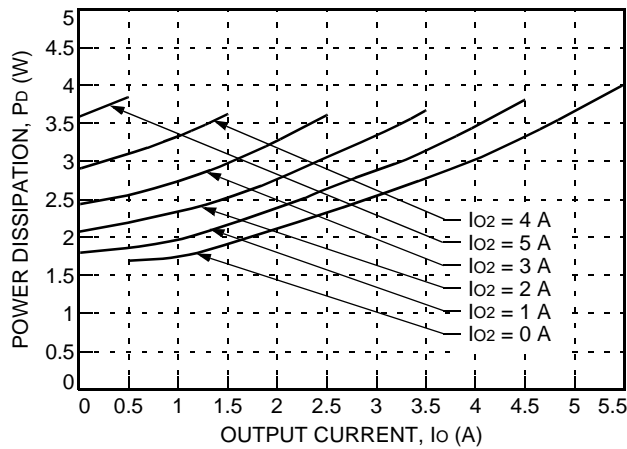

8-3296 (F)

**Figure 31. HW025FG Power Dissipation vs. Output Current at  $V_i = 36\text{ V}$**

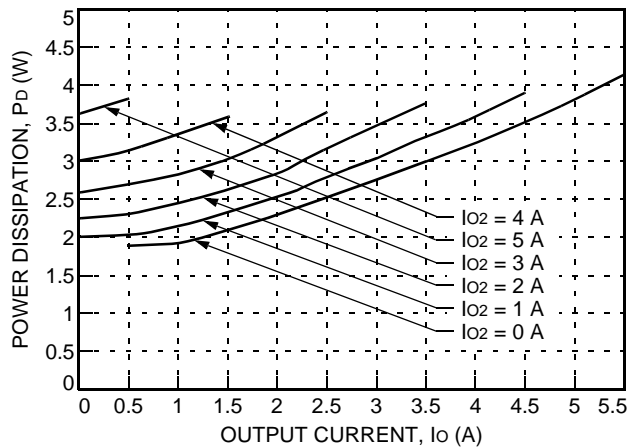

8-3297 (F)

**Figure 32. HW025FG Power Dissipation vs. Output Current at  $V_i = 48\text{ V}$**

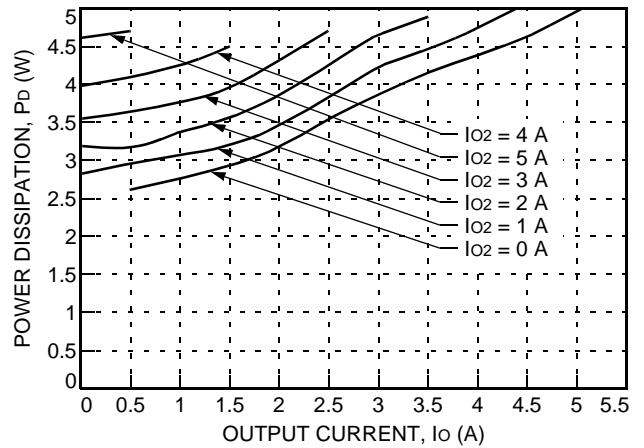

8-3298 (F)

**Figure 33. HW025FG Power Dissipation vs. Output Current at  $V_i = 75\text{ V}$**

**EMC Considerations**

Figure 34 shows the suggested configuration to meet conducted limits of EN55022 Class B.

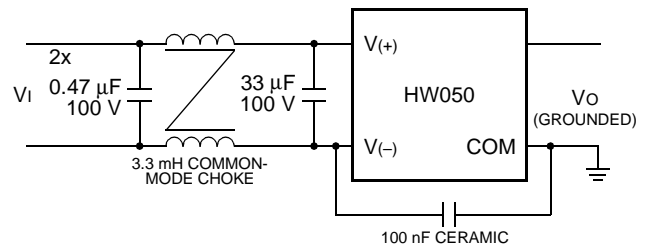

8-2684 (F)

**Figure 34. Suggested Configuration for EN55022**

For assistance with designing for EMC compliance, please refer to the FLTR100V10 data sheet (DS99-294EPS).

**Layout Considerations**

Copper paths must not be routed beneath the power module mounting inserts. For additional layout guidelines, refer to FLTR100V10 data sheet (DS99-294EPS).

## Outline Diagram

Dimensions are in millimeters and (inches).

Tolerances: x.x mm ± 0.5 mm (x.xx in. ± 0.02 in.)  
 x.xx mm ± 0.25 mm (x.xxx in. ± 0.010 in.)

### Top View

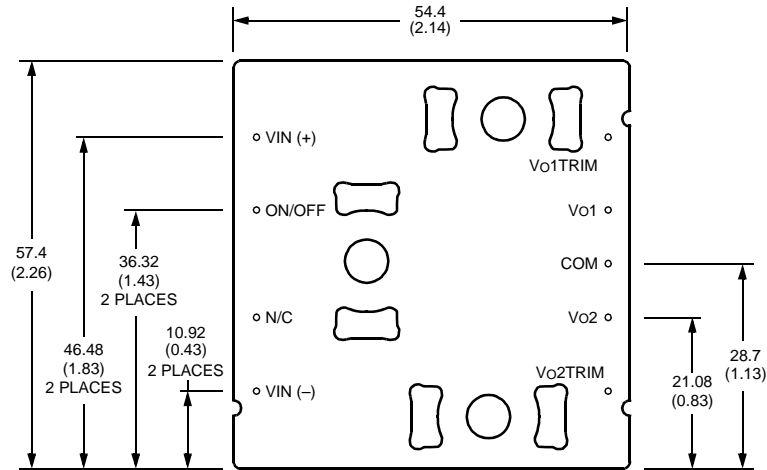

### Side View

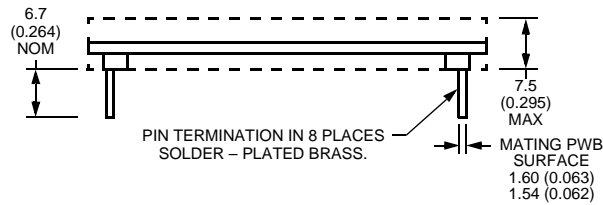

### Bottom View

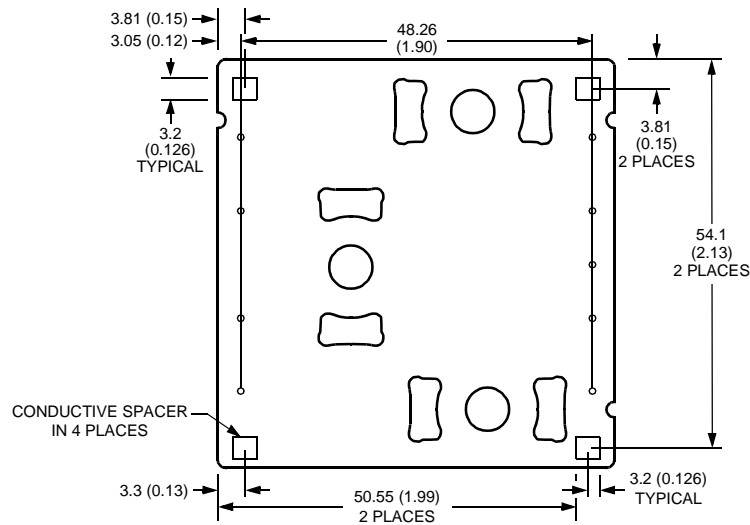

8-3196 (F)



## Recommended Hole Pattern

Top-side footprint.

Dimensions are in millimeters and (inches).

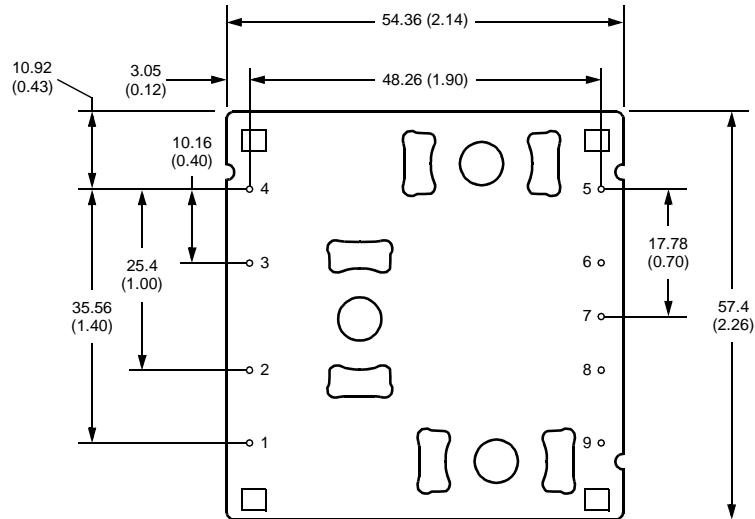

8-3196 (F)

**Table 4. Pin Functions**

Pin	Function	Pin	Function
1	Vi(+)	6	Vo2
2	REMOTE ON/OFF	7	COM
3	Not Connected	8	Vo1
4	Vi(-)	9	Vo1TRIM
5	Vo2TRIM		

## Ordering Information

Please contact your Tyco Electronics' Account Manager or Field Application Engineer for pricing and availability.

**Table 5. Device Codes**

Input Voltage	Output Voltage	Output Current	Remote On/Off Logic	Device Code	Comcode
48 V	5.0 V	2.5 A		HW025AF	108776774
48 V	3.3 V	2.5 A			
48 V	3.3 V	2.5 A		HW025FG	108573023
48 V	2.5 V	2.5 A			

## **Notes**

## **Notes**



**Tyco Electronics Power Systems, Inc.**

3000 Skyline Drive, Mesquite, TX 75149, USA  
**+1-800-526-7819** FAX: +1-888-315-5182  
(Outside U.S.A.: **+1-972-284-2626**, FAX: +1-972-284-2900)  
<http://power.tycoelectronics.com>

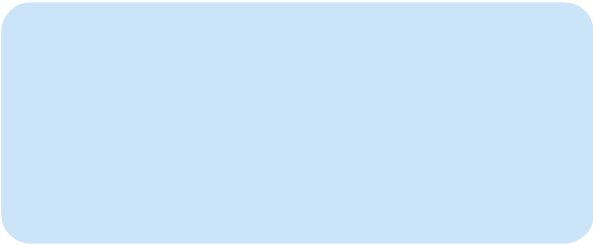

---

Tyco Electronics Corporation reserves the right to make changes to the product(s) or information contained herein without notice. No liability is assumed as a result of their use or application. No rights under any patent accompany the sale of any such product(s) or information.

© 2001 Tyco Electronics Corporation, Harrisburg, PA. All International Rights Reserved.  
Printed in U.S.A.

August 2000  
DS99-344EPS (Replaces PB00-007EPS)

