



AN1484 APPLICATION NOTE

A 3.6 WATTS TRAVEL ADAPTOR USING VIPer12A

G. Augustoni - F. Salanitri

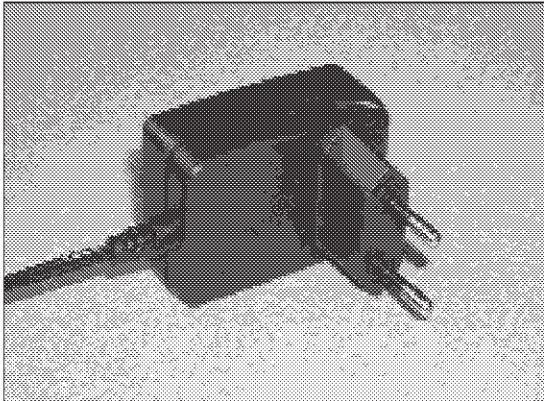

Table 1: System Performances

Parameters	100VDC	380VDC
Standby Power	90mW	119mW
Efficiency at 3.6W	62%	66%
Short Circuit Power	1W	1.3W
Load Regulation	3%	2%

Abstract

The VIPer12A is an integrated PWM and MOSFET circuit for low power application in the 5W range, typically in Cellular Phone Adapters. It is housed in surface mount SO-8 and DIP8 packages.

With the availability of VIPer12A in SO-8 package and the limited number of external components for a real PWM operation, building a compact and performant power supply becomes simple.

The travel adaptor design presented here, has been made with the aim of minimising overall cost for a secondary voltage and current regulated adapter, topology widely used in Cellular Phone Adapters.

The VIPer12A presents itself as the answer for lower consumption in standby, like in home appliances where it will be required to limit non negligible "off the use" consumptions, as recommended by the "European Commission of Energy". Today regulations demand less than 1 Watt. Thanks to VIPer12A low power consumption, it is possible to achieve 100mW standby power in a wide range of operations.

1.0 PRINCIPLE OF OPERATION

The circuit is a standard Flyback converter with secondary current and voltage regulation driving the VIPer12A feedback pin through an optocoupler.

1.1 The VIPer12A

1.1.1 Start-up phase

VIPer12A, as any member of the VIPer family, has an integrated high voltage current source to charge C3 Vdd capacitor until it reaches its startup level (15V). When Vdd gets to 15V, the VIPer switches, supplied by the energy stored in C3, until it is supplied through the auxiliary winding.

1.1.2 Auxiliary Supply

VIPer12A has a wide operating voltage range from 9V to 40V, respectively maximum and minimum values for undervoltage and overvoltage protections. This wide voltage supply range simplifies the design of the VIPer12A supply but, to ensure proper operation of the application in any case, it is advised:

- in normal operation, to supply VIPer12A within its operating range;
- in standby mode, to minimize auxiliary consumption to achieve very low standby power;
- in short circuit, to limit output power by going into an hiccup mode;
- in constant current mode, to ensure current regulation below 2V before going into hiccup mode.

AN1484 - APPLICATION NOTE

1.1.3 Burst Mode

The VIPer12A integrates a current mode PWM with a Power MOSFET and includes the leading edge blanking function. The burst mode is a feature which allows VIPer12A to reduce its average switching frequency when the energy drained by the output load goes below $E=(t_b \cdot V_{in})^2 \cdot f_{sw} / 2L_p$ (t_b Blanking time, V_{in} DC input voltage, f_{sw} Switching frequency, L_p Primary Inductance). This is obtained with a small ripple current around shut down current of feedback pin and maintaining the V_{dd} voltage above 9V. If V_{dd} goes below 9V there is the "bad burst mode" in which VIPer12A repeats the restart cycle continuously, with a worst standby consumption and a higher secondary ripple voltage.

1.1.4 Compensation and Duty cycle control

The internal structure of VIPer12A feedback and compensation pin (FB pin 3) is shown in Figure 1. The current injected on the FB pin is added to the one coming from the SenseFet in R2 and then compared to an internal 0.23V V_{ref} . When FB voltage is closed to ground, the VIPer12A delivers its full power. On the other side, when FB voltage is above $0.23 \cdot (R1+R2)/R2$, the VIPer12A stops switching.

The FB pin is directly driven by the emitter of the optocoupler, behaving as a current source. This current is filtered by a small 47nF capacitor C5 to guarantee cycle to cycle stability.

Important: It is necessary to keep C5 very close to the VIPer12A feedback pin to avoid high frequency instability on the compensation loop.

1.1.5 Primary drive

In a flyback power supply, the transformer is used as an energy tank fuelled during the ON time of the Mosfet. When the Mosfet turns off, its drain voltage rises from low value to the Input Voltage + Reflected Voltage when the secondary diode conducts, regaining on the secondary the magnetic energy stored in the transformer. As primary and secondary windings are not perfectly magnetically coupled, there is a serial leakage inductance that behaves like an open inductor charged at I_{peak} that makes the Mosfet drain voltage reach higher values.

If the peak voltage is higher than the V_{dss} of the VIPer12A Mosfet, the device will be destroyed. So the drain voltage must be kept below its avalanche voltage of 730V.

Commonly a clamper based on a RCD network or a diode with a transil to clamp the rise of the drain voltage is used.

The presence of the clamper is an extra consumption in standby mode, especially with RCD clamper respect to the transil clamper. Because the power consumption is manageable with transil clamper, this solution has been chosen here.

Figure 1: VIPer12A Internal Structure

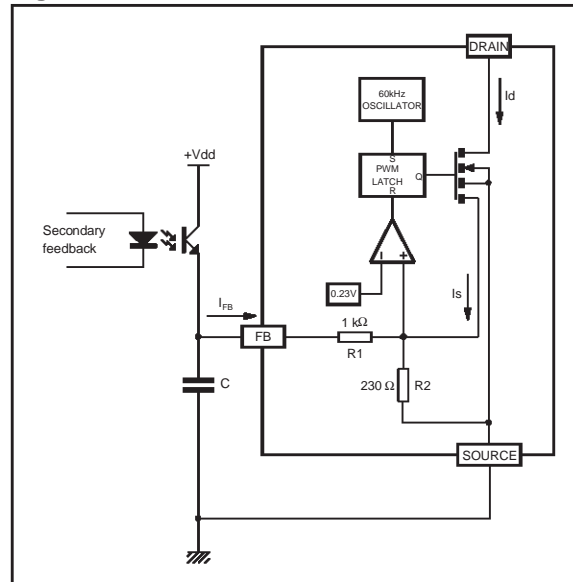

1.2 Secondary Regulation

1.2.1 Voltage Regulation

The Voltage regulation is achieved with a zener diode D6 directly driving the optocoupler. The resistor R3 limits the current in both the zener and the opto in case of overvoltage.

The VIPer12A feedback pin is current controlled and its requirement goes from few uA at full load to 1mA in standby. The same current change is experimented by the regulating zener on the secondary side of the converter leading to around 5% load regulation.

It is possible to improve the load regulation, by connecting a resistor between the zener and the V_{out} . Of course, this will degrade the standby power consumption.

1.2.2 Current Regulation

The current regulation uses the drop voltage across a shunt resistor R6/R7/R8 to bias the T1 transistor base-emitter junction. The T1 collector drives the optocoupler limiting the output power.

Figure 2: Application Schematic

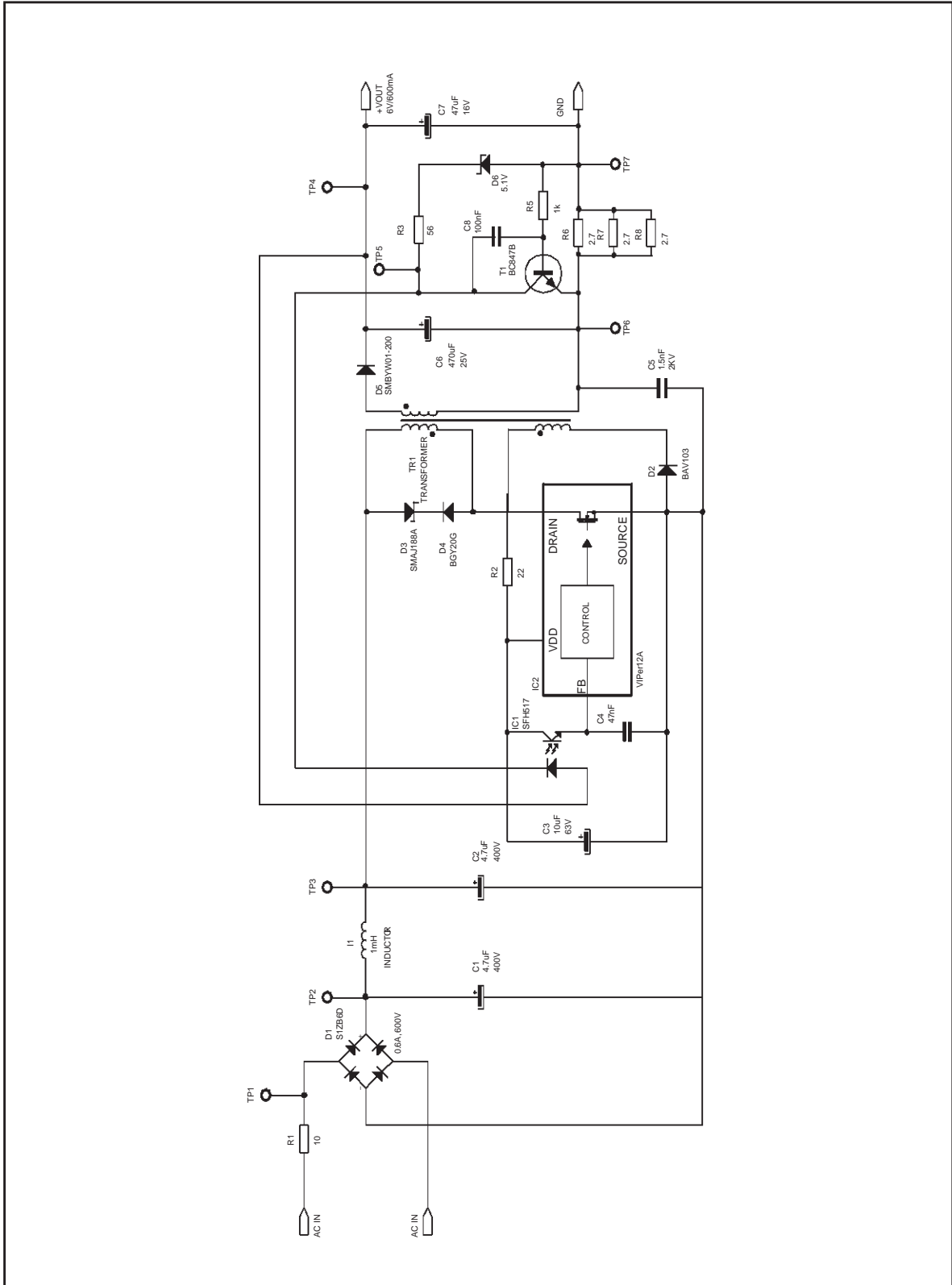

AN1484 - APPLICATION NOTE

The accuracy of this circuit is limited especially in temperature but is unrivalled in terms of cost. The addition of R5 base resistor is necessary in short circuit to avoid destroying T1 Base-Emitter junction. R3 is also necessary in short circuit otherwise T1 collector current directly flows through D6 and the optocoupler is not driven anymore, leading to an increase of short circuit power consumption. C8 limits the gain in frequency of T1, stabilising the loop.

2.0 THE TRANSFORMER

An important part of a SMPS design lies in the transformer. Its performances are a key to the system performances.

The requirements for this application are: small size and limited voltage on the drain.

Table 2: Transformer Target Specification

Parameters	Value
Power	5W
Saturation Current	> 400mA
Primary Inductance	2.5mH
Reflected Voltage	50V
Leakage Inductance	< 100µH or <3%
Primary Capacitance	> 20pF

2.1 Primary inductance

A simple calculation gives the range of values of primary inductance suitable for this application.

VIper12A has a drain current limitation of 360mA min. The energy transferred is $E=1/2LpI_p^2 \cdot f_{sw}$ in discontinuous mode. $E_{min}=5W$, $I_p=360mA$ and $f_{sw}=50kHz$ giving $L_p > 1.54mH$.

The transition mode is when $T_{on} \cdot V_{in} = T_{off} \cdot V_r$ ($T_{on} \cdot V_{in} = L_p \cdot I_p$). The expression of L_p is:

$$L_p = 1/2 \cdot (T_{on} \cdot V_{in})^2 \cdot f_{sw} / E$$

With $V_{in}=150V$, $V_r=50V$, $T_{on}=5\mu s$, $E=5W$ give $L_p=2.8mH$.

V_{in} was chosen to reach the continuous mode at low input voltage level. V_r is low to limit the drain peak voltage.

The transformer optimisation has led to a final value of 2.5mH partly to reduce the primary turns and their power dissipation with an E12.5 bobbin.

2.2 Transformer Structure

A standard transformer structure (so called with windings order Primary/Auxiliary/Secondary) gives the following results on VIper12A supply:

Table 3: VIper12A V_{dd} with a Standard Transformer

Conditions	100VDC	380VDC
Stand-by	10V	8V
Load 6V/100mA	15V	15V
Load 6V/600mA	25V	26V
Short Circuit	9V	10V

Two concerns can be seen from this table:

- the VIper12A is not going in hiccup mode in Short Circuit

- The supply voltage is too low in Standby with the risk of a "Bad burst mode" with higher standby consumption and poor regulation (VIper12A undervoltage is at 9V max with 8V Typical).

The solution, implemented in the demoboard, is the optimized structure (so called with windings order: Primary/Secondary/Auxiliary) shown on figure 3.

Figure 3: Transformer Structure

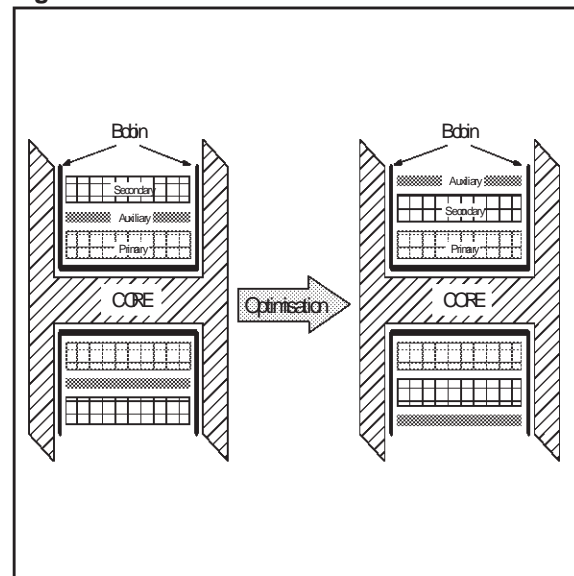

The position of the auxiliary winding on top gives the following benefits:

- better coupling of primary and secondary windings thus lower leakage inductance and energy stored in the ringing circuit
- no coupling between primary / secondary leakage inductance and auxiliary windings
- less capacitive coupling between primary and auxiliary windings

Figure 4a and Figure 4b show the drain voltage of the VIPer12 (Trace 1) and Vdd voltage before R2 (Trace 2) at full load and in short circuit with the auxiliary in sandwich (1) and on top (2) of the windings.

Figure 4a₁: At full Load at 100V (Sandwich)

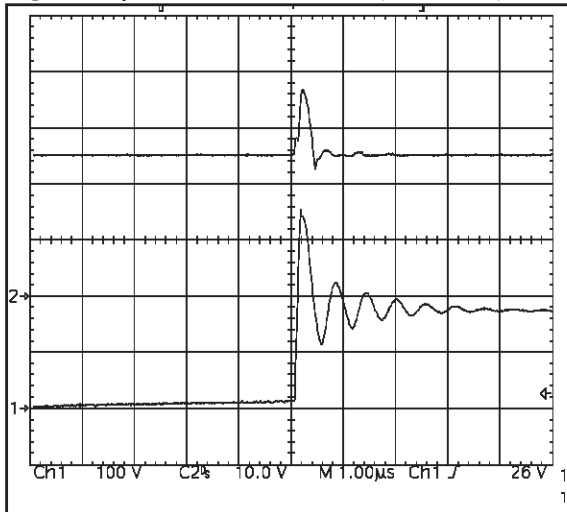

Figure 4a₂: At full Load at 100V (On Top)

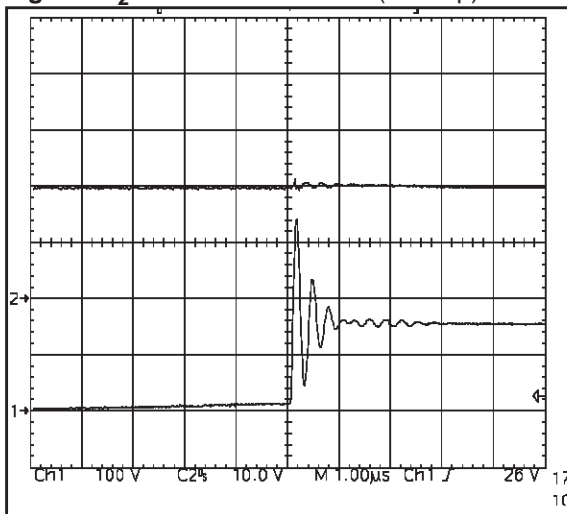

Figure 4b₁: In Short Circuit at 100V (Sandwich)

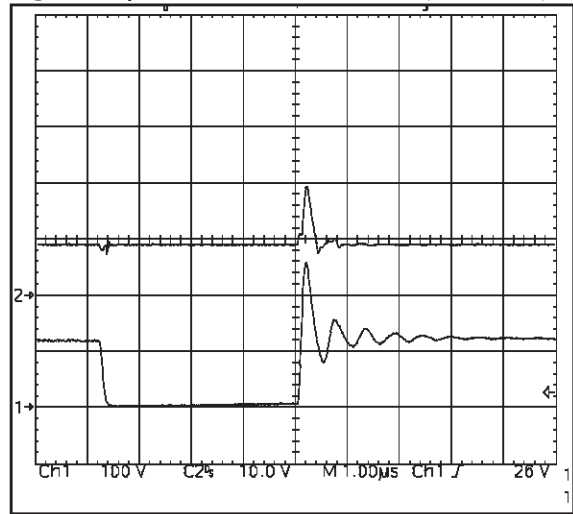
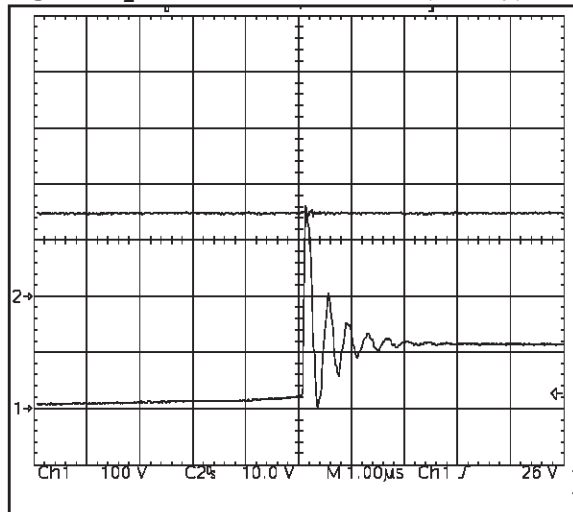

Figure 4b₂: In Short Circuit at 100V (On Top)



The VIPer12A auxiliary supply shows the following voltage on Vdd pin:

Table 4: VIPer12A Vdd with an optimized transformer

Conditions	100V	380V
Standby	12V	11V
Load 6V/100mA	18V	18V
Load 6V/600mA	20V	19.5V
Short Circuit	Hiccup	Hiccup

AN1484 - APPLICATION NOTE

In these conditions, the VIPer12A is properly operating. It draws less than 100mW in standby and the Hiccup mode is safe in short circuit (Figure 5a and Figure 5b).

Figure 5a: Hiccup Mode at 100V

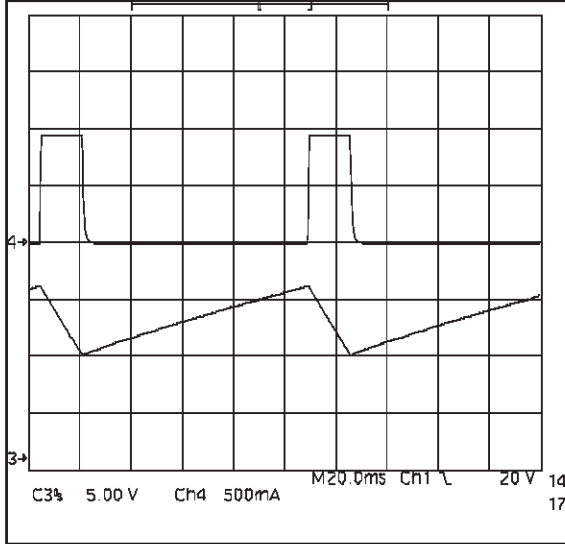
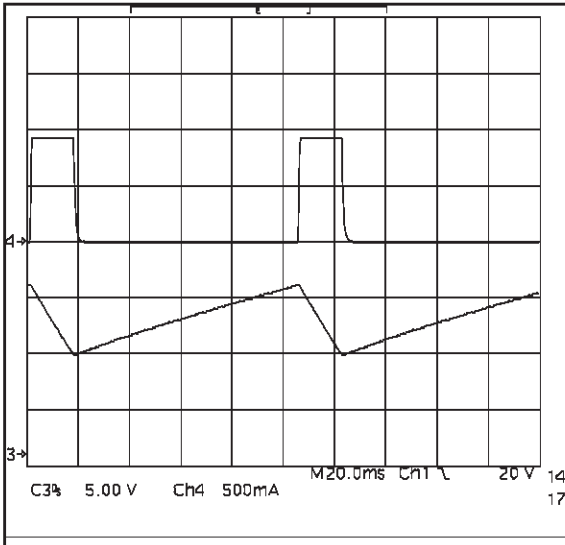

Figure 5b: Hiccup Mode at 380V



2.3 Peak Drain Voltage

This transformer allows the reduction of Drain peak voltage in any condition.

The gain of this structure is 70V. With the lower reflected voltage (100V to 50V), the gain is up to 120V. There is a good voltage margin at full load under 380VDC. This means that a standard 200V

transil clamber will not take any energy in normal operation.

The clamber is still necessary during start-up and short circuit, the drain voltage goes above the 730V VIPer12A avalanche voltage.

Table 5: MOSFET Peak Voltage at 380VDC

Conditions	Standard Transfo	Optimized Transfo
Full Load V _{peak}	750V	630V
Reflected Voltage	100V	50V
Leakage Inductance	105μH	25μH
Primary Capacitance	22pF	26pF
Primary Inductance	3mH	2.6mH
Full Load I _{peak}	260mA	275mA

2.4 EMC Compatibility

Most of the EMC performances are due to the "floating" voltage of the secondary winding or to the voltage across C7 EMC capacitor. This "floating" amplitude is linked to all the parasitic capacitances along the wire between primary and secondary windings. With the optimized transformer, the EMC performances are degraded. But it is possible to turn this problem into an advantage.

The secondary winding is placed between the primary and the auxiliary ones. The auxiliary winding is used to compensate the induction from primary to the secondary. Figure 6 shows this compensation.

Figure 6: EMC Compensation Technique

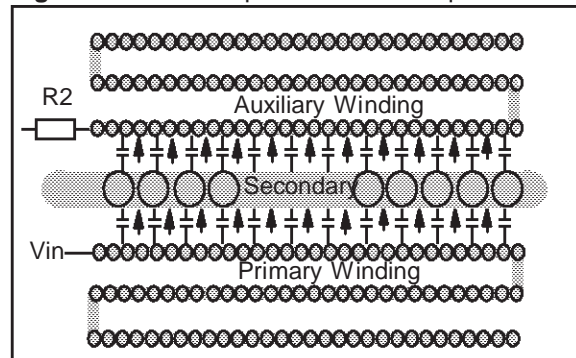

- The cold point is wound close to the secondary winding, limiting the voltage swing of the closest one.

- The voltage variation of the primary and the auxiliary side of the converter must be opposite. In this design, the D3 diode has been placed on the ground so the voltage swing is opposite on the transition.

2.5 Transformer Specification

- Lp = 2.5mH @ 50KHz
- Li = 30µH @ 50KHz
- Cp = 35pF @ 1MHz
- Voltages: 55V-Pri / 7.2V-Sec. / 20.0V-Aux
- Isat > 400mA
- Pout = 5W
- Geometry: E12.5
- Winding Order: Primary / Secondary / Auxiliary
- Primary Winding: 180 Turns AWG 38
- Auxiliary Winding: 66 Turns AWG 38
- Secondary Winding: 25 Triple isolation 0.20mm

3.0 SYSTEM PERFORMANCES

3.1 Efficiency

The Power losses are distributed at 6V / 600mA output power as follows:

- 400mW in the output diode
- 700mW in the VIPer12A
- 300mW in the transformer
- 380mW in the shunt resistor

Overall efficiency is 3.6W / (3.6W + 1.78W) = 67%.

If the losses in the shunt resistor are considered as available power, the converter efficiency becomes 3.98W / (3.98W + 1.4W) = 74%. This is possible using secondary controller like STM's TSM101.

Figure 7a: Efficiency at 100V

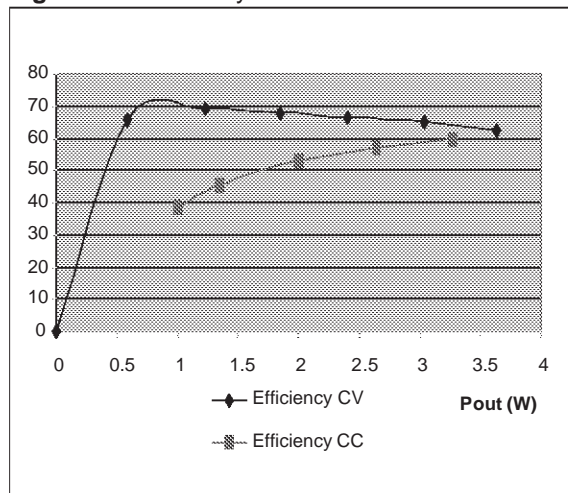
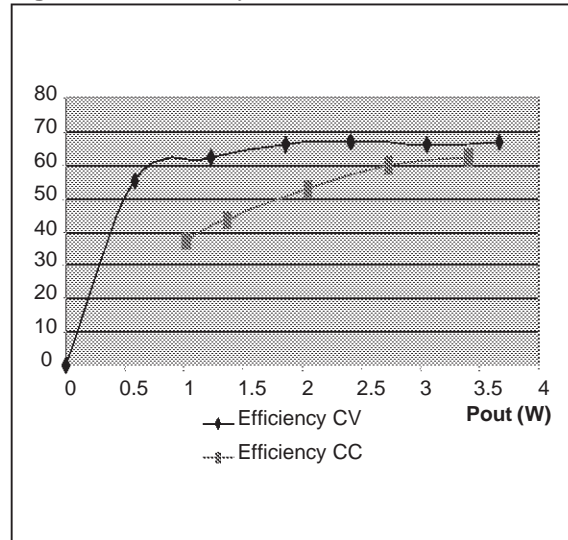
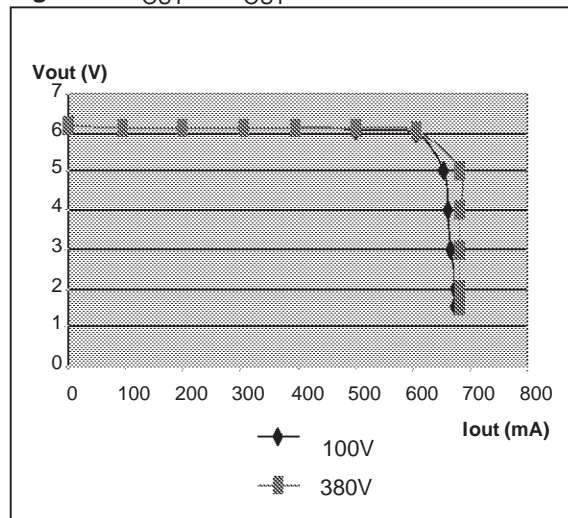

Figure 7b: Efficiency at 380V



3.2 Regulation

Figure 8: V_{OUT} Vs. I_{OUT}



3.3 Standby Consumption

The demoboard consumes less than 100mW at 100VDC and 120mW at 380VDC. This power level is far below today regulation's requirement.

The charts in Figure 9a/9b shows the details of the charger standby consumption at minimum and maximum input voltage.

The major contribution to the standby consumption is the VIPer12A own consumption of just 35mW and is independent from input voltage.

AN1484 - APPLICATION NOTE

Figure 9a: Standby Consumption at 100V

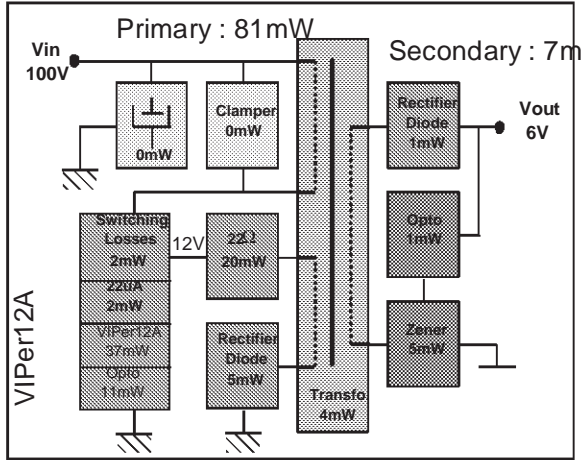
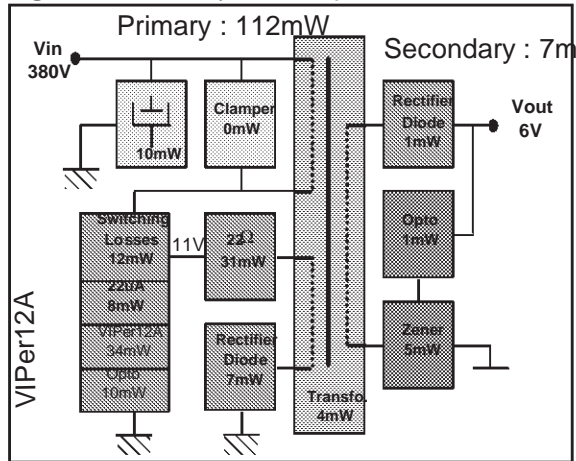

Figure 9b: Standby Consumption at 380V



The only change is due to the internal startup current source of 22 μ A which consumption goes from 2mW at 100V up to 8mW at 380V. Another factor due to the VIPer12A is the current used on the feedback pin, regulated around 1mA in standby that leads to a 10mW consumption in the primary and 6mW in the secondary (with an opto gain of 1). Note that it is necessary to keep a certain level of current in the regulating zener to improve the load regulation. As load increases, the current in the opto and the zener decreases lowering the output regulated voltage. Overall, VIPer12A needs 50mW to operate in standby.

It is possible to spare some mW in the auxiliary supply, especially the 22 Ω serial resistor which is necessary to regulate the transformer ringing voltage peak. In the demoboard the transformer voltage has a narrow dynamic so R2 becomes useless. So the standby consumption is decreased

if the resistor is removed and the transformer is tuned to set 10V or less on VIPer12A Vdd.

The standby consumption is less than 60mW at 100V and 80mW at 380V: fairly good considering the 50mW required by VIPer12A.

4.0 DESIGN MATERIAL

4.1 PCB Solder Side

Figure 10a: Bottom view of Charger's Board.

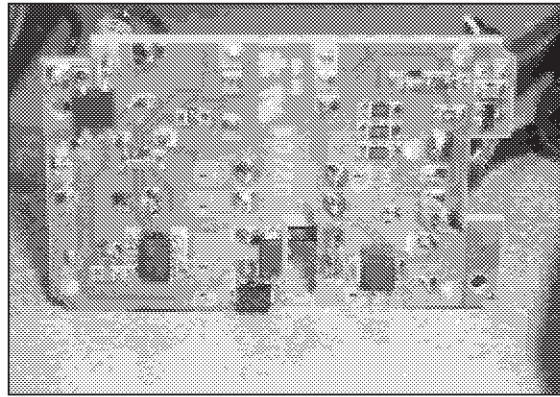
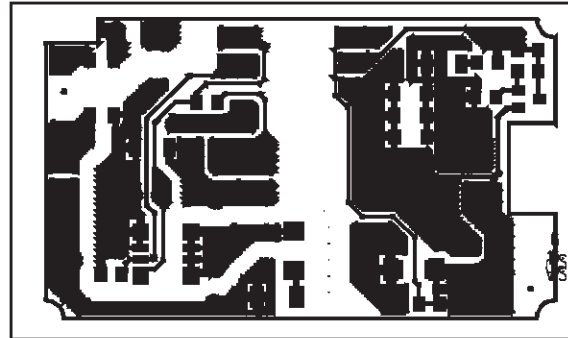
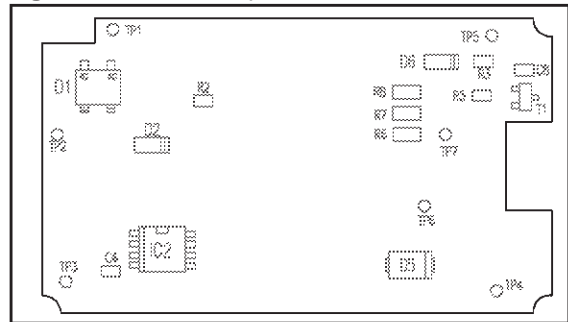

Figure 10b: PCB Art Work



4.2 Silk Screen Solder Side

Figure 11: SMD components



4.3 Silk Screen Component Side

Figure 11a: Top view of the Charger's Board

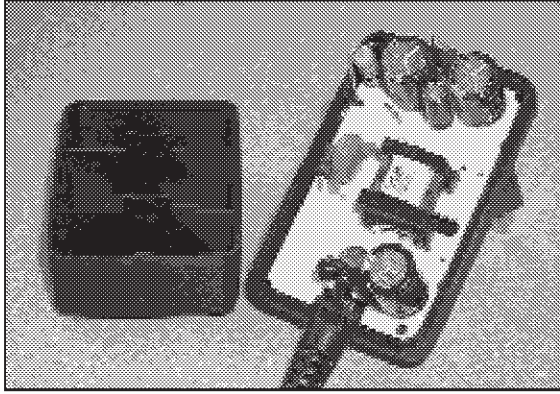
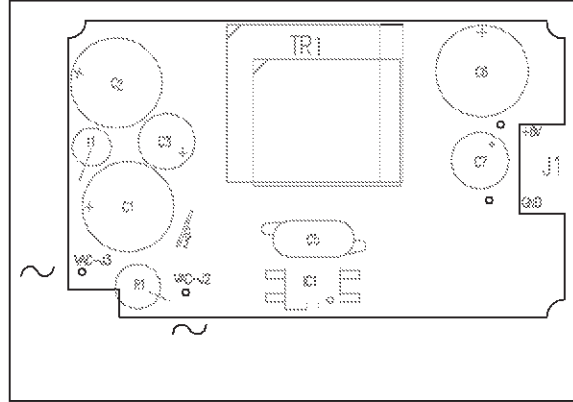

Figure 11b: Through Hole Components



AN1484 - APPLICATION NOTE

4.4 Component List

Ref.	Part List Description	Supplier
R1	Wirewound Res. 10ohm 5% 2W	VITROHM TYOHM
R2	Chip Res. 22ohm 5% 0.125W S0805	
R3	Chip Res. 56ohm 5% 0.125W S0805	
R5	Chip Res. 1Kohm 1% 0.125W S0805	
R6-R7-R8	Chip Res. 2.7ohm 5% 0.25W S1206	
C8	Chip Cap. 100nF 25V X7R S0805	
C4	Chip Cap. 47nF 50V X7R S0805	
C5	Chip Cap. 1.5nF KX CD WKP	MURATA TDK ROEDERSTEIN
C1-C2	Elect. Cap. 4.7uF 400V 10x12.5 SD VZ KMG P/N 2222 151 90021 NHG	SAMWHA NICHICON/SANYO NIPPON CHEMI-CON PHILIPS PANASONIC
C3	Elect. Cap. 10uF 63V 5x11 LXZ YXG FC PW WD/WL	NIPPON CHEMI-CON RUBICON PANASONIC NICHICON SAMWHA
C6	Elect. Cap. 470uF 25V 10x16	
C7	Elect. Cap. 47uF 16V 6.3x7	
D1	Phase Bridge Rectifier S1ZB60 MB6S	SHINDENGEN G.I.
D2	Diode BAV103 MINIMELF	
D5	Diode SMBY01-200 SMA	STMicroelectronics
D6	Diode Zener 5.1V 2% MINIMELF	
I1	Inductor 1mH series SPS	TDK
IC1	Optocoupler SFH617-A3 PS2561L-1D PC123FY/2 TCET1106G	SIEMENS NEC SHARP TEMIC
IC2	I.C. VIPer12A	STMicroelectronics
T1	BC847B SOT23	
TR1	Transformer PF0037	PULSE
JP1	Jumper Tinned Copper Wire 0.7	

Information furnished is believed to be accurate and reliable. However, STMicroelectronics assumes no responsibility for the consequences of use of such information nor for any infringement of patents or other rights of third parties which may result from its use. No license is granted by implication or otherwise under any patent or patent rights of STMicroelectronics. Specifications mentioned in this publication are subject to change without notice. This publication supersedes and replaces all information previously supplied. STMicroelectronics products are not authorized for use as critical components in life support devices or systems without express written approval of STMicroelectronics. The ST logo is a trademark of STMicroelectronics

© 2002 STMicroelectronics - Printed in ITALY- All Rights Reserved.

STMicroelectronics GROUP OF COMPANIES

Australia - Brazil - Canada - China - Finland - France - Germany - Hong Kong - India - Israel - Italy - Japan - Malaysia -
Malta - Morocco - Singapore - Spain - Sweden - Switzerland - United Kingdom - U.S.A.

<http://www.st.com>