

Micropower Precision Shunt Voltage Reference

FEATURES

- Initial Voltage Accuracy: 0.05%
- Low Operating Current: 10 μ A
- Low Drift: 10ppm/ $^{\circ}$ C Max
- Less Than 1 Ω Dynamic Impedance
- Available in 1.25V, 2.5V, 4.096V and 5V in SO-8 and TO-92 Packages
- 1.25V and 2.5V Available in MSOP Package
- Both Commercial and Industrial Temperature Range Parts Are Available

APPLICATIONS

- Portable Meters
- Precision Regulators
- A/D and D/A Converters
- Calibrators

DESCRIPTION

The LT[®]1634 is a micropower, precision, shunt voltage reference. The bandgap reference uses trimmed precision thin film resistors to achieve 0.05% initial voltage accuracy. Improved curvature correction technique guarantees 10ppm/ $^{\circ}$ C maximum temperature drift. Advances in design, processing and packaging techniques guarantee 10 μ A operation and low temperature cycling hysteresis. The LT1634 does not require an output compensation capacitor, but is stable with capacitive loads. Low dynamic impedance makes the LT1634 reference easy to use from unregulated supplies.

The LT1634 reference can be used as a high performance upgrade to the LM185/LM385, LT1004 and LT1034 where lower power and guaranteed temperature drift is required.

 LTC and LT are registered trademarks of Linear Technology Corporation.

TYPICAL APPLICATION

Super Accurate $\pm 4.096V$ Output References

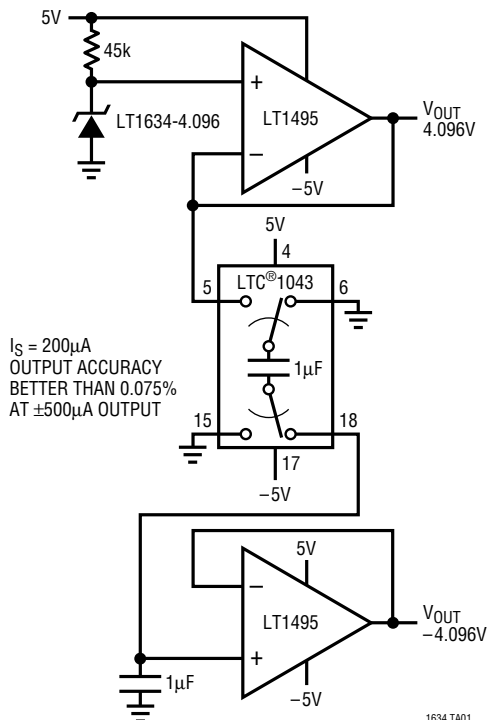

Temperature Drift

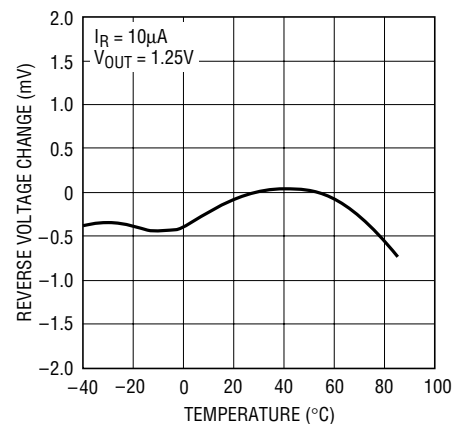

1634 TA02

ABSOLUTE MAXIMUM RATINGS

Operating Current

1.25V	100mA
2.5V	50mA
4.096V, 5V	30mA
Forward Current	20mA

Operating Temperature Range

Commercial	0°C to 70°C
Industrial	-40°C to 85°C
Storage Temperature Range (Note 1) ...	-65°C to 150°C
Lead Temperature (Soldering, 10 sec)	300°C

PACKAGE/ORDER INFORMATION

<p>MS8 PACKAGE 8-LEAD PLASTIC MSOP T_{JMAX} = 125°C, θ_{JA} = 250°C/W</p>		<p>S8 PACKAGE 8-LEAD PLASTIC SO T_{JMAX} = 125°C, θ_{JA} = 190°C/W</p>	
ORDER PART NUMBER	MS8 PART MARKING	ORDER PART NUMBER	S8 PART MARKING
LT1634BCMS8-1.25 LT1634BCMS8-2.5	LTCV LTDF	LT1634ACS8-1.25 LT1634ACS8-2.5 LT1634ACS8-4.096 LT1634ACS8-5 LT1634AIS8-1.25 LT1634AIS8-2.5 LT1634AIS8-4.096 LT1634AIS8-5 LT1634BCS8-1.25 LT1634BCS8-2.5 LT1634BCS8-4.096 LT1634BCS8-5 LT1634BIS8-1.25 LT1634BIS8-2.5 LT1634BIS8-4.096 LT1634BIS8-5	634A1 634A2 634A4 634A5 634AI1 634AI2 634AI4 634AI5 634B1 634B2 634B4 634B5 634BI1 634BI2 634BI4 634BI5
<p>Z PACKAGE 3-LEAD PLASTIC TO-92 T_{JMAX} = 125°C, θ_{JA} = 190°C/W</p>		ORDER PART NUMBER	
		LT1634CCZ-1.25 LT1634CCZ-2.5 LT1634CCZ-4.096 LT1634CCZ-5	

*Connected internally. Do Not Connect external circuitry to these pins.

**Connect to ground in user application.

Consult factory for Military grade parts.

AVAILABLE OPTIONS

TEMPERATURE	ACCURACY (%)	TEMPERATURE COEFFICIENT (ppm/°C)	PACKAGE TYPE		
			MS8	S8	Z
0°C to 70°C	0.05	10		LT1634ACS8-1.25 LT1634ACS8-2.5 LT1634ACS8-4.096 LT1634ACS8-5	
-40°C to 85°C	0.05	10		LT1634AIS8-1.25 LT1634AIS8-2.5 LT1634AIS8-4.096 LT1634AIS8-5	
0°C to 70°C	0.05	25	LT1634BCMS8-1.25 LT1634BCMS8-2.5	LT1634BCS8-1.25 LT1634BCS8-2.5 LT1634BCS8-4.096 LT1634BCS8-5	
-40°C to 85°C	0.05	25		LT1634BIS8-1.25 LT1634BIS8-2.5 LT1634BIS8-4.096 LT1634BIS8-5	
0°C to 70°C	0.20	25			LT1634CCZ-1.25 LT1634CCZ-2.5 LT1634CCZ-4.096 LT1634CCZ-5

1.25V ELECTRICAL CHARACTERISTICS (Note 2)

PARAMETER	CONDITIONS	MIN	TYP	MAX	UNITS
Reverse Breakdown Voltage	LT1634ACS8/LT1634BCMS8/LT1634BCS8/ LT1634AIS8/LT1634BIS8 ($I_R = 10\mu A$)	1.24937 -0.05	1.250	1.25062 0.05	V %
	LT1634CCZ ($I_R = 10\mu A$)	1.24750 -0.20	1.250	1.25250 0.20	V %
	LT1634ACS8 ($I_R = 10\mu A$)	● 1.24849 -0.12	1.250	1.25149 0.12	V %
	LT1634AIS8 ($I_R = 10\mu A$)	● 1.24781 -0.175	1.250	1.25218 0.175	V %
	LT1634BCS8/LT1634BCMS8 ($I_R = 10\mu A$)	● 1.24718 -0.225	1.250	1.25281 0.225	V %
	LT1634BIS8 ($I_R = 10\mu A$)	● 1.24547 -0.362	1.250	1.25453 0.362	V %
	LT1634CCZ ($I_R = 10\mu A$)	● 1.24531 -0.375	1.250	1.25469 0.375	V %
Reverse Breakdown Change with Current (Note 3)	$10\mu A \leq I_R \leq 2mA$	●	0.25 0.30	1 2	mV mV
	$2mA \leq I_R \leq 20mA$	●	2 2	8 10	mV mV
Minimum Operating Current		●		7	μA
Temperature Coefficient	LT1634A, $I_R = 10\mu A$	●	4	10	ppm/°C
	LT1634B, $I_R = 10\mu A$	●	10	25	ppm/°C
Reverse Dynamic Impedance (Note 4)	$10\mu A \leq I_R \leq 2mA$	●	0.125 0.150	0.5 1.0	Ω Ω
Low Frequency Noise (Note 5)	$I_R = 10\mu A, 0.1Hz \leq f \leq 10Hz$		10		μV_{P-P}
Hysteresis (Note 6)	$\Delta T = -40^\circ C$ to $85^\circ C$		160		ppm
	$\Delta T = 0^\circ C$ to $70^\circ C$		40		ppm

2.5V ELECTRICAL CHARACTERISTICS (Note 2)

PARAMETER	CONDITIONS	MIN	TYP	MAX	UNITS
Reverse Breakdown Voltage	LT1634ACS8/LT1634BCMS8/LT1634BCS8/ LT1634AIS8/LT1634BIS8 ($I_R = 10\mu A$)	2.49875 -0.05	2.500	2.50125 0.05	V %
	LT1634CCZ ($I_R = 10\mu A$)	2.49500 -0.20	2.500	2.50500 0.20	V %
	LT1634ACS8 ($I_R = 10\mu A$)	● 2.49700 -0.12	2.500	2.50300 0.12	V %
	LT1634AIS8 ($I_R = 10\mu A$)	● 2.49562 -0.175	2.500	2.50437 0.175	V %
	LT1634BCMS8/LT1634BCS8 ($I_R = 10\mu A$)	● 2.49437 -0.225	2.500	2.50562 0.225	V %
	LT1634BIS8 ($I_R = 10\mu A$)	● 2.49094 -0.362	2.500	2.50906 0.362	V %
	LT1634CCZ ($I_R = 10\mu A$)	● 2.49062 -0.375	2.500	2.50937 0.375	V %
Reverse Breakdown Change with Current (Note 3)	$10\mu A \leq I_R \leq 2mA$	●	0.30 0.40	1.5 3.0	mV mV
	$2mA \leq I_R \leq 20mA$	●	2 2	8 10	mV mV
Minimum Operating Current		●		8	μA
Temperature Coefficient	LT1634A, $I_R = 10\mu A$	●	4	10	ppm/ $^{\circ}C$
	LT1634B, $I_R = 10\mu A$	●	10	25	ppm/ $^{\circ}C$
Reverse Dynamic Impedance (Note 4)	$10\mu A \leq I_R \leq 2mA$	●	0.15 0.20	0.75 1.50	Ω Ω
Low Frequency Noise (Note 5)	$I_R = 10\mu A$, $0.1Hz \leq f \leq 10Hz$		15		μV_{P-P}
Hysteresis (Note 6)	$\Delta T = -40^{\circ}C$ to $85^{\circ}C$		160		ppm
	$\Delta T = 0^{\circ}C$ to $70^{\circ}C$		40		ppm

4.096V ELECTRICAL CHARACTERISTICS (Note 2)

PARAMETER	CONDITIONS	MIN	TYP	MAX	UNITS
Reverse Breakdown Voltage	LT1634ACS8/LT1634BCS8/ LT1634AIS8/LT1634BIS8 ($I_R = 20\mu A$)	4.09395 -0.05	4.096	4.09805 0.05	V %
	LT1634CCZ ($I_R = 20\mu A$)	4.08780 -0.20	4.096	4.10419 0.20	V %
	LT1634ACS8 ($I_R = 20\mu A$)	● 4.09108 -0.12	4.096	4.10091 0.12	V %
	LT1634AIS8 ($I_R = 20\mu A$)	● 4.08883 -0.175	4.096	4.10317 0.175	V %
	LT1634BCS8 ($I_R = 20\mu A$)	● 4.08678 -0.225	4.096	4.10522 0.225	V %
	LT1634BIS8 ($I_R = 20\mu A$)	● 4.08115 -0.362	4.096	4.11085 0.362	V %
	LT1634CCZ ($I_R = 20\mu A$)	● 4.08064 -0.375	4.096	4.11137 0.375	V %
Reverse Breakdown Change with Current (Note 3)	$20\mu A \leq I_R \leq 2mA$	●	0.3 0.4	1.5 3.0	mV mV
	$2mA \leq I_R \leq 20mA$	●	2 2	8 10	mV mV
Minimum Operating Current		●		15	μA

4.096V ELECTRICAL CHARACTERISTICS (Note 2)

PARAMETER	CONDITIONS	MIN	TYP	MAX	UNITS
Temperature Coefficient	LT1634A, $I_R = 20\mu\text{A}$	●	4	10	ppm/°C
	LT1634B, $I_R = 20\mu\text{A}$	●	10	25	ppm/°C
Reverse Dynamic Impedance (Note 4)	$20\mu\text{A} \leq I_R \leq 2\text{mA}$	●	0.15	0.75	Ω
			0.20	1.50	Ω
Low Frequency Noise (Note 5)	$I_R = 20\mu\text{A}$, $0.1\text{Hz} \leq f \leq 10\text{Hz}$		30		$\mu\text{V}_{\text{P-P}}$
Hysteresis (Note 6)	$\Delta T = -40^\circ\text{C}$ to 85°C $\Delta T = 0^\circ\text{C}$ to 70°C		160		ppm
			40		ppm

5V ELECTRICAL CHARACTERISTICS (Note 2)

PARAMETER	CONDITIONS	MIN	TYP	MAX	UNITS
Reverse Breakdown Voltage	LT1634ACS8/LT1634BCS8/ LT1634AIS8/LT1634BIS8 ($I_R = 20\mu\text{A}$)	4.99750 -0.05	5.000	5.00250 0.05	V %
	LT1634CCZ ($I_R = 20\mu\text{A}$)	4.99000 -0.20	5.000	5.01000 0.20	V %
	LT1634ACS8 ($I_R = 20\mu\text{A}$)	● 4.99400 -0.12	5.000	5.00600 0.12	V %
	LT1634AIS8 ($I_R = 20\mu\text{A}$)	● 4.99125 -0.175	5.000	5.00875 0.175	V %
	LT1634BCS8 ($I_R = 20\mu\text{A}$)	● 4.98875 -0.225	5.000	5.01125 0.225	V %
	LT1634BIS8 ($I_R = 20\mu\text{A}$)	● 4.98188 -0.362	5.000	5.01813 0.362	V %
	LT1634CCZ ($I_R = 20\mu\text{A}$)	● 4.98126 -0.375	5.000	5.01876 0.375	V %
Reverse Breakdown Change with Current (Note 3)	$20\mu\text{A} \leq I_R \leq 2\text{mA}$	●	0.3 0.4	1.5 3.0	mV mV
	$2\text{mA} \leq I_R \leq 20\text{mA}$	●	2 2	8 10	mV mV
Minimum Operating Current		●		15	μA
Temperature Coefficient	LT1634A, $I_R = 20\mu\text{A}$	●	4	10	ppm/°C
	LT1634B, $I_R = 20\mu\text{A}$	●	10	25	ppm/°C
Reverse Dynamic Impedance (Note 4)	$20\mu\text{A} \leq I_R \leq 2\text{mA}$	●	0.15	0.75	Ω
			0.20	1.50	Ω
Low Frequency Noise (Note 5)	$I_R = 20\mu\text{A}$, $0.1\text{Hz} \leq f \leq 10\text{Hz}$		35		$\mu\text{V}_{\text{P-P}}$
Hysteresis (Note 6)	$\Delta T = -40^\circ\text{C}$ to 85°C $\Delta T = 0^\circ\text{C}$ to 70°C		160		ppm
			40		ppm

The ● denotes specifications which apply over the full operating temperature range.

Note 1: If the part is stored outside of the specific operating temperature range, the output may shift due to hysteresis.

Note 2: ESD (Electrostatic Discharge) sensitive device. Use proper ESD handling precautions.

Note 3: Output requires $0.1\mu\text{F}$ for operating current greater than 1mA.

Note 4: This parameter is guaranteed by “reverse breakdown change with current” test.

Note 5: Peak-to-peak noise is measured with a single highpass filter at 0.1Hz and 2-pole lowpass filter at 10Hz.

Note 6: Hysteresis in output voltage is created by package stress that differs depending on whether the IC was previously at a higher or lower temperature. Output voltage is always measured at 25°C but the IC is cycled to 85°C or -40°C before successive measurements. Hysteresis is roughly proportional to the square of the temperature change. Hysteresis is not normally a problem for operational temperature excursions where the instrument might be stored at high or low temperature.

1.25V TYPICAL PERFORMANCE CHARACTERISTICS

Reverse Characteristics

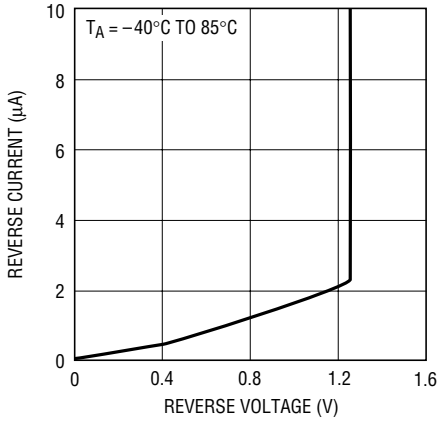

1634-1.25 G01

Temperature Drift

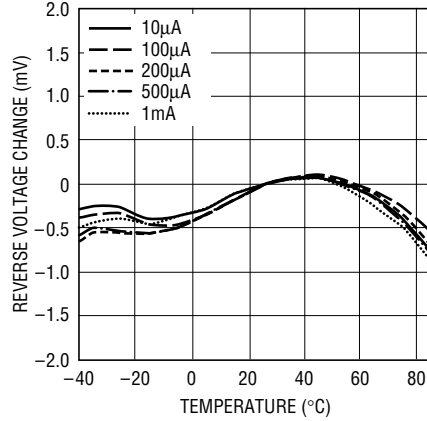

1634-1.25 TA02

Reverse Voltage Change vs Current

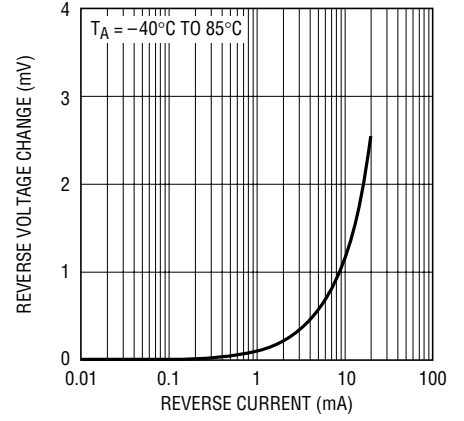

1634-1.25 G03

Reverse Dynamic Impedance

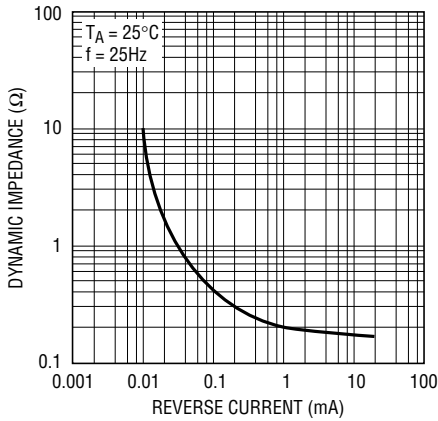

1634-1.25 G04

Dynamic Impedance vs Frequency

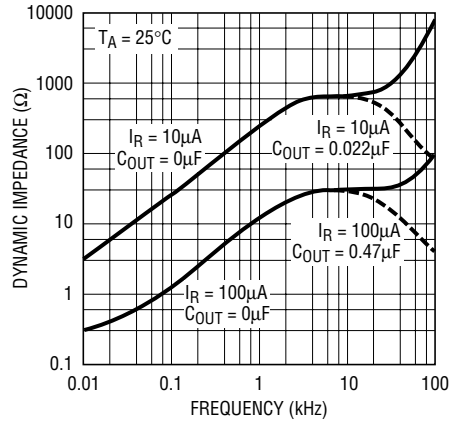

1634-1.25 G05

Forward Characteristics

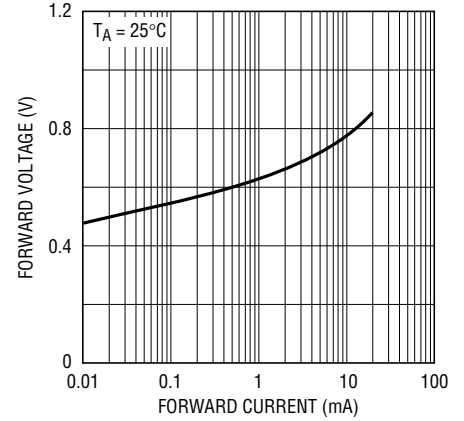

1634-1.25 G06

0.1Hz to 10Hz Noise

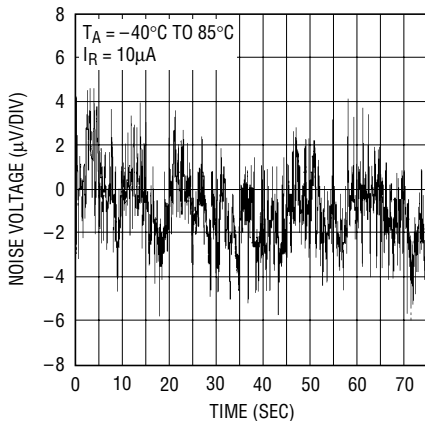

1634-1.25 G07

Response Time

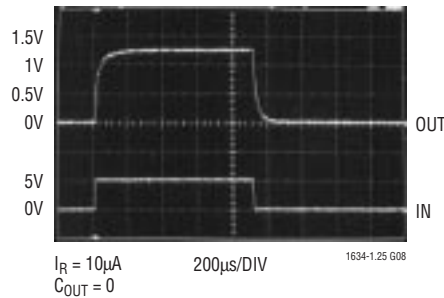

1634-1.25 G08

Response Time

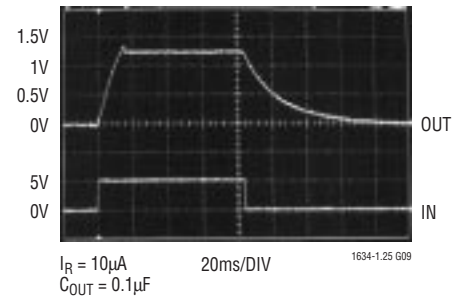

1634-1.25 G09

2.5V TYPICAL PERFORMANCE CHARACTERISTICS

Reverse Characteristics

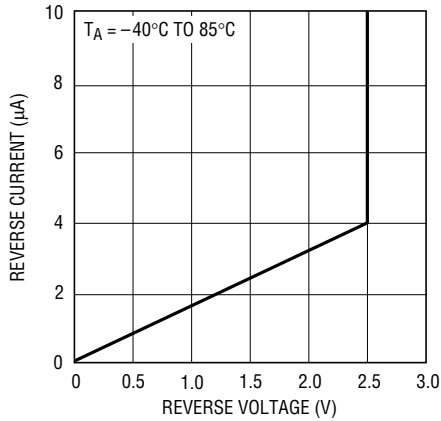

1634-2.5 G01

Temperature Drift

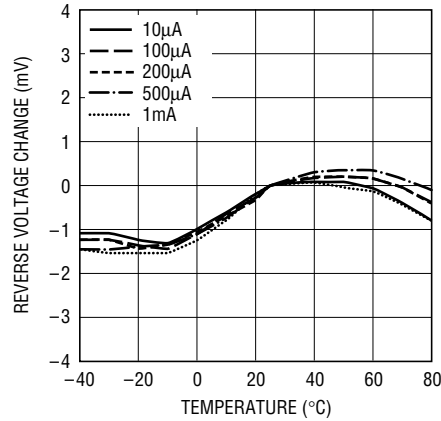

1634-2.5 G02

Reverse Voltage Change vs Current

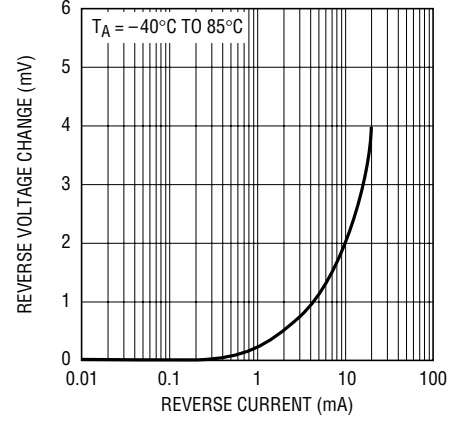

1634-2.5 G03

Reverse Dynamic Impedance

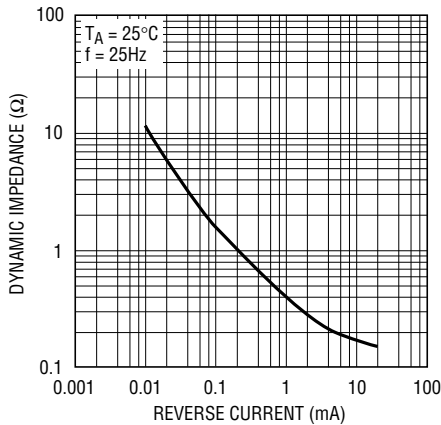

1634-2.5 G04

Dynamic Impedance vs Frequency

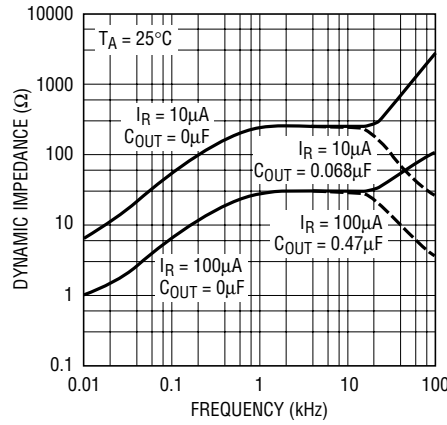

1634-2.5 G05

Forward Characteristics

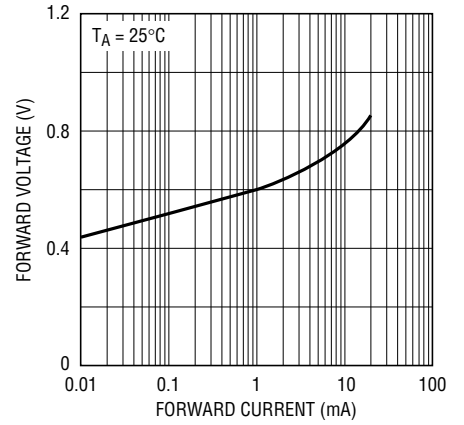

1634-2.5 G06

0.1Hz to 10Hz Noise

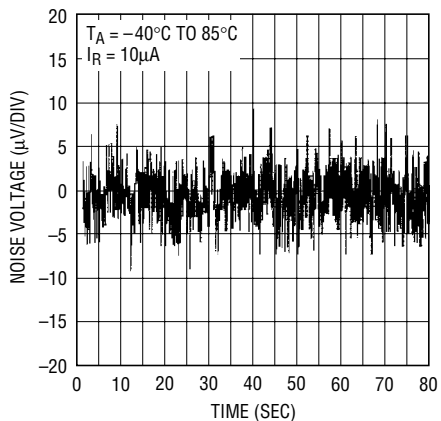

1634-2.5 G07

Response Time

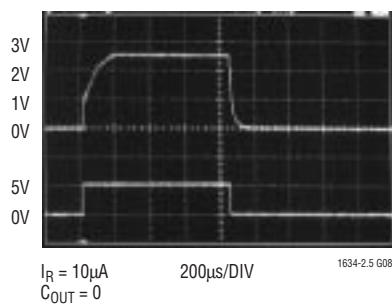

1634-2.5 G08

Response Time

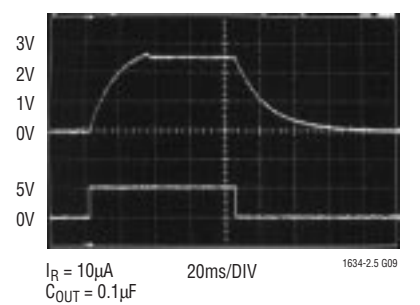

1634-2.5 G09

4.096V TYPICAL PERFORMANCE CHARACTERISTICS

Reverse Characteristics

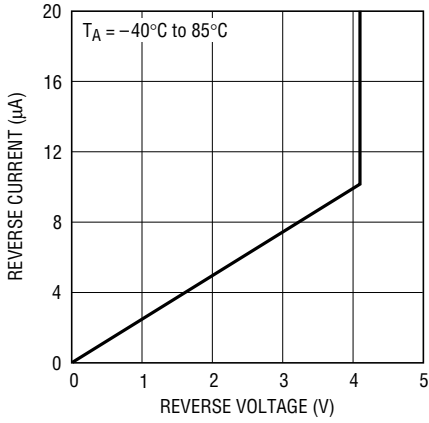

1634-4 G01

Temperature Drift

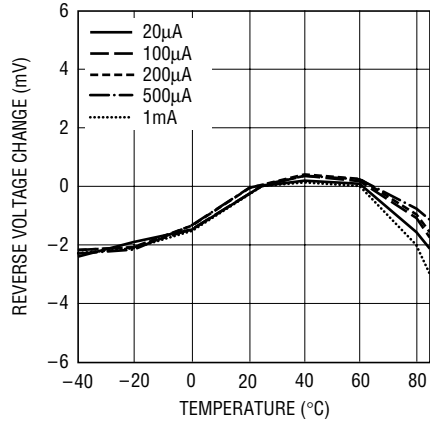

1634-4 G02

Reverse Voltage Change vs Current

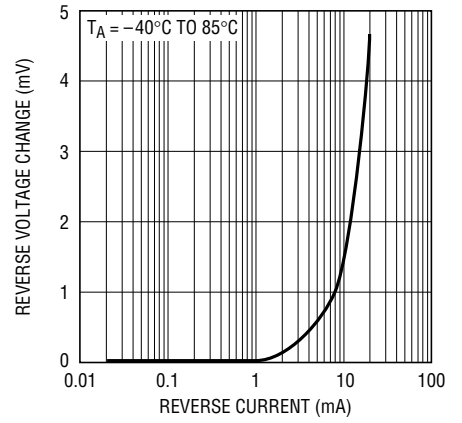

1634-4 G03

Reverse Dynamic Impedance

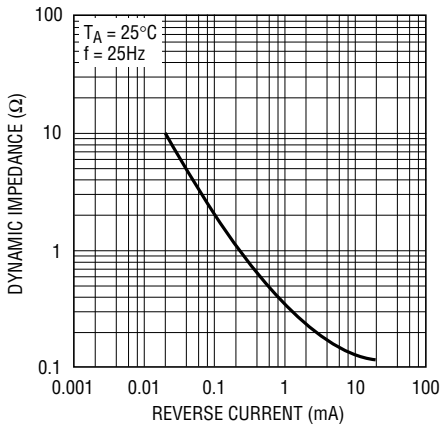

1634-4 G04

Dynamic Impedance vs Frequency

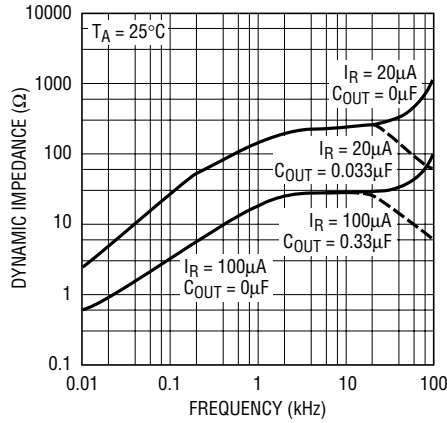

1634-4 G05

Forward Characteristics

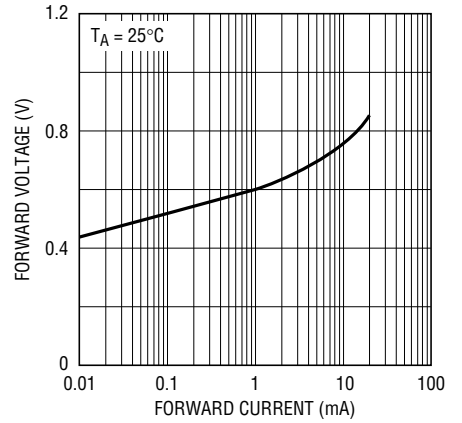

1634-2.5 G06

0.1Hz to 10Hz Noise

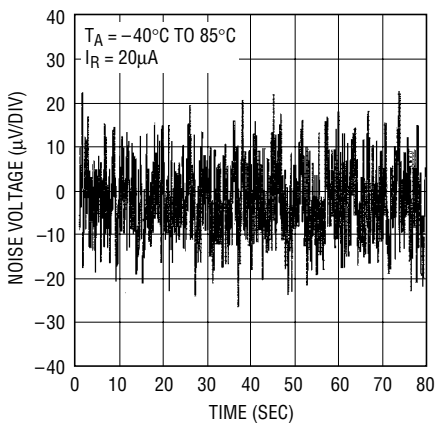

1634-4 G06

Response Time

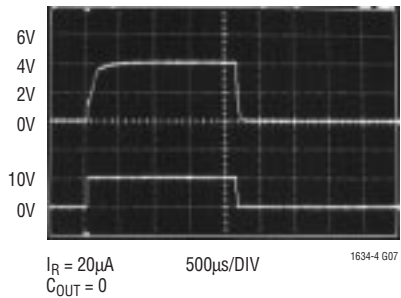

1634-4 G07

Response Time

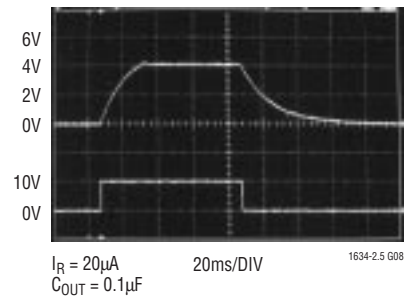

1634-2.5 G08

5V TYPICAL PERFORMANCE CHARACTERISTICS

Reverse Characteristics

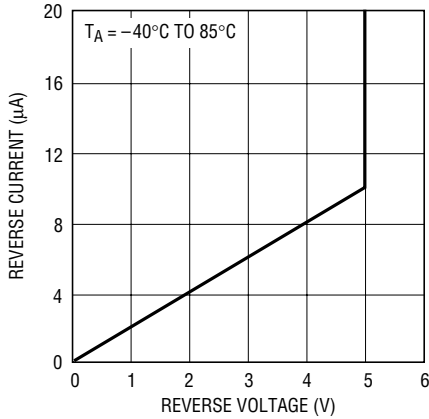

1634-5 G01

Temperature Drift

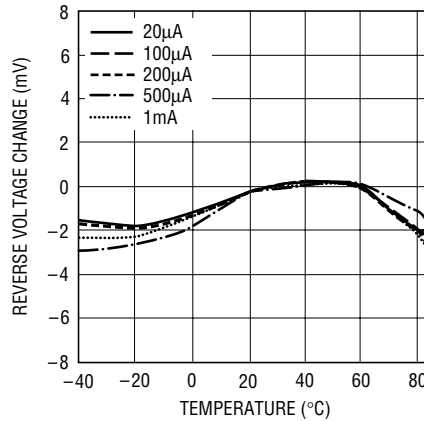

1634-5 G02

Reverse Voltage Change vs Current

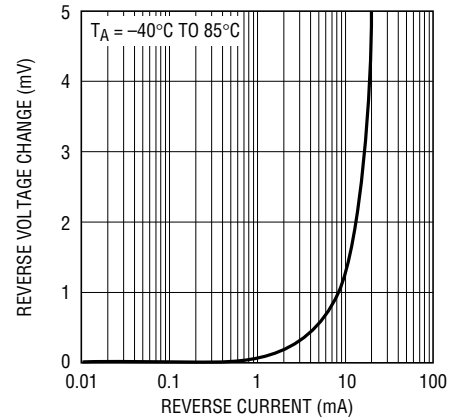

1634-5 G03

Reverse Dynamic Impedance

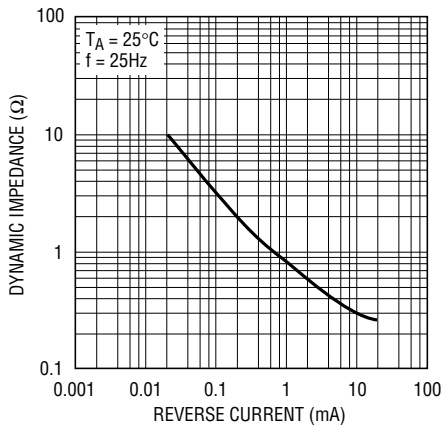

1635-5 G04

Dynamic Impedance vs Frequency

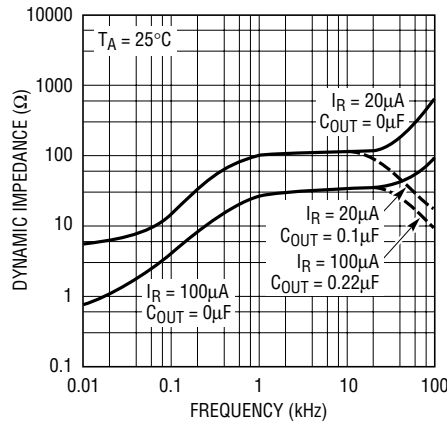

1634-5 G05

Forward Characteristics

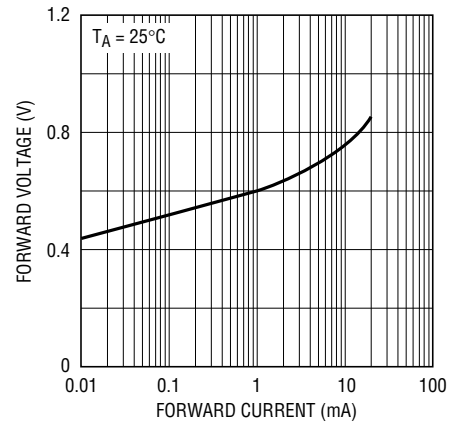

1634-2.5 G06

0.1Hz to 10Hz Noise

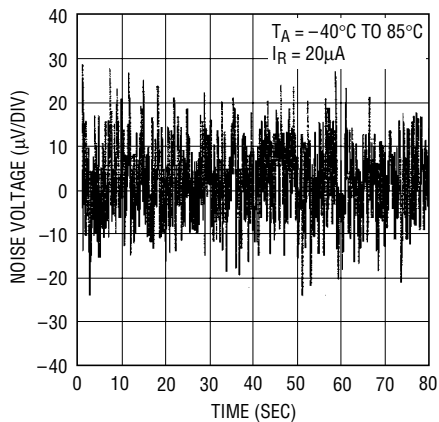

1634-5 G06

Response Time

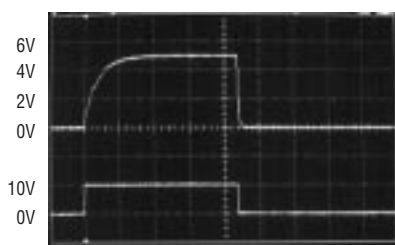

$I_R = 20\mu A$
 $C_{OUT} = 0$ 500µs/DIV 1634-5 G07

Response Time

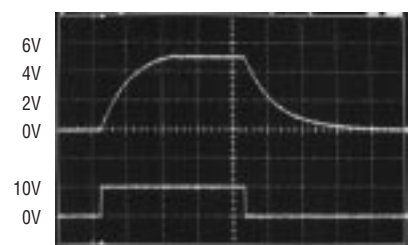

$I_R = 20\mu A$
 $C_{OUT} = 0.1\mu F$ 20ms/DIV 1634-5 G08

APPLICATIONS INFORMATION

The reverse characteristics of the LT1634 behave like a resistor in parallel with a Zener diode. This simple, well behaved characteristic is important to the proper operation of circuits like Figure 1. The adjustable output voltage

reference depends upon positive feedback from the LT1495's output to start-up and regulate the bias current for the LT1634.

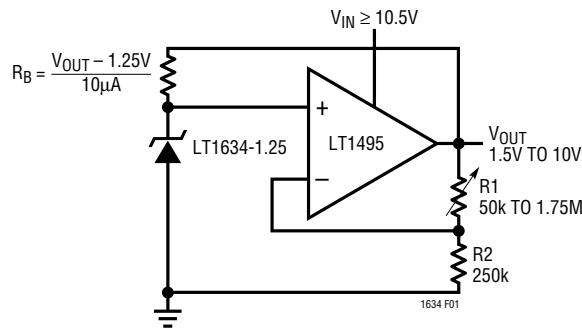
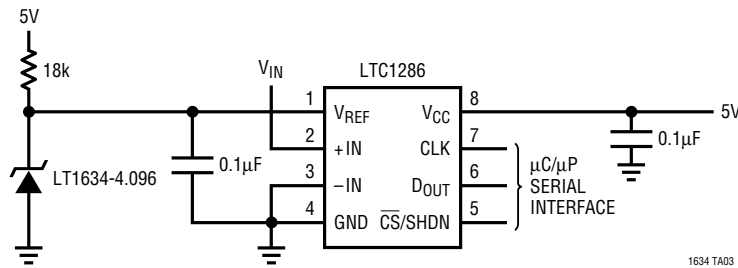

Figure 1. Adjustable Output Voltage Reference

TYPICAL APPLICATIONS

Reference for Micropower A/D Converter



The LT1634-5 Generates the LTC1448 Dual 12-Bit DAC's Reference and Supply Voltage

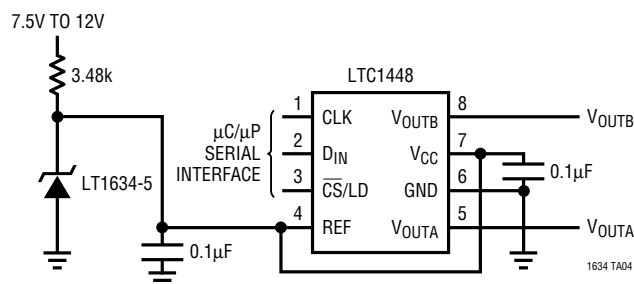

TYPICAL APPLICATIONS

Single Cell Li-Ion Battery Supervisory Circuit ($I_Q = 20\mu A$)

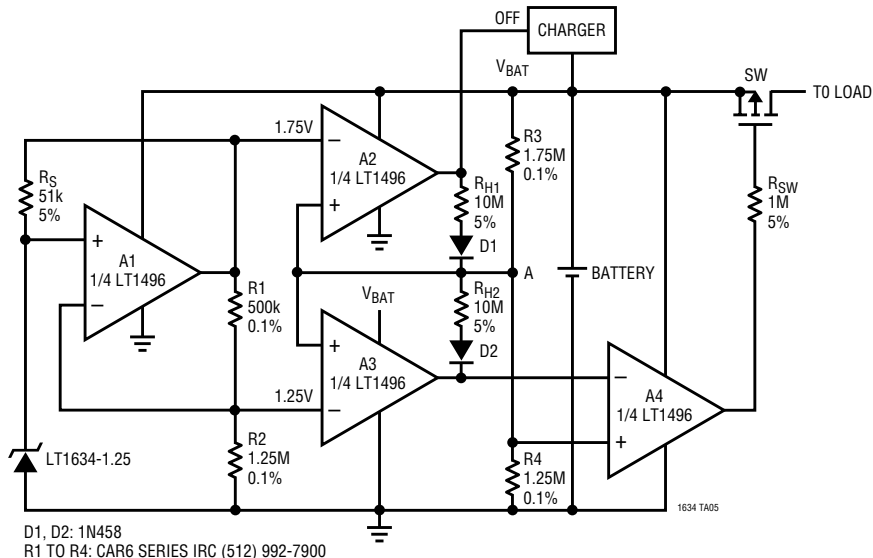

Micropower Voltage and Current Reference

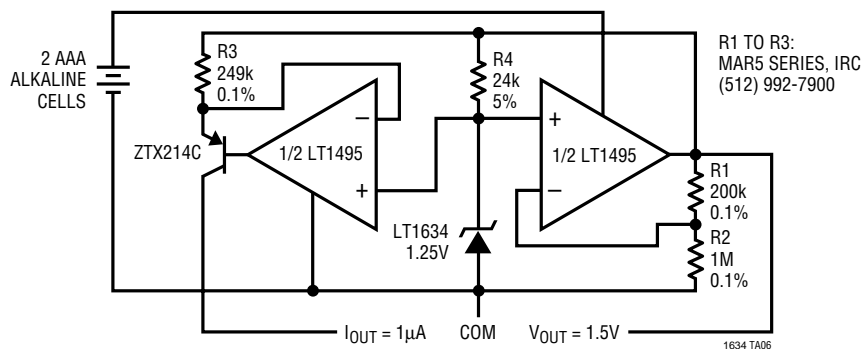

RELATED PARTS

PART NUMBER	DESCRIPTION	COMMENTS
LTC1440	Micropower Comparator with Reference	3.7µA Max Supply Current, 1% 1.182V Reference, MSOP, PDIP and SO-8 Packages
LT1460	Micropower Series Reference	0.075% Max, 10ppm/°C Max Drift, 2.5V, 5V and 10V Versions, MSOP, PDIP, SO-8, SOT-23 and TO-92 Packages
LT1495	1.5µA Precision Rail-to-Rail Dual Op Amp	1.5µA Max Supply Current, 100pA Max I _{OS}
LTC1540	Nanopower Comparator with Reference	600nA Max Supply Current, 2% 1.182V Reference, MSOP and SO-8 Packages