

75 Ω VIDEO LINE DRIVER

FEATURES

- Fixed Gain (6 dB)
- Internal 75 Ω Drivers
- Very Small Output Capacitor Using SAG Function Pin
- Active High ON/OFF Control
- Very Low Standby Current (typ. $I_{STBY} \leq 25 \mu A$)
- Very Small SOT23L-8 Package

APPLICATIONS

- Video Equipment
- Digital Cameras
- CCD Cameras
- TV Monitors
- Video Tape Recorders
- LCD Projectors

DESCRIPTION

Operating from a single +5 V supply, the TK15407 is a dual video driver IC that takes standard video signals as analog inputs and provides buffered analog outputs for driving 150 Ω loads (series 75 Ω resistor and 75 Ω cable load). Both amplifiers have a fixed gain of 6 dB and can be used in series for 12 dB gain. The luminance (Y) input is clamped at 1.29 V and amplified 6 dB to produce 2 V_{P-P} (typical) into a series 75 Ω resistor and 75 Ω cable load. The internal 1.5 k SAG function resistor provides gain compensation for low frequency signals. The chrominance (C) input is biased at 2.6 V and amplified 6 dB to produce 1.1 V_{P-P} (typical) into a series 75 Ω resistor and 75 Ω cable load. During standby (Pin 3 grounded), the TK15407 consumes only 119 μW of power. Nominal power dissipation (no input) is typically 76 mW. The TK15407 is ideally suited for S-VHS systems.

The TK15407M is available in the very small SOT23L-8 surface mount package.

ORDERING INFORMATION

TK15407M □□

Tape/Reel Code

TAPE/REEL CODE
TL: Tape Left

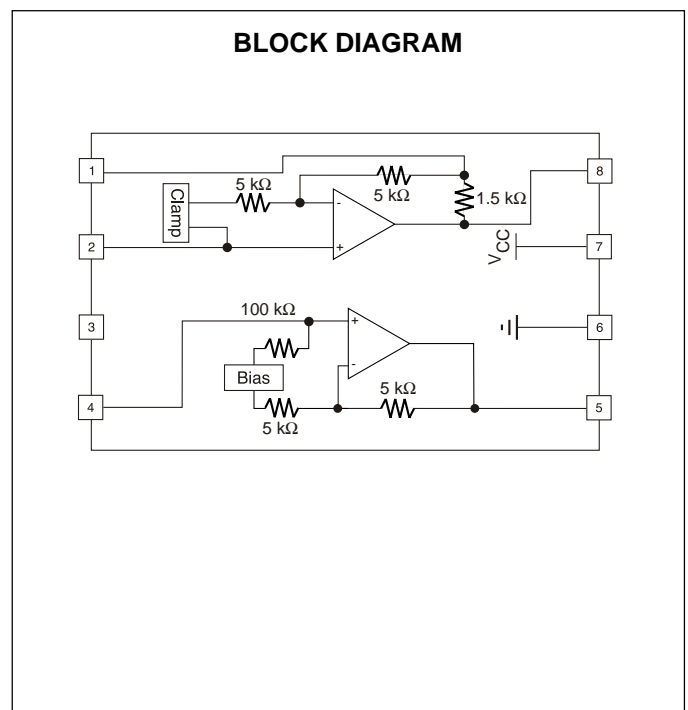
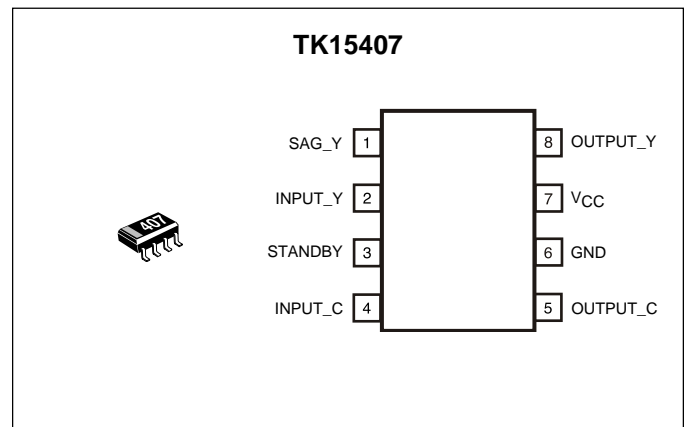

TK15407

ABSOLUTE MAXIMUM RATINGS

Supply Voltage 6 V Storage Temperature Range -55 to +150 °C
 Operating Voltage Range 4.5 to 5.5 V Operating Temperature Range -25 to +75 °C
 Power Dissipation (Note 1) 200 mW

TK15407M ELECTRICAL CHARACTERISTICS

Test conditions: $V_{CC} = 5.0\text{ V}$, $V_{IN} = 1.0\text{ V}_{P-P}$, $R_L = 150\ \Omega$, $T_A = 25\ ^\circ\text{C}$ unless otherwise specified.

SYMBOL	PARAMETER	TEST CONDITIONS	MIN	TYP	MAX	UNITS
I_{CC}	Supply Current	No input		15.1	21.0	mA
I_{STBY}	Standby Supply Current	Pin 3 Grounded		23.8	50.0	μA
I_{OS}	Standby Terminal Current	Pin 3 in Standby mode		23.8	50.0	μA
V_{THL}	Threshold Voltage (High to Low)	Pin 3 Operating to Standby mode	GND	0.1	0.3	V
V_{TLH}	Threshold Voltage (Low to High)	Pin 3 Standby to Operating mode	1.8	2.0	V_{CC}	V
V_{CMP}	Clamp Voltage	Pin 2 Y Signal Input terminal	1.10	1.29	1.50	V
V_{BIAS}	Bias Voltage	Pin 4 C Signal Input terminal	2.35	2.66	2.95	V
GVA	Voltage Gain	$f_{in} = 1\text{ MHz}$	5.2	5.7	6.2	dB
DG	Differential Gain (Y Signal)	Staircase signal input	-3.0	+1.3	+3.0	%
DP	Differential Phase (Y Signal)	Staircase signal input	-3.0	0.0	+3.0	deg
fr	Frequency Response	$f_{in} = 1\text{ MHz} / 5\text{ MHz}$		-0.3		dB
THD	Total Harmonic Distortion (C Signal)	$f_{in} = 1.0\text{ kHz}$		0.4	1.5	%
$V_{OUT(MAX)}$	Maximum Output Voltage (C Signal)	THD = 10% point	0.9	1.1		Vrms

Note 1: Power dissipation is 200 mW in free air. Derate at 1.6 mW/°C for operation above 25°C.

MEASUREMENT METHOD (CONT.)

10. Differential Phase (DP)

The differential phase is measured at TP3 when a staircase waveform of 10 steps is applied to TP1.

11. Frequency Response (fr)

The frequency response equation is as follows:

$$fr = 20 \log_{10} V_2/V_1$$

Where V_1 is the measured TP3 (TP6) voltage when the TP1 (TP4) input frequency is set to 1 MHz and V_2 is the measured TP3 (TP6) voltage when the TP1 (TP4) input frequency is set to 5 MHz.

12. Total Harmonic Distortion (THD)

The TP6 signal is measured when a 1 kHz 1 V_{p-p} input signal is applied to TP4.

13. Maximum Output Voltage ($V_{OUT(MAX)}$)

A 1 kHz input signal is applied to TP4 and the amplitude is slowly increased. The output voltage at TP5 is measured at the point the THD reaches 10%.

TYPICAL PERFORMANCE CHARACTERISTICS

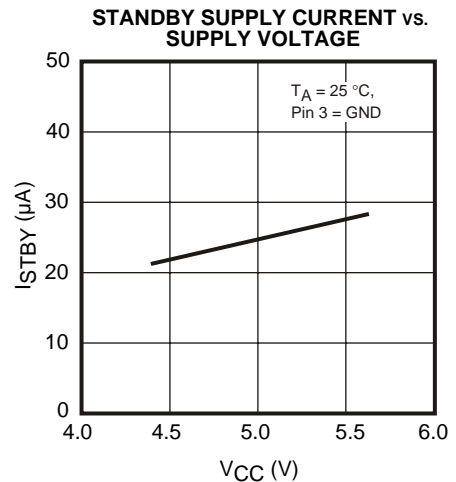
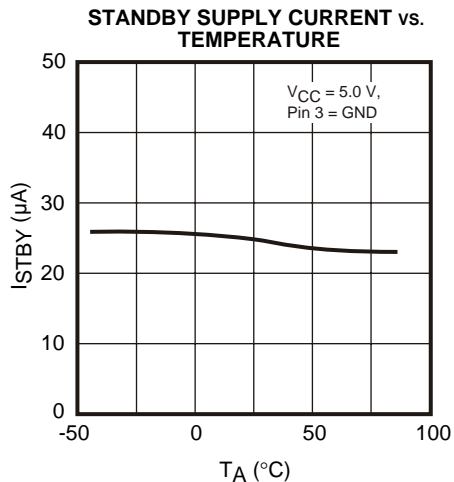
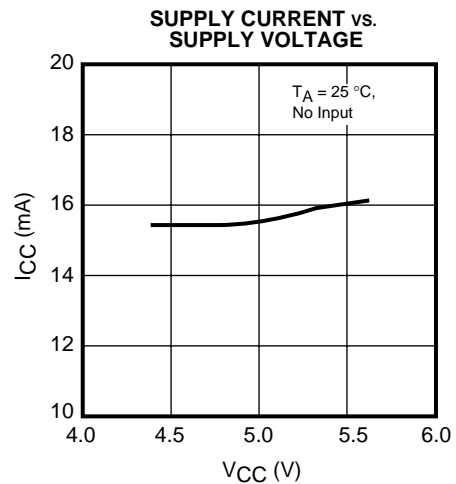
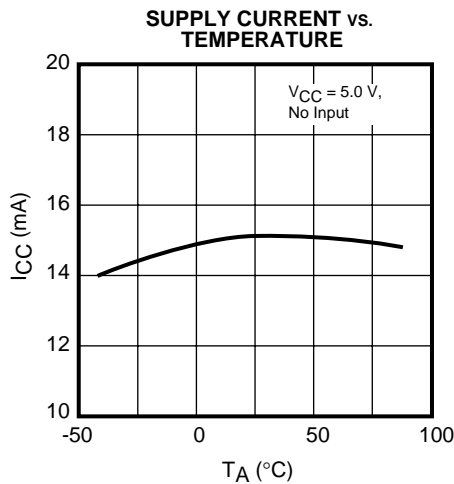

TYPICAL PERFORMANCE CHARACTERISTICS (CONT.)

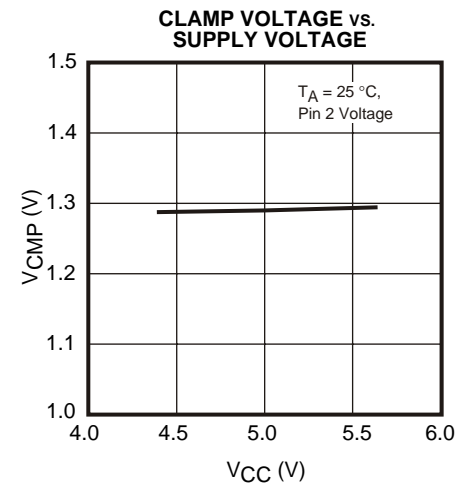
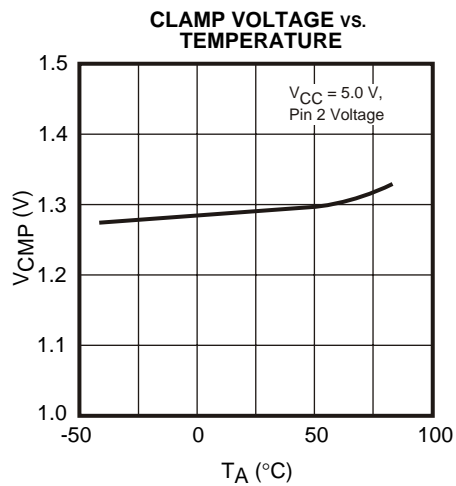
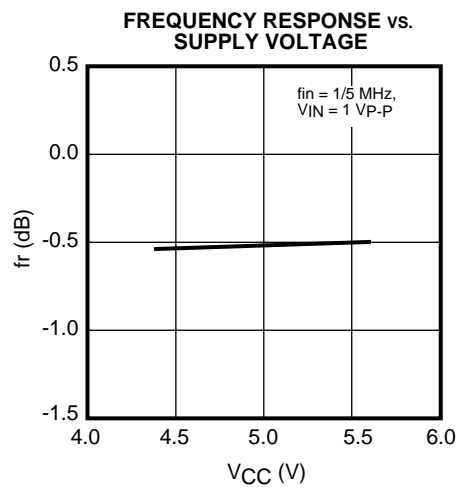
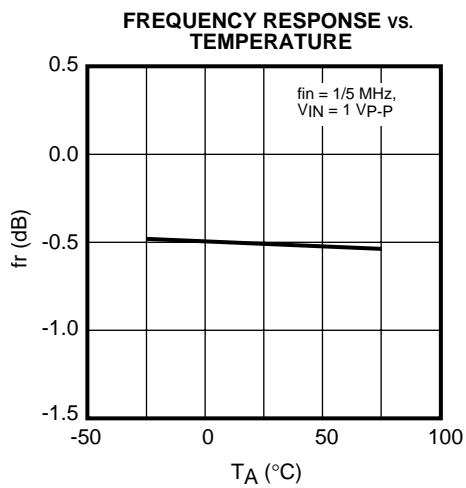
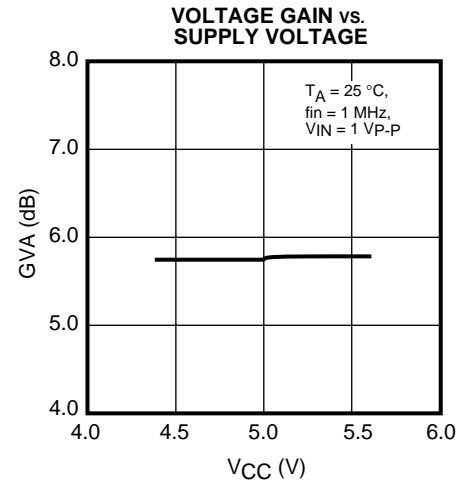
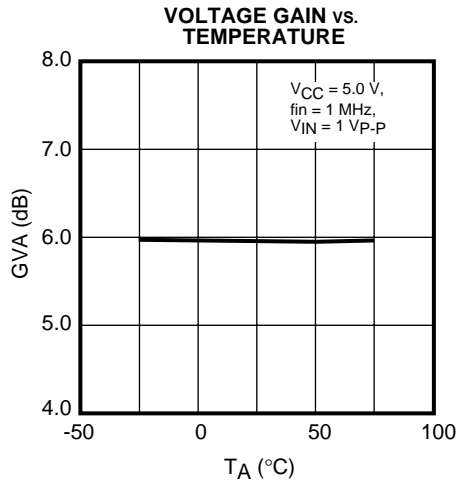

TYPICAL PERFORMANCE CHARACTERISTICS (CONT.)

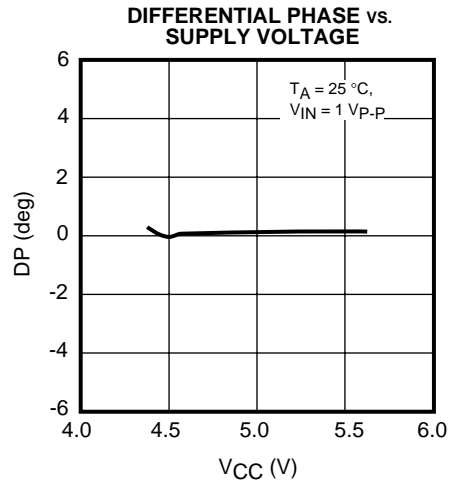
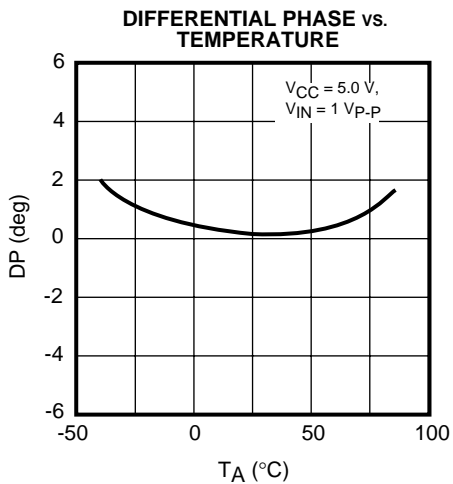
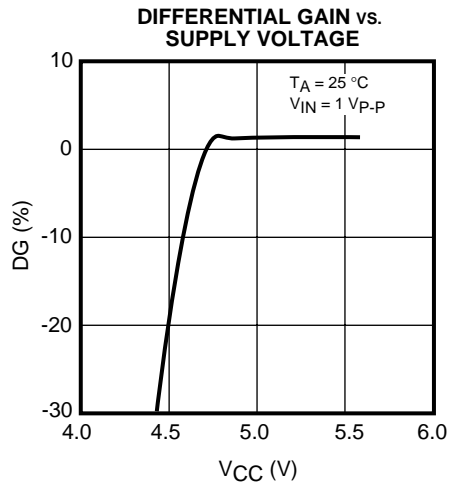
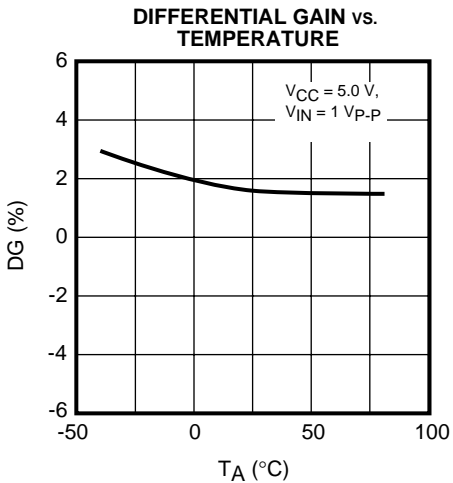
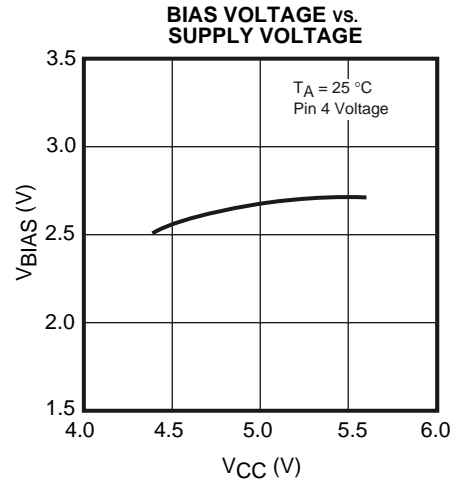
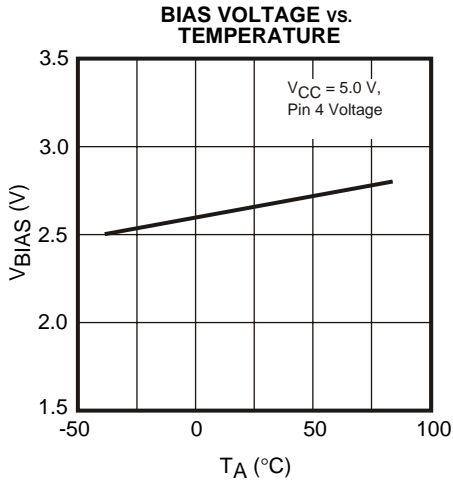

PIN FUNCTION DESCRIPTIONS

TERMINAL			INTERNAL EQUIVALENT CIRCUIT	DESCRIPTION
PIN NO.	SYMBOL	VOLTAGE		
8 1	OUTPUT_Y SAG_Y	1.6 V 1.4 V		<p>Pin 8: Luminance Output terminal. The Luminance output is available to drive $75\ \Omega + 75\ \Omega$ load.</p> <p>Pin 1: SAG terminal</p>
2	INPUT_Y	1.3 V		<p>Luminance Input terminal. The luminance input signal is clamped at 1.29 V.</p>
3	STANDBY	2.1 V		<p>Standby Logic terminal. The device is in the standby mode when Pin 3 is connected to Low. The device is in the operating mode when Pin 3 is connected to High or Open.</p>
4	INPUT_C	2.6 V		<p>Chrominance Input terminal. The chrominance input signal is biased by a $100\ \text{k}\Omega$ Bias Resistance.</p>
5	OUTPUT_C	2.8 V		<p>Chrominance Output terminal. The chrominance output is available to drive $75\ \Omega + 75\ \Omega$ load.</p>
6	GND	GND		GND terminal.
7	V_{CC}	V_{CC}		Power Supply terminal.

PACKAGE OUTLINE

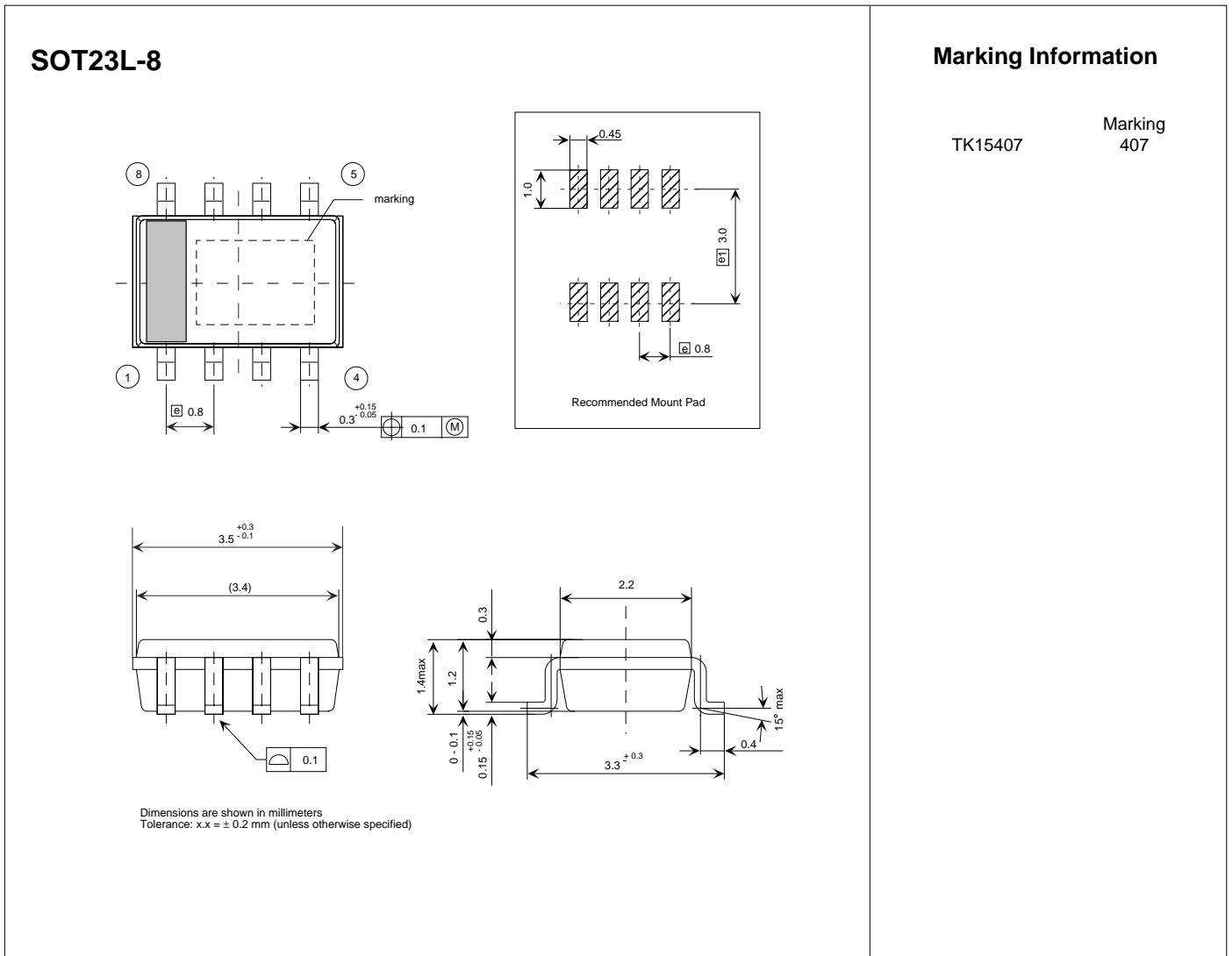

Toko America, Inc. Headquarters
1250 Feehanville Drive, Mount Prospect, Illinois 60056
Tel: (847) 297-0070 Fax: (847) 699-7864

TOKO AMERICA REGIONAL OFFICES

Midwest Regional Office
Toko America, Inc.
1250 Feehanville Drive
Mount Prospect, IL 60056
Tel: (847) 297-0070
Fax: (847) 699-7864

Western Regional Office
Toko America, Inc.
2480 North First Street, Suite 260
San Jose, CA 95131
Tel: (408) 432-8281
Fax: (408) 943-9790

Eastern Regional Office
Toko America, Inc.
107 Mill Plain Road
Danbury, CT 06811
Tel: (203) 748-6871
Fax: (203) 797-1223

Semiconductor Technical Support
Toko Design Center
4755 Forge Road
Colorado Springs, CO 80907
Tel: (719) 528-2200
Fax: (719) 528-2375

Visit our Internet site at <http://www.tokoam.com>

The information furnished by TOKO, Inc. is believed to be accurate and reliable. However, TOKO reserves the right to make changes or improvements in the design, specification or manufacture of its products without further notice. TOKO does not assume any liability arising from the application or use of any product or circuit described herein, nor for any infringements of patents or other rights of third parties which may result from the use of its products. No license is granted by implication or otherwise under any patent or patent rights of TOKO, Inc.