

Buffered H-Bridge

FEATURES

- 1.0-A H-Bridge
- 200-kHz Switching Rate
- Shoot-Through Limited
- TTL Compatible Inputs
- 3.8- to 13.2-V Operating Range
- Surface Mount Packaging

APPLICATIONS

- VCM Driver
- Brushed Motor Driver
- Stepper Motor Driver
- Power Converter
- Optical Disk Drives
- Power Supplies
- High Performance Servo

DESCRIPTION

The Si9986 is an integrated, buffered H-bridge with TTL compatible inputs and the capability of delivering a continuous 1.0 A @ $V_{DD} = 12$ V (room temperature) at switching rates up to 200 kHz. Internal logic prevents the upper and lower outputs of either half-bridge from being turned on

simultaneously. Unique input codes allow both outputs to be forced low (for braking) or forced to a high impedance level.

The Si9986 is available in an 8-Pin SOIC package, specified to operate over a voltage range of 3.8 V to 13.2 V and a the commercial temperature range of 0 to 70°C (C suffix) and the industrial temperature range of -40 to 85°C (D suffix).

FUNCTIONAL BLOCK DIAGRAM, PIN CONFIGURATION AND TRUTH TABLE

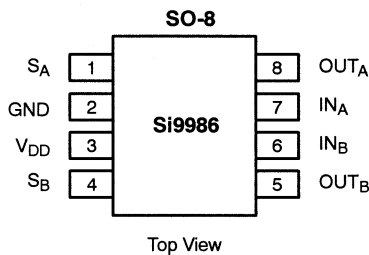

TRUTH TABLE			
IN _A	IN _B	OUT _A	OUT _B
1	0	1	0
0	1	0	1
0	0	0	0
1	1	HiZ	HiZ

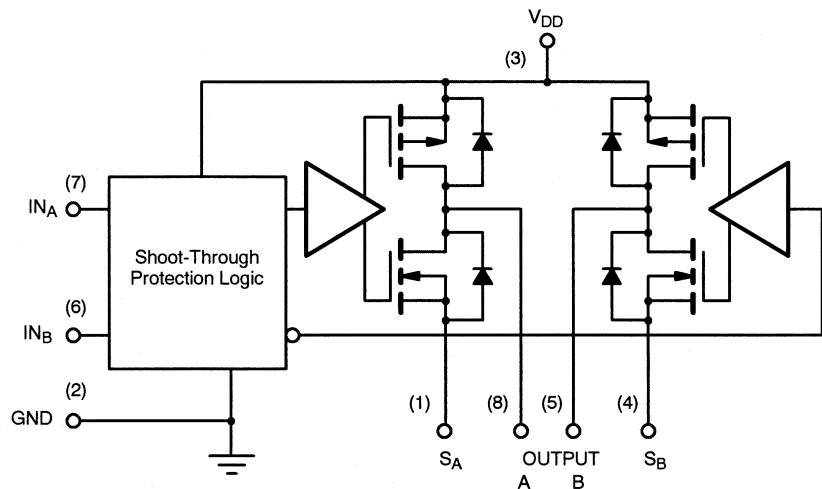

ORDERING INFORMATION		
Part Number	Temperature Range	Package
Si9986CY-T1	0 to 70°C	Tape and Reel
Si9986DY-T1	-40 to 85°C	
Si9986CY	0 to 70°C	Bulk (tubes)
Si9986DY	-40 to 85°C	

**ABSOLUTE MAXIMUM RATINGS^a**

Voltage on any pin with respect to ground	-0.3 V to $V_{DD} + 0.3$ V
Voltage on pins 5, 8 with respect to GND	-1 V to $V_{DD} + 1$ V
Voltage on pins 1, 4	-0.3 V to GND + 1 V
Peak Output Current	1.5 A
Storage Temperature	-65 to 150°C
Maximum Junction Temperature (T_J)	150°C
Maximum V_{DD}	15 V

Power Dissipation ^b	1 W
Θ_{JA}	100°C/W
Operating Temperature Range	
Si9986CY	0 to 70°C
Si9986DY	-40 to 85°C

Notes

- a. Device mounted with all leads soldered or welded to PC board.
b. Derate 10 mW/°C above 25°C.

RECOMMENDED OPERATING RANGE

V_{DD}	3.8 V to 13.2 V
Maximum Junction Temperature (T_J)	125°C

SPECIFICATIONS							
Parameter	Symbol	Test Conditions Unless Specified $V_{DD} = 3.8$ to 13.2 V S_A @ GND, S_B @ GND		Limits			Unit
				Min ^a	Typ ^b	Max ^a	
Input							
Input Voltage High	V_{INH}		2				V
Input Voltage Low	V_{INL}				1		
Input Current with Input Voltage High	I_{INH}	$V_{IN} = 2$ V			1		μ A
Input Current with Input Voltage Low	I_{INL}	$V_{IN} = 0$ V	-1				
Output							
Output Voltage High	V_{OUTH}	$I_{OUT} = -500$ mA	$V_{DD} = 10.8$ V	10.5	10.7		V
			$V_{DD} = 4.5$ V	4.1	4.3		
		$I_{OUT} = -300$ mA, $V_{DD} = 3.8$ V		3.4	3.7		
Output Voltage Low	V_{OUTL}	$I_{OUT} = 500$ mA	$V_{DD} = 10.8$ V		0.2	0.3	V
			$V_{DD} = 4.5$ V		0.2	0.4	
		$I_{OUT} = 300$ mA, $V_{DD} = 3.8$ V			0.1	0.4	
Output Leakage Current Low	I_{OLL}	$V_{OUT} = 0$, $V_{DD} = 13.2$ V	-10	0			μ A
Output Leakage Current High	I_{OLH}	$I_{NA} = I_{NB} \geq 2$ V, $V_{OUT} = V_{DD} = 13.2$ V		0	10		
Output V Clamp High	V_{CLH}	$I_{NA} = I_{NB} \geq 2$ V	$I_{OUT} = 100$ mA		$V_{DD} + 0.7$		V
Output V Clamp Low	V_{CLL}		$I_{OUT} = -100$ mA		-0.7		
Supply							
V_{DD} Supply Current	I_{DD}	$I_N = 100$ kHz, $V_{DD} = 5.5$ V		2			mA
		$I_{NA} = I_{NB} = 4.5$ V, $V_{DD} = 5.5$ V				300	μ A
Dynamic							
Propagation Delay Time	T_{PHH}	$V_{DD} = 5.5$ V		300			nS
	T_{PHL}			100			

Notes

- a. The algebraic convention whereby the most negative value is a minimum and the most positive a maximum, is used in this data sheet.
b. Typical values are for DESIGN AID ONLY, not guaranteed nor subject to production testing.

TYPICAL CHARACTERISTICS (25°C UNLESS OTHERWISE NOTED)

Output High Voltage vs. Output Current

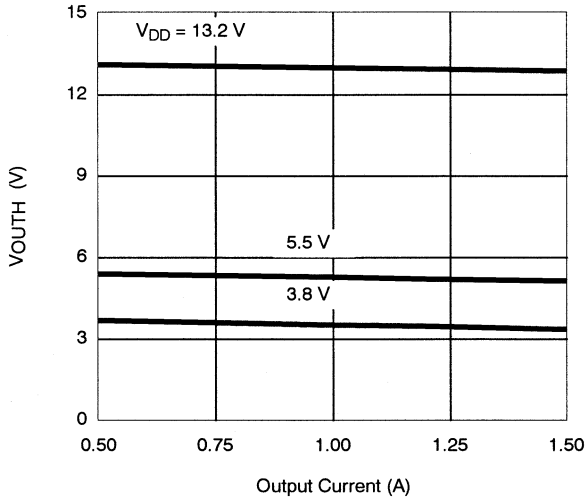

Output Low Voltage vs. Output Current

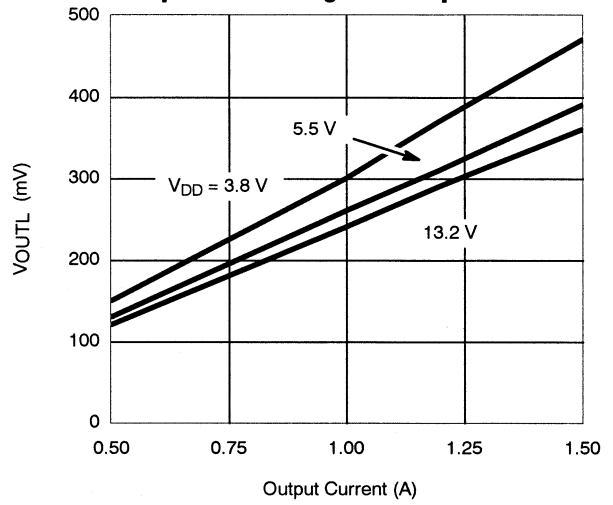

Supply Current vs. Supply Voltage

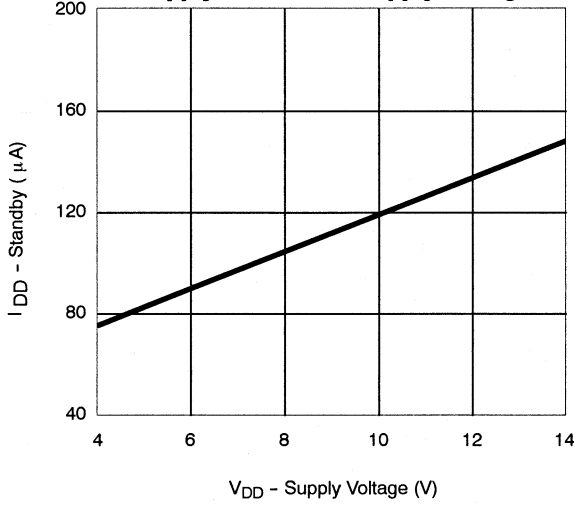

Supply Current vs. Supply Voltage

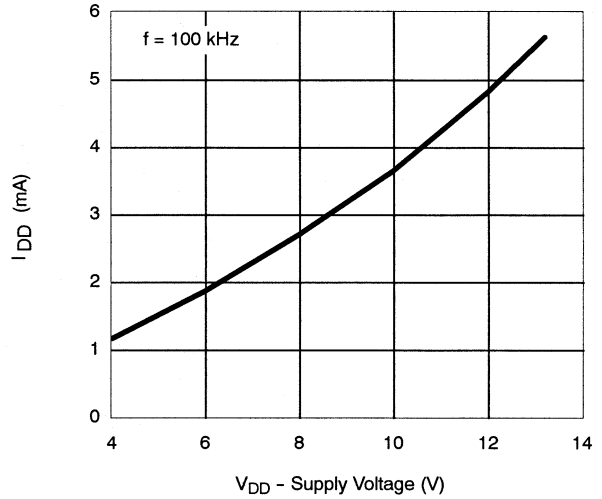

Supply Current vs. Temperature

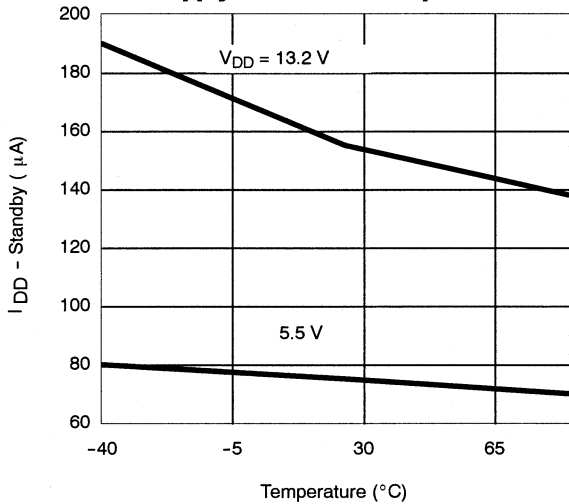

Supply Current vs. Temperature

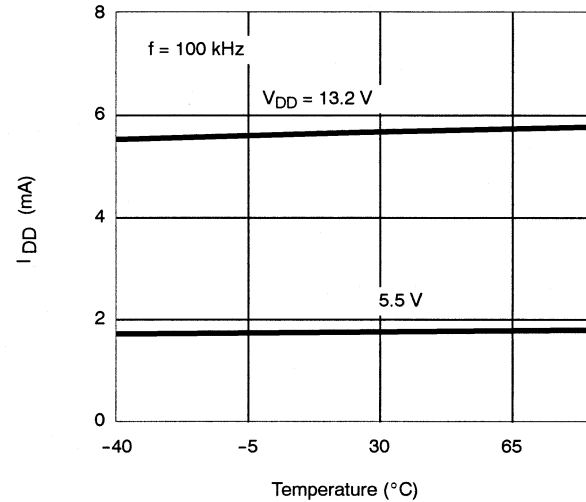



TYPICAL CHARACTERISTICS (25°C UNLESS OTHERWISE NOTED)

