

74VHC175 Quad D-Type Flip-Flop

General Description

The VHC175 is an advanced high-speed CMOS device fabricated with silicon gate CMOS technology. It achieves the high-speed operation similar to equivalent Bipolar Schottky TTL while maintaining the CMOS low power dissipation.

The VHC175 is a high-speed quad D-type flip-flop. The device is useful for general flip-flop requirements where clock and clear inputs are common. The information on the D inputs is stored during the LOW-to-HIGH clock transition. Both true and complemented outputs of each flip-flop are provided. A Master Reset input resets all flip-flops, independent of the Clock or D inputs, when LOW.

An input protection circuit insures that 0V to 7V can be applied to the input pins without regard to the supply volt-

age. This device can be used to interface 5V to 3V systems and two supply systems such as battery backup. This circuit prevents device destruction due to mismatched supply and input voltages.

Features

- High Speed: $f_{MAX} = 210$ MHz (typ) at $V_{CC} = 5V$
- Low power dissipation: $I_{CC} = 4$ μA (max) at $T_A = 25^\circ C$
- High noise immunity: $V_{NIH} = V_{NIL} = 28\%$ V_{CC} (min)
- Power down protection is provided on all inputs
- Low noise: $V_{OLP} = 0.8V$ (max)
- Pin and function compatible with 74HC175

Ordering Code:

Order Number	Package Number	Package Description
74VHC175M	M16A	16-Lead Small Outline Integrated Circuit (SOIC), JEDEC MS-012, 0.150 Narrow
74VHC175SJ	M16D	16-Lead Small Outline Package (SOP), EIAJ TYPE II, 5.3mm Wide
74VHC175MTC	MTC16	16-Lead Thin Shrink Small Outline Package (TSSOP), JEDEC MO-153, 4.4mm Wide
74VHC175N	N16E	16-Lead Plastic Dual-In-Line Package (PDIP), JEDEC MS-001, 0.300 Wide

Surface mount packages are also available on Tape and Reel. Specify by appending the suffix letter "X" to the ordering code.

Connection Diagram

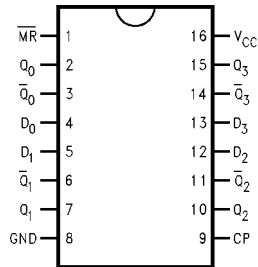

Pin Descriptions

Pin Names	Description
D_0 - D_3	Data Inputs
CP	Clock Pulse Input
\overline{MR}	Master Reset Input
Q_0 - Q_3	True Outputs
$\overline{Q_0}$ - $\overline{Q_3}$	Complement Outputs

Logic Symbols

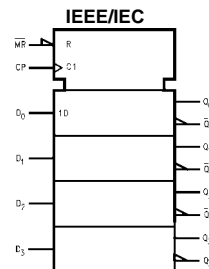
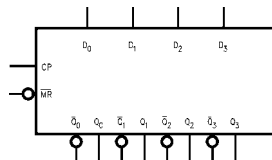

Functional Description

The VHC175 consists of four edge-triggered D flip-flops with individual D inputs and Q and \bar{Q} outputs. The Clock and Master Reset are common. The four flip-flops will store the state of their individual D inputs on the LOW-to-HIGH clock (CP) transition, causing individual Q and \bar{Q} outputs to follow. A LOW input on the Master Reset (\bar{MR}) will force all Q outputs LOW and \bar{Q} outputs HIGH independent of Clock or Data inputs. The VHC175 is useful for general logic applications where a common Master Reset and Clock are acceptable.

Truth Table

Inputs		Outputs	
@ t_n , $\bar{MR} = H$		@ t_{n+1}	
D_n		Q_n	\bar{Q}_n
L		L	H
H		H	L

H = HIGH Voltage Level
 L = LOW Voltage Level
 t_n = Bit Time before Clock Pulse
 t_{n+1} = Bit Time after Clock Pulse

Logic Diagram

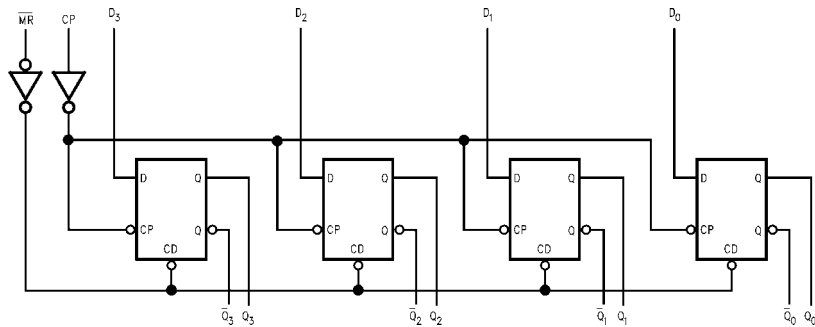

Please note that this diagram is provided only for the understanding of logic operations and should not be used to estimate propagation delays.

Absolute Maximum Ratings (Note 1)

Supply Voltage (V_{CC})	-0.5V to +7.0V
DC Input Voltage (V_{IN})	-0.5V to +7.0V
DC Output Voltage (V_{OUT})	-0.5V to $V_{CC} + 0.5V$
Input Diode Current (I_{IK})	-20 mA
Output Diode Current (I_{OK})	± 20 mA
DC Output Current (I_{OUT})	± 25 mA
DC V_{CC} /GND Current (I_{CC})	± 50 mA
Storage Temperature (T_{STG})	-65°C to +150°C
Lead Temperature (T_L) (Soldering, 10 seconds)	260°C

Recommended Operating Conditions (Note 2)

Supply Voltage (V_{CC})	2.0V to +5.5V
Input Voltage (V_{IN})	0V to +5.5V
Output Voltage (V_{OUT})	0V to V_{CC}
Operating Temperature (T_{OPR})	-40°C to +85°C
Input Rise and Fall Time (t_r, t_f)	
$V_{CC} = 3.3V \pm 0.3V$	0 ~ 100 ns/V
$V_{CC} = 5.0V \pm 0.5V$	0 ~ 20 ns/V

Note 1: Absolute Maximum Ratings are values beyond which the device may be damaged or have its useful life impaired. The databook specifications should be met, without exception, to ensure that the system design is reliable over its power supply, temperature, and output/input loading variables. Fairchild does not recommend operation outside databook specifications.

Note 2: Unused inputs must be held HIGH or LOW. They may not float.

DC Electrical Characteristics

Symbol	Parameter	V_{CC} (V)	$T_A = 25^\circ\text{C}$			$T_A = -40^\circ\text{C to } +85^\circ\text{C}$		Units	Conditions	
			Min	Typ	Max	Min	Max			
V_{IH}	HIGH Level Input Voltage	2.0 3.0 – 5.5	1.50			1.50		V		
V_{IL}	LOW Level Input Voltage	2.0 3.0 – 5.5			0.50 0.3 V_{CC}		0.50 0.3 V_{CC}	V		
V_{OH}	HIGH Level Output Voltage	2.0	1.9	2.0		1.9		V	$V_{IN} = V_{IH}$ or V_{IL}	$I_{OH} = -50 \mu\text{A}$
		3.0	2.9	3.0		2.9				
		4.5	4.4	4.5		4.4		V	$I_{OH} = -4 \text{ mA}$ $I_{OH} = -8 \text{ mA}$	
		3.0	2.58			2.48				
4.5	3.94			3.80						
V_{OL}	LOW Level Output Voltage	2.0		0.0	0.1		0.1	V	$V_{IN} = V_{IH}$ or V_{IL}	$I_{OL} = 50 \mu\text{A}$
		3.0		0.0	0.1		0.1			
		4.5		0.0	0.1		0.1	V	$I_{OL} = 4 \text{ mA}$ $I_{OL} = 8 \text{ mA}$	
		3.0			0.36		0.44			
4.5			0.36		0.44					
I_{IN}	Input Leakage Current	0 – 5.5			± 0.1		± 1.0	μA	$V_{IN} = 5.5V$ or GND	
I_{CC}	Quiescent Supply Current	5.5			4.0		40.0	μA	$V_{IN} = V_{CC}$ or GND	

Noise Characteristics

Symbol	Parameter	V_{CC} (V)	$T_A = 25^\circ\text{C}$		Units	Conditions
			Typ	Limits		
V_{OLP} (Note 3)	Quiet Output Maximum Dynamic V_{OL}	5.0	0.4	0.8	V	$C_L = 50 \text{ pF}$
V_{OLV} (Note 3)	Quiet Output Minimum Dynamic V_{OL}	5.0	-0.4	-0.8	V	$C_L = 50 \text{ pF}$
V_{IHD} (Note 3)	Minimum HIGH Level Dynamic Input Voltage	5.0		3.5	V	$C_L = 50 \text{ pF}$
V_{ILD} (Note 3)	Maximum LOW Level Dynamic Input Voltage	5.0		1.5	V	$C_L = 50 \text{ pF}$

Note 3: Parameter guaranteed by design.

AC Electrical Characteristics

Symbol	Parameter	V _{CC} (V)	T _A = 25°C			T _A = -40°C to +85°C		Units	Conditions
			Min	Typ	Max	Min	Max		
f _{MAX}	Maximum Clock Frequency	3.3 ± 0.3	90	140		75		MHz	C _L = 15 pF
			50	75		45			C _L = 50 pF
		5.0 ± 0.5	150	210		125		MHz	C _L = 15 pF
			85	115		75			C _L = 50 pF
t _{PLH}	Propagation Delay Time (CP to Q _n or \overline{Q}_n)	3.3 ± 0.3		7.5	11.5	1.0	13.5	ns	C _L = 15 pF
				10.0	15.0	1.0	17.0		C _L = 50 pF
t _{PHL}		5.0 ± 0.5		4.8	7.3	1.0	8.5	ns	C _L = 15 pF
				6.3	9.3	1.0	10.5		C _L = 50 pF
t _{PLH}	Propagation Delay Time (MR to Q _n or \overline{Q}_n)	3.3 ± 0.3		6.3	10.1	1.0	12.0	ns	C _L = 15 pF
				8.8	13.6	1.0	15.5		C _L = 50 pF
t _{PHL}		5.0 ± 0.5		4.3	6.4	1.0	7.5	ns	C _L = 15 pF
				5.8	8.4	1.0	9.5		C _L = 50 pF
t _{OSSLH}	Output to Output Skew	3.3 ± 0.3			1.5		1.5		C _L = 50 pF
t _{OSSLH}		5.0 ± 0.5			1.0		1.0		C _L = 50 pF (Note 4)
C _{IN}	Input Capacitance			4	10		10		pF V _{CC} = Open
C _{PD}	Power Dissipation Capacitance			44					pF (Note 5)

Note 4: Parameter guaranteed by design. $t_{OSSLH} = |t_{PLHmax} - t_{PLHmin}|$; $t_{OSSLH} = |t_{PHLmax} - t_{PHLmin}|$.

Note 5: C_{PD} is defined as the value of the internal equivalent capacitance which is calculated from the operating current consumption without load. Average operating current can be obtained from the equation: $I_{CC} (opr.) = C_{PD} \cdot V_{CC} \cdot f_{IN} + I_{CC}/4$ (per F/F), and the total C_{PD} when n pcs of the Flip-Flop operate can be calculated by the following equation: C_{PD} (total) = 30 + 14 • n

AC Operating Requirements

Symbol	Parameter	V _{CC} (V) (Note 6)	T _A = 25°C		T _A = -40°C to +85°C		Units
			Typ	Guaranteed Minimum	Typ	Guaranteed Minimum	
t _{W(L)}	Minimum Pulse Width (CP)	3.3		5.0	5.0	ns	
t _{W(H)}		5.0		5.0	5.0		
t _{W(L)}	Minimum Pulse Width (\overline{MR})	3.3		5.0	5.0	ns	
		5.0		5.0	5.0		
t _S	Minimum Setup Time (Dn to CP)	3.3		5.0	5.0	ns	
		5.0		4.0	4.0		
t _H	Minimum Hold Time (Dn to CP)	3.3		1.0	1.0	ns	
		5.0		1.0	1.0		
t _{REC}	Minimum Removal Time (\overline{MR})	3.3		5.0	5.0	ns	
		5.0		5.0	5.0		

Note 6: V_{CC} is 3.3 ± 0.3V or 5.0 ± 0.5V

Physical Dimensions inches (millimeters) unless otherwise noted

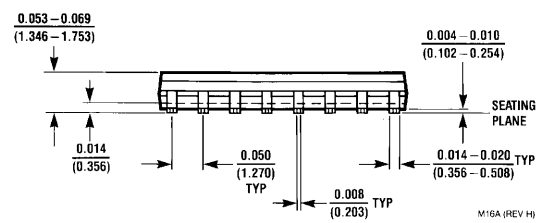
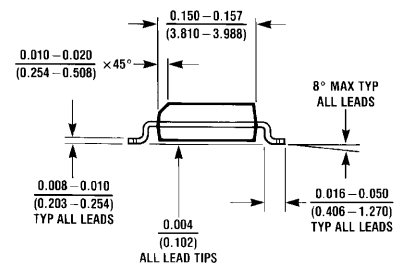
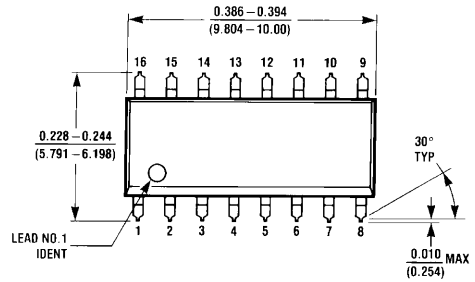

16-Lead Small Outline Integrated Circuit (SOIC), JEDEC MS-012, 0.150 Narrow Package Number M16A

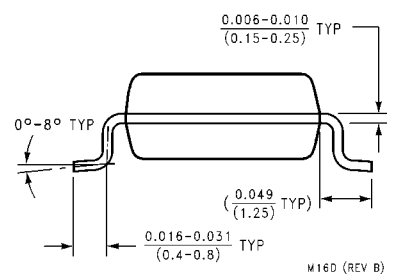
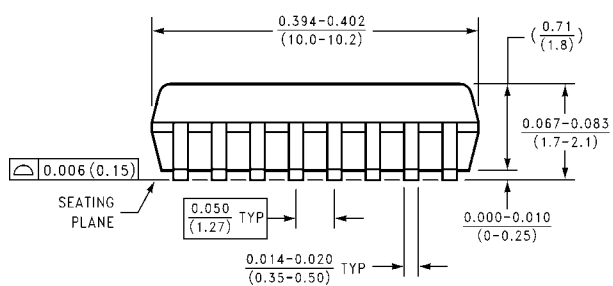
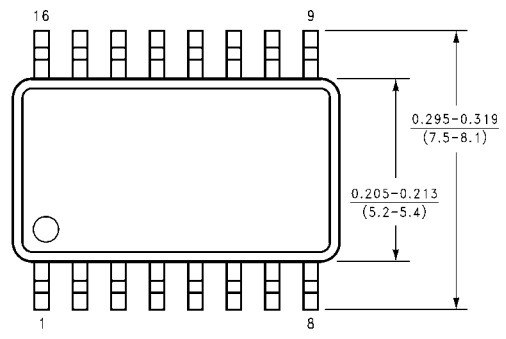

16-Lead Small Outline Package (SOP), EIAJ TYPE II, 5.3mm Wide Package Number M16D

Physical Dimensions inches (millimeters) unless otherwise noted (Continued)

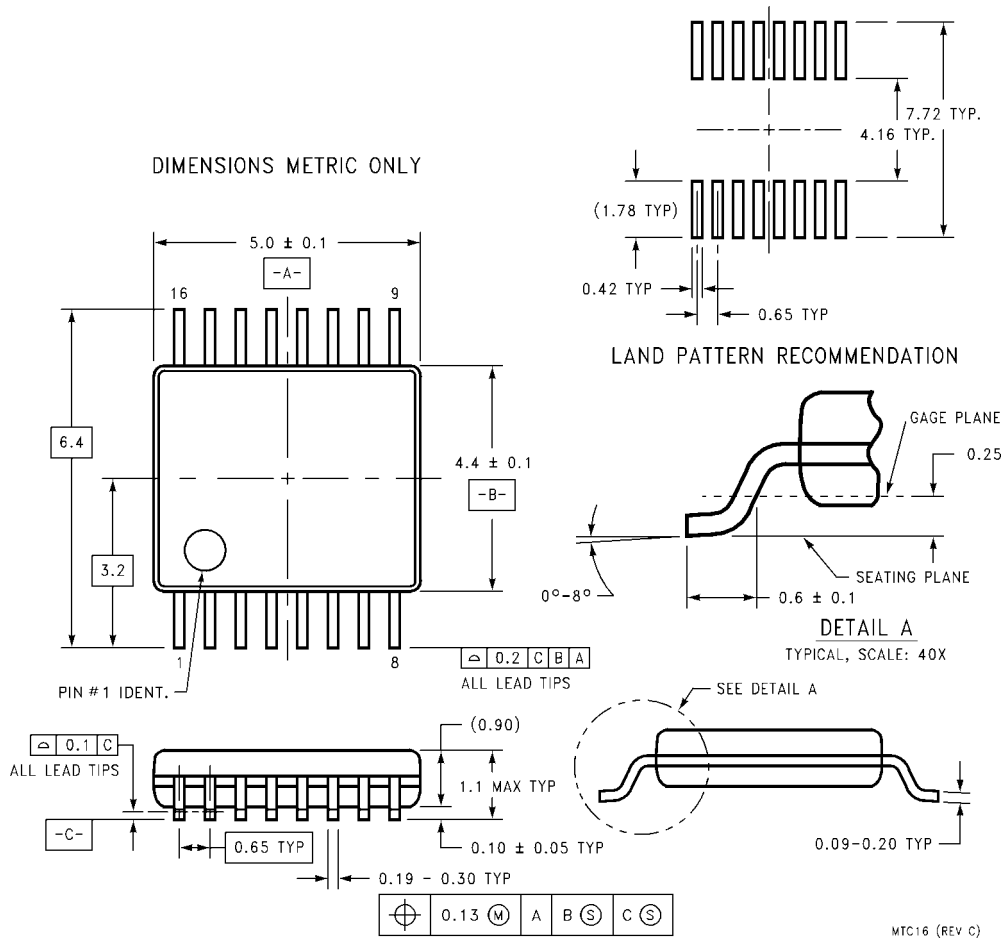

**16-Lead Thin Shrink Small Outline Package (TSSOP), JEDEC MO-153, 4.4mm Wide
Package Number MTC16**

Physical Dimensions inches (millimeters) unless otherwise noted (Continued)



16-Lead Plastic Dual-In-Line Package (PDIP), JEDEC MS-001, 0.300 Wide Package Number N16E

LIFE SUPPORT POLICY

FAIRCHILD'S PRODUCTS ARE NOT AUTHORIZED FOR USE AS CRITICAL COMPONENTS IN LIFE SUPPORT DEVICES OR SYSTEMS WITHOUT THE EXPRESS WRITTEN APPROVAL OF THE PRESIDENT OF FAIRCHILD SEMICONDUCTOR CORPORATION. As used herein:

1. Life support devices or systems are devices or systems which, (a) are intended for surgical implant into the body, or (b) support or sustain life, and (c) whose failure to perform when properly used in accordance with instructions for use provided in the labeling, can be reasonably expected to result in a significant injury to the user.
2. A critical component in any component of a life support device or system whose failure to perform can be reasonably expected to cause the failure of the life support device or system, or to affect its safety or effectiveness.

www.fairchildsemi.com