



EXCEED PERSEVERANCE ELECTRONIC INDUSTRY CO., LTD.

深圳市超毅光电子有限公司

20.0mm STARS TYPE CHRISTMAS LEADS.

Part Number:

RL913-RD312C
RL913-HY212C

RL913-SR112C
RL913-YG412C

RL913-HO312C
RL913-SO422C

Features

- 1.LOW POWER CONSUMPTION.
- 2.RELIABLE AND RUGGED.
- 3.EXCELLENT UNIFORMITY OF LIGHT OUTPUT.
- 4.SUITABLE FOR LEVEL INDICATOR.
- 5.I.C COMPATIBLE.
- 6.LONG LIFE-SOLIDSTATE RELIABILTY.

Notes:

- 1.All dimensions are in millimeters (inches)
- 2.Tolerance is $\pm 0.25(0.01'')$ unless otherwise niter
- 3.Lead spacing is measured where the lead emerge package
- 4.Specifications are subject to change without notice

Package Dimensions

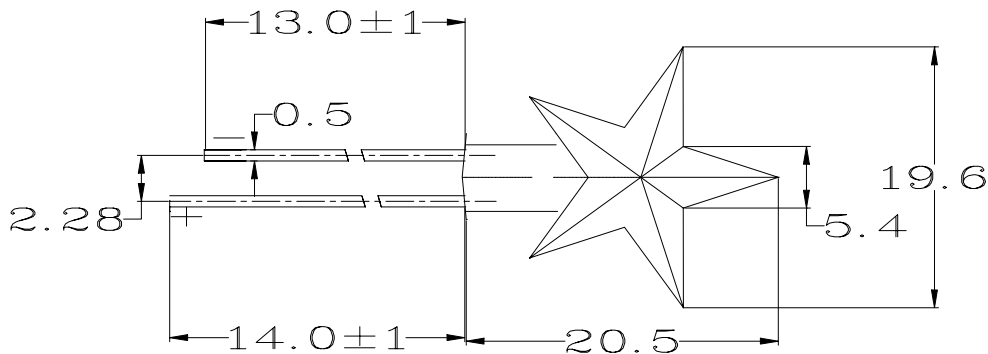

Selection Guide

Part NO.	Lens Type	Chip	IV (mcd)		Viewing Angle
			@10mA	*20mA	
			Min.	Typ.	2 θ 1/2
RL913-RD312C	Bright Red Diffused	GaP/GaP	0.9	1.6	/
RL913-SR112C	Super Red Diffused	GaAlAs/GaAs	42	72	/
RL913-HO312C	Orange Red Diffused	GaAsP/GaP	24	44	/
RL913-HY212C	Yellow Diffused	GaAsP/GaP	13	25	/
RL913-YG412C	Yellow Green Diffused	GaP/GaP	20	36	/
RL913-SO422C	Super Amber Transparent	GaAsP/GaP	31	52	/

1. θ 1/2 is the angle from optical centerline where the luminous intensity is 1/2the optical centerline value.
2. *Luminous intensity with measured at 20mA.



EXCEED PERSEVERANCE ELECTRONIC INDUSTRY CO., LTD.

深圳市超毅光电子有限公司

Electrical/Optical characteristics at TA=25°C.

Symbol	Parameter	Device	Type.	Max.	Units	Test Conditions
λ_{peak}	Peak Wavelength	Bright Red Super Red Orange Red Yellow Yellow Green Super Amber	700 660 630 585 570 610		nm	IF=20mA
λ_D	Dominate Wavelength	Bright Red Super Red Orange Red Yellow Yellow Green Super Amber	690 640 610 580 560 600		nm	IF=20mA
$\Delta \lambda_{1/2}$	Spectral Line Halfwit	Bright Red Super Red Orange Red Yellow Yellow Green Super Amber	45 20 45 35 30 45		nm	IF=20mA
C	Capacitance	Bright Red Super Red Orange Red Yellow Yellow Green Super Amber	40 45 15 20 15 15		pF	VF=0V; f=1MHZ
VF	Forward Voltage	Bright Red Super Red Orange Red Yellow Yellow Green Super Amber	2.1 1.8 2.0 2.0 2.1 2.0	2.8 2.4 2.8 2.8 2.8 2.8	V	IF=20mA
IR	Reverse Current	All		10	uA	VR=5V

Absolute Maximum Ratings at TA=25°C.

Parameter	Bright Red	Super Red	Orange Red	Yellow	Yellow Green	Super Amber	Units
Power dissipation	45	110	100	85	100	100	mW
DC Forward Current	25	25	25	25	25	25	mA
Peak Forward Current	50	200	160	160	160	160	mA
Reverse Voltage	5	5	5	5	5	5	V

NOTES:

1. Operating temperature: 40°C. TO 80°C.
2. Lead soldering: 260°C for 5 seconds.