

Features

- Glass Passivated Die Construction
- Diffused Junction
- Super-Fast Switching for High Efficiency
- High Current Capability and Low Forward Voltage Drop
- Surge Overload Rating to 60A Peak
- Low Reverse Leakage Current
- Plastic Material: UL Flammability Classification Rating 94V-0

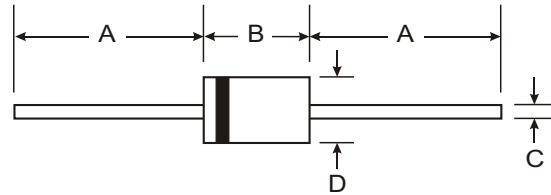

Mechanical Data

- Case: Molded Plastic
- Terminals: Plated Leads Solderable per MIL-STD-202, Method 208
- Polarity: Cathode Band
- Marking: Type Number
- Weight: 0.35 grams (approx.)
- Mounting Position: Any

DO-15		
Dim	Min	Max
A	25.40	—
B	5.50	7.62
C	0.686	0.889
D	2.60	3.6
All Dimensions in mm		

Maximum Ratings and Electrical Characteristics @ T_A = 25°C unless otherwise specified

Single phase, half wave, 60Hz, resistive or inductive load.
For capacitive load, derate current by 20%.

Characteristic	Symbol	SF20 AG	SF20 BG	SF20 CG	SF20 DG	SF20 FG	SF20 GG	SF20 HG	SF20 JG	Unit
Peak Repetitive Reverse Voltage	V _{RRM}	50	100	150	200	300	400	500	600	V
Working Peak Reverse Voltage	V _{RWM}									
DC Blocking Voltage	V _R									
RMS Reverse Voltage	V _{R(RMS)}	35	70	105	140	210	280	350	420	V
Average Rectified Output Current (Note 1)	I _O	2.0								A
Non-Repetitive Peak Forward Surge Current 8.3ms Single half sine-wave Superimposed on Rated Load (JEDEC Method)	I _{FSM}	60								A
Forward Voltage @ I _F = 2.0A	V _{FM}	0.95			1.3		1.5			V
Peak Reverse Current @ T _A = 25°C at Rated DC Blocking Voltage @ T _A = 100°C	I _{RM}	10				100				μA
Reverse Recovery Time (Note 2)	t _{rr}	35			40		50			ns
Typical Junction Capacitance (Note 3)	C _j	75						50		pF
Typical Thermal Resistance Junction to Ambient	R _{θJA}	40								K/W
Operating and Storage Temperature Range	T _j , T _{STG}	-65 to +150								°C

- Notes:
1. Valid provided that leads are kept at ambient temperature at a distance of 9.5mm from the case.
 2. Measured with I_F = 0.5A, I_R = 1.0A, I_{rr} = 0.25A. See Figure 5.
 3. Measured at 1.0MHz and applied reverse voltage of 4.0V DC.

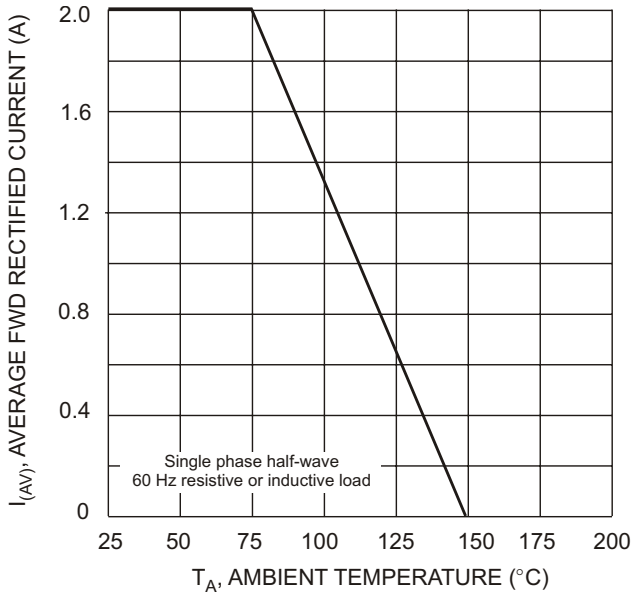

Fig. 1 Forward Current Derating Curve

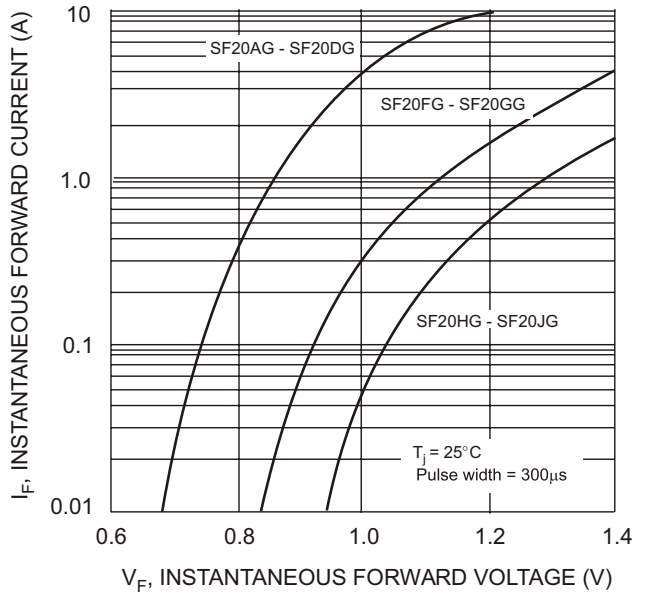

Fig. 2 Typical Forward Characteristics

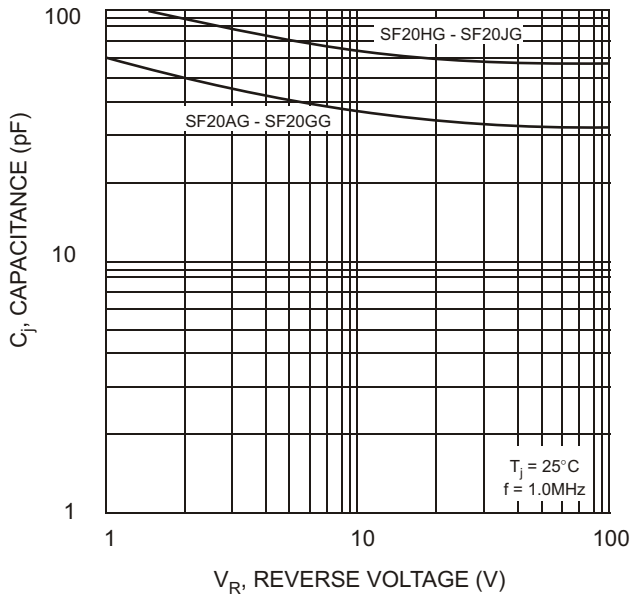

Fig. 4 Typical Junction Capacitance

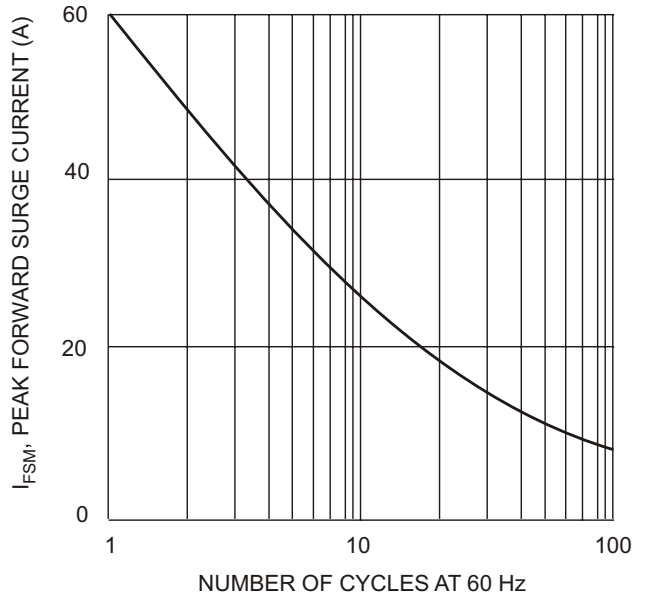
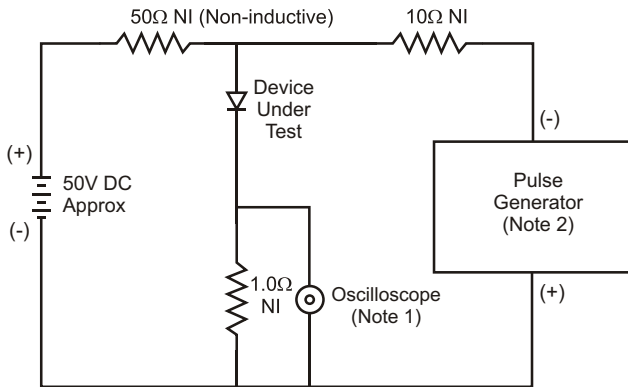
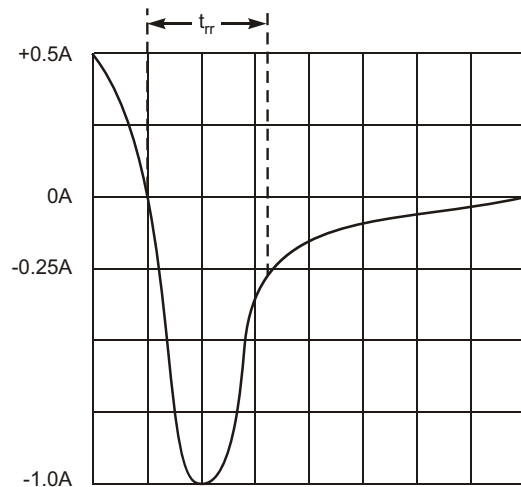

Fig. 3 Peak Forward Surge Current



- Notes:
 1. Rise Time = 7.0ns max. Input Impedance = 1.0MΩ, 22pF.
 2. Rise Time = 10ns max. Input Impedance = 50Ω.



Set time base for 50/100 ns/cm

Fig. 5 Reverse Recovery Time Characteristic and Test Circuit