

Disc Ceramic Capacitors



General Specifications - Class III General Purpose

DIELECTRIC - CLASS III

A thin dielectric layer is grown on a disc of conductive ceramic. Very large capacitances can be obtained due to reduced thickness of this barrier layer and its inherently high dielectric constant. Due its small dimensions, they are a less expensive replacement of multilayer ceramic or polyester capacitors. An equivalent circuit is shown below:

Meets IEC 324 (1970).

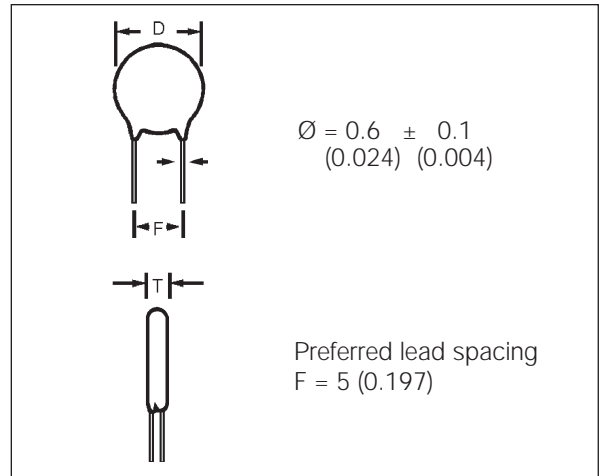

DIMENSIONS

millimeters (inches)

Digit 9 of P.N. (\varnothing)	D \pm 2 (0.079)	T max.	Available Lead Spacing
A	4.0 (0.157)	3.0 (0.118)	A,B,D,E,O,R
B	5.0 (0.197)	3.0 (0.118)	A,B,D,E,O,R,X
C	6.0 (0.236)	3.0 (0.118)	A,B,C,D,E,O,R,X
D	7.0 (0.276)	3.0 (0.118)	A,B,C,D,E,O,R,X
E	8.0 (0.315)	3.0 (0.118)	A,B,C,D,E,O,R,X
F	9.0 (0.354)	3.0 (0.118)	A,B,C,E,O,R,X
G	10.0 (0.394)	3.0 (0.118)	A,B,C,E,O,R,X
H	11.0 (0.433)	3.0 (0.118)	A,B,C,E,O,R,W
J	13.0 (0.512)	3.5 (0.138)	B,C,R,W
K	15.0 (0.591)	4.0 (0.157)	B,C,R,W

millimeters (inches)

Lead Spacing	Digit 8 of P.N.	
F		
2.5 (0.100)	D	—
5 (0.200)	A	O
6 (0.250)	E	X
7.5 (0.300)	B	R
10 (0.400)	C	W

PERFORMANCE CHARACTERISTICS CLASS III

Measured at	1.0 kHz / 0.1 Vrms / 25°C	
Dissipation Factor	$C_R \leq 22 \text{ nF} \rightarrow \text{Y5V, Y5U} \leq 7.5\%$ $C_R > 22 \text{ nF} \rightarrow \text{Y5V, Y5P} \leq 5.0\%$	
Capacitance Tolerance	Y5P $\rightarrow \pm 20\% / -20 + 50\%$ Y5U $\rightarrow \pm 20\% / -20 + 80\%$ Y5V $\rightarrow \pm 20\% / -20 + 80\%$	
Climatic Category	30 / 085 / 21	
Insulation Resistance @ V_R	Y5P	$\geq 12 \text{ M}\Omega$
	Y5U	$4.7 \text{ nF} \dots 100 \text{ nF} \rightarrow \geq 10 \text{ M}\Omega$ $200 \text{ nF} \rightarrow \geq 1 \text{ M}\Omega$
	Y5V	$\geq 100 \text{ M}\Omega$
Dielectric Strength NOTE: Charging current limited to 50 mA	Between leads	$V_t = 1.25 V_R$
	Body insulation	$V_R = 25\text{V } V_t = 100\text{V (DC)}$ $V_R = 50\text{V } V_t = 150\text{V (DC)}$
Operating Temperature Range (°C)	-30... +85	

Note: Damp Heat Steady State: 90... 95% R.H. 40°C / 21 days. No voltage to be applied.

Disc Ceramic Capacitors

Dimension Table

Barrier Layer Capacitors - Class III General Purpose



PHENOLIC COATED – CAPACITANCE VS. DISC DIAMETER

millimeters (inches)

Class III	$\Delta C/C$ (max.) $\pm 12\%$		Range -30... +85°C		$\Delta C/C$ (max.) +30 -65%		Range -30... +85°C		$\Delta C/C$ (max.) +22 -85%		Range -30... +85°C	
Temp. Coefficient	Y5P				Y5U				Y5V			
Digits 1,2,3 of P.N.	5WF		5WH		5YF		5YH		5ZH			
Rated Voltage (V_R)	25 VDC		50 VDC		25 VDC		50 VDC		50 VDC			
C_R (pF)												
4,700	4.0 (0.157)		4.0 (0.157)		4.0 (0.157)		4.0 (0.157)		4.0 (0.157)			
10,000	6.0 (0.236)		6.0 (0.236)									
22,000	7.0 (0.276)		8.0 (0.315)		5.0 (0.197)		6.0 (0.236)					
33,000	8.0 (0.315)		9.0 (0.354)		6.0 (0.236)		7.0 (0.276)					
47,000			11.0 (0.433)									
50,000	10.0 (0.394)		—		7.0 (0.276)		8.0 (0.315)		5.0 (0.197)			
68,000	11.0 (0.433)		13.0 (0.512)									
100,000	13.0 (0.512)		15.0 (0.591)		8.0 (0.315)		9.0 (0.354)		7.0 (0.276)			
200,000	—		—		13.0 (0.512)		—		—			

Y5U, Y5V - Preferences

Diameter (ϕ) = 9th Part Number Digit

Disc Ceramic Capacitors



Ordering Code

HOW TO ORDER

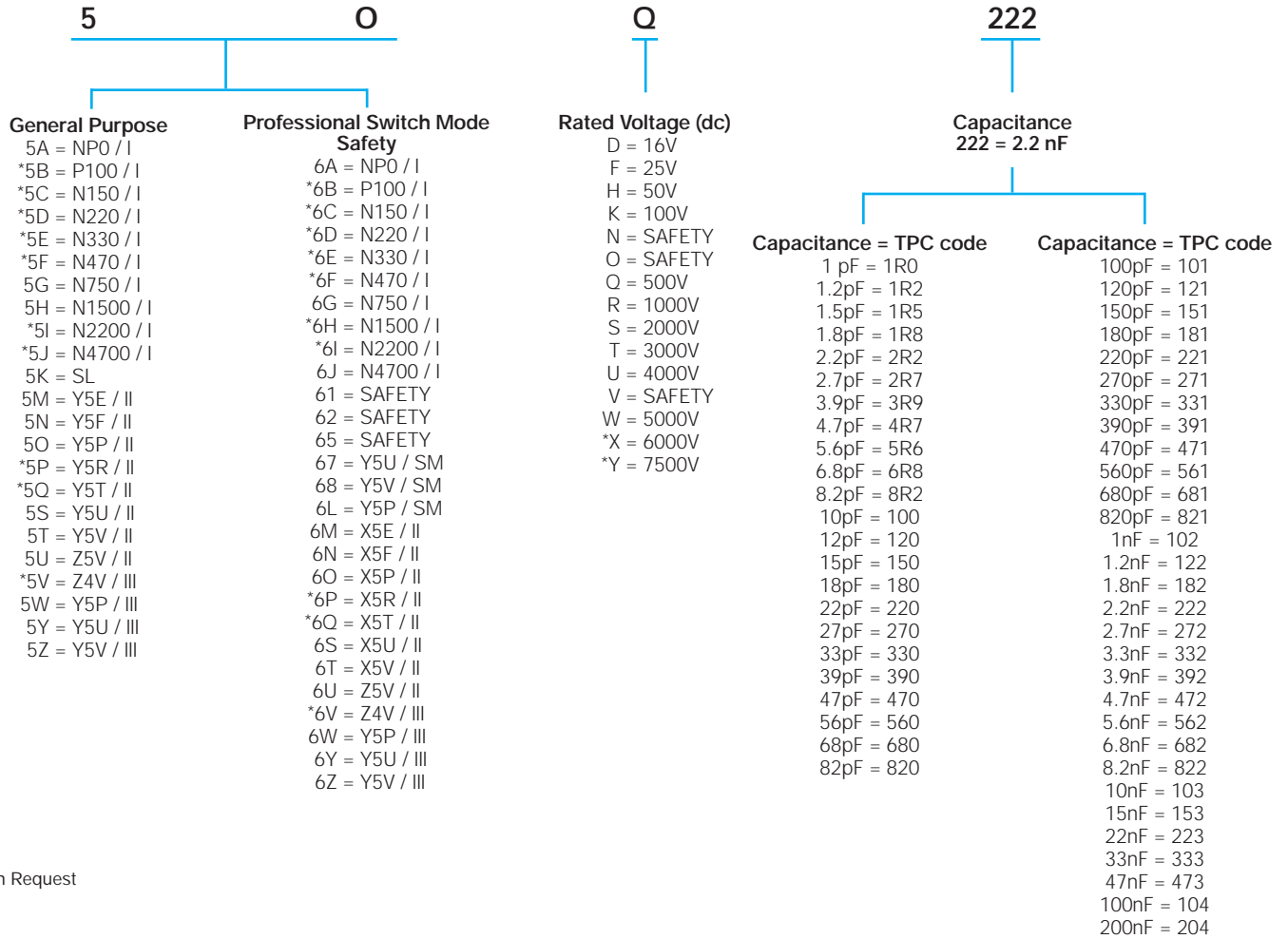

*Upon Request

Disc Ceramic Capacitors



Ordering Code

M

Tolerance
 C = ±0.25 pF
 D = ±0.50 pF
 J = ±5%
 K = ±10%
 M = ±20%
 S = -20+50%
 Z = -20+80%
 P = 0+100%

A

**Capacitor Diameter
 ± 2 (0.079)**
 A = 4 (0.157)
 B = 5 (0.197)
 C = 6 (0.236)
 D = 7 (0.276)
 E = 8 (0.315)
 F = 9 (0.354)
 G = 10 (0.394)
 H = 11 (0.433)
 J = 13 (0.512)
 K = 15 (0.591)
 M* = 19 (0.748)

*Wire 0.8 (0.031) recommended

A

A

Packaging

Cardboard Strips

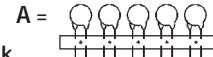

Bulk

E = 5 (0.197) ± 1 (0.039) free wire length
 C = 10 (0.394) ± 1 (0.039) free wire length
 D = 25 (0.984) ± 1 (0.039) free wire length

Taping

Reel



Avisert			Panaset		
H	L	L	J	L	L



Ammo Pack

Avisert			Panaset		
I	M	M	K	M	M

Lead Forming				
mm	inches			
2.5 ±0.5	.1 ± .025	D	-	-
5 ^{+0.6} _{-0.2}	.2 ± .025	A	O	N
6 ^{+0.6} _{-0.2}	.25 ± .025	E	X	-
7.5 ⁺¹ _{-0.5}	.3 ± .05	B	R	Q
10 ^{+0.5} _{-1.0}	.4 ± .05	C	W	-
12.5 ⁺¹ _{-0.5}	.5 ± .05	P	-	-

Finishing

Diam ≤ 9 (0.354) and
 F = 5.00 (0.197)

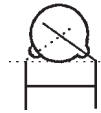

Coating does not surpass the bend

For every other:

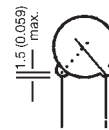

Low Voltage

A = Phenolic (General Purpose) Q = Waxed phenolic

S = Epoxy (Professional) cap. diameter ≤ 8 (0.315)

D = Epoxy (Professional) cap. diameter > 8 (0.315)

High Voltage

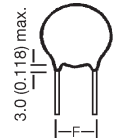

F = Measured from the center of leads

C = Epoxy wire diameter 0.6 ± 0.1 (0.024) ± (0.004)

I = Epoxy wire diameter 0.8 ± 0.1 (0.031) ± (0.004)

L = Phenolic wire diameter 0.6 ± 0.1 (0.024) ± (0.004)

Please note that not all code combinations are either possible or available.

Disc Ceramic Capacitors



Marking

DIG. 2		Logo: Only in diam. ≥ 6mm	Capacitance		EIA	
O				1pF = 109	100pF = 101	
TC / Class		1.2pF = 129		120pF = 121		
General Purpose	Professional	1.5pF = 159		150pF = 151		
A = NP0 / I	A = NP0 / I	1.8pF = 189		180pF = 181		
*B = P100 / I	B = P100 / I	2.2pF = 229		220pF = 221		
*C = N150 / I	C = N150 / I	2.7pF = 279		270pF = 271		
*D = N220 / I	D = N220 / I	3.9pF = 399		390pF = 391		
*E = N330 / I	E = N330 / I	4.7pF = 479		470pF = 471		
*F = N470 / I	F = N470 / I	5.6pF = 569		560pF = 561		
G = N750 / I	G = N750 / I	6.8pF = 689		680pF = 681		
H = N1500 / I	H = N1500 / I	8.2pF = 829	820pF = 821			
*I = N2200 / I	I = N2200 / I	10pF = 100	1nF = 102			
*J = N4700 / I	J = N4700 / I	12pF = 120	1.2nF = 122			
K = SL	7 = Y5U / SM	15pF = 150	1.8nF = 182			
M = Y5E / II	8 = Y5V / SM	18pF = 180	2.2nF = 222			
N = Y5F / II	L = Y5P / SM	22pF = 220	2.7nF = 272			
O = Y5P / II	M = X5E / II	27pF = 270	3.9nF = 392			
P = Y5R / II	N = X5F / II	39pF = 390	4.7nF = 472			
Q = Y5T / II	O = X5P / II	47pF = 470	5.6nF = 562			
S = Y5U / II	P = X5R / II	56pF = 560	6.8nF = 682			
T = Y5V / II	Q = X5T / II	68pF = 680	8.2nF = 822			
U = Z5V / II	S = X5U / II	82pF = 820	10nF = 103			
V = Z4V / III	T = X5V / II		15nF = 153			
*W = Y5P / II	U = Z5V / II		22nF = 223			
*X = Y5R / II	V = Z4V / III		33nF = 333			
Y = Y5U / II	W = Y5P / III		47nF = 473			
Z = Y5V / II	X = Y5R / III		100nF = 104			
	Y = Y5U / III		200nF = 204			
	Z = Y5V / III					

*Upon Request

DIG. 3	DIG. 7
Q	M
Rated Voltage	Tolerance
D = 16V	C = ±0.25pF
F = 25V	D = ±0.5pF
H = 50V	J = ±5%
K = 100V	K = ±10%
Q = 500V	M = ±20%
R = 1000V	S = -20 +50%
S = 2000V	Z = -20 +80%
T = 3000V	P = 0 +100%
U = 4000V	
W = 5000V	
X = 6000V	
Y = 7500V	

Safety Front	Type		
<table border="1"> <tr> <th>Capacitance</th> </tr> <tr> <td>As above</td> </tr> </table>	Capacitance	As above	61V
	Capacitance		
	As above		
620			
65N			
<table border="1"> <tr> <th>Tolerance</th> </tr> <tr> <td>As above</td> </tr> </table>	Tolerance	As above	
	Tolerance		
As above			

Back: (Approval marks)

TC – Temperature coefficient.

DIG – for better understanding, check pages 3 and 4.

IDENTIFICATION AND TRACEABILITY

On all TPC ceramic capacitors packages, you will find a bar code label with the following information:

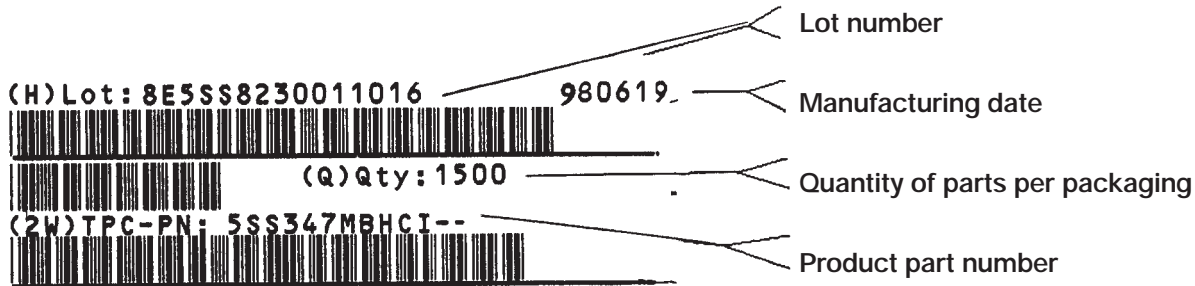

TAPED PARTS QUANTITY TABLE

millimeters (inches)

Rated Voltage (Vr)	Diameter D	Quantities	
		Ammopack	Reel
Vr ≤ 500V	D ≤ 7 (0.276)	2000	2500
	7 < D ≤ 11 (0.433)	2000	2000
500V < Vr ≤ 2KV	D ≤ 11 (0.433)	1500	2000
2KV < Vr = 5KV	D ≤ 11 (0.433)	1000	1500

CARDBOARD STRIPS QUANTITY TABLE

millimeters (inches)

Rated Voltage (Vr)	Diameter D	Lead Space	
		< = 5 (0.197)	> 5 (0.197)
Vr ≤ 500V	D ≤ 8 (0.315)	2500	1500
	8 (0.315) ≤ D ≤ 11 (0.433)	1500	-
	8 (0.315) ≤ D ≤ 13 (0.512)	-	1000
	11 (0.433) ≤ D ≤ 15 (0.591)	1000	-
	13 (0.512) ≤ D ≤ 19 (0.748)	-	500
	D ≤ 19 (0.748)	500	-
500V < Vr ≤ 2KV	D ≤ 9 (0.354)	1500	1000
	9 (0.354) ≤ D ≤ 11 (0.433)	-	1000
	9 (0.354) ≤ D ≤ 13 (0.512)	1000	-
	11 (0.433) ≤ D ≤ 19 (0.748)	-	500
	13 (0.512) ≤ D ≤ 19 (0.748)	500	-
2KV < Vr = 5KV Safety 65N 62O	D ≤ 9 (0.354)	1500	-
	D ≤ 11 (0.433)	-	1000
	D ≤ 13 (0.512)	500	500
Safety 61V	D ≤ 6 (0.236)	1500	1500
	7 (0.275) ≤ D ≤ 9 (0.354)	1000	1000
	9 (0.354) ≤ D	500	500

Quantities for other package alternative, upon request.

Disc Ceramic Capacitors



Tape and Reel Specifications

There are two types of taped disc ceramic capacitors:
Straight or crimped leads.

Both types can be shipped on reels or ammopack.
The standard packaging quantities are shown below:

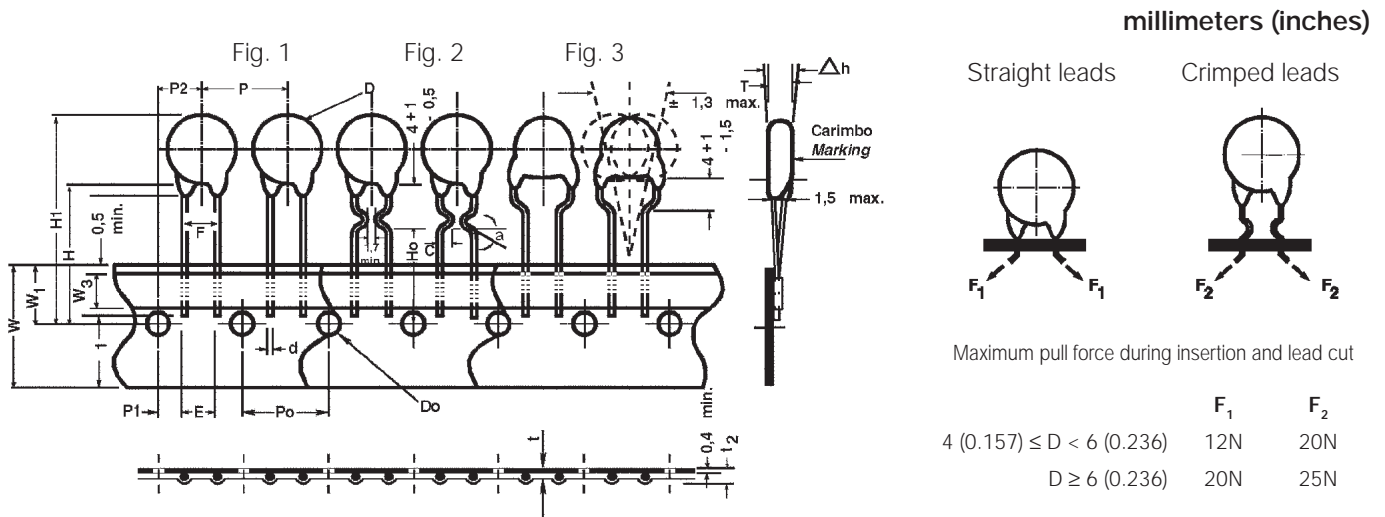

Digit 11	Available Tapings	Digit 9
L	➔	Sizes 4 (0.157) ≤ D ≤ 11 (0.433) A... H
M		
J H	➔	Sizes 6 (0.236) ≤ D ≤ 11 (0.433) C... H
K I		

TPC Code Digit 11











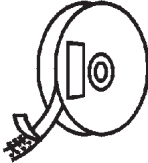

Packaging	Avisert	Panasert
Reel 	 H FIGURE 1  L FIGURE 2  L FIGURE 3	 J FIGURE 1  L FIGURE 2  L FIGURE 3
Ammopack 	 I FIGURE 1  M FIGURE 2  M FIGURE 3	 K FIGURE 1  M FIGURE 2  M FIGURE 3

Figure 2: Inside Crimp 100V... 1000V

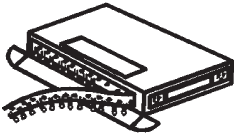
Figure 3: Outside Crimp 1000V

Disc Ceramic Capacitors



Tape and Reel Specifications

millimeters (inches)

Description of Symbols		Straight Leads		Crimped
		Figure 1		Figure 2 & 3
		A (Avisert)	P (Panaset)	Avisert & Panaset
Crimp angle	∞	—	—	20°...45°
Crimp length	C	—	—	1.7 min.
Lead diameter	d	0.60 ± 0.1		
Disc diameter	D	11 max.		
Lead hole diameter	Do	4.0 ± 0.2		
Disc thickness	T	See Catalog		
Lead spacing	F	5.0 $^{+0.6}_{-0.2}$		
Component alignment, front-rear	Δh	0 ± 1		
Height of component from tape center	H	19.5 ± 0.5	16.5 ± 0.5 - 0	—
Height from tape center to crimp	Ho	—	—	16 + 0.5 - 0
Component height	H1	32.25 max.	>23.5 <32.25	32.25 max.
Distance from component leads to tape bottom	ℓ_1	12 max.		
Tape width	W	18 $^{+1}_{-0.5}$		
Bonding tape width	W ₃	5.5 min.		
Feed hole position	W ₁	9.0 ± 0.5		
Pitch between discs	P	12.7 ± 1		
Feed hole pitch	Po	12.7 ± 0.3		
Hole center to lead	P1	3.85 ± 0.7		
Feed hole center to component center	P2	6.35 ± 1		
Tape + bonding tape thickness	t	0.7 ± 0.2		
Total tape thickness, including lead	t ₂	1.5 max.		

PACKAGING

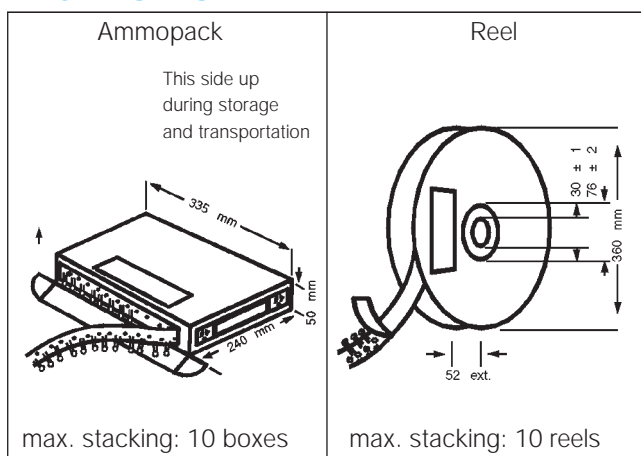

SHIPPING CONTAINER

