



Model 9003, 9004, 9009, 9010, & 9011 Manual Step Attenuators

dc to 18.0 GHz
2 Watt

Ruggedized SMA Connector



Features

- /// **Broadband** - Available in a choice of frequency ranges: dc to 4, dc to 8, dc to 12.4 and dc to 18 GHz.
- /// **Wide Choice of Attenuation Ranges** - A choice of five standard attenuation ranges is available: 0 to 9.0, 0 to 69 and 0 to 99 dB in 1 dB steps, and 0 to 60 and 0 to 90 dB in 10 dB steps.
- /// **Environmental** - Designed to meet most environmental requirements of MIL-A-24215 (Vibration, Shock, Relative Humidity to 95% and Altitude).
- /// **In-line Configuration** - Passivated stainless steel SMA connector are set parallel with control shaft (except units with right angle connector) to reduce volume for applications where space is critical. All models are bidirectional.
- /// **Precise Incremental Attenuation Accuracy** - Model 9000 series has flat frequency response and small deviation from nominal attenuation at all settings (e.g., deviation is only ± 2.5 dB at 99 dB setting at 18 GHz).
- /// **Excellent Repeatability and Long Switch Life.**
- /// **Custom Configurations Available Upon Request.**
- /// **Highly Accurate Detent Stepping** - Direct drive of attenuator drums eliminates gears and provides for excellent repeatability.
- /// **Safety Mechanical Stop** - A mechanical stop between maximum and 0 attenuation positions on all models except 0-9 dB unit is provided to prevent large power changes at attenuator output from damaging sensitive equipment.

Description

The Model 9000 series Step Attenuators are broadband miniature step attenuators that provide excellent performance characteristics suitable for use in high reliability 50 ohm systems and applications requiring extra-small components for the precision control of signal levels. The Model 9000 series can be used either as input or output attenuators in signal sources, receivers, field strength meters, spectrum analyzers, etc.

The SMA connector furnished on all models are available in either standard or right-angle configuration. The sex of front and rear connector is optional (refer to connector specification for specific combinations available). A knob(s), marked appropriately, is supplied with each unit.

Specifications

NOMINAL IMPEDANCE: 50 Ω

FREQUENCY RANGE (add Model No. Prefix to Designate Range):

All Models: dc to 4.0 GHz (AC)
 dc to 18.0 GHz (AF)

Standard Incremental Attenuation Range:

Model 9009: 0 to 9 dB in 1 dB steps
Model 9003: 0 to 69 dB in 1 dB steps
Model 9004: 0 to 99 dB in 1 dB steps
Model 9010: 0 to 60 dB in 10 dB steps
Model 9011: 0 to 90 dB in 10 dB steps

MAXIMUM SWR:

Frequency Range (GHz)	9009, 9010 9011	9003 9004
dc - 4	1.25	1.35
dc - 18	1.60	1.75

POWER RATING: 2 watts **average** to 25°C ambient temperature, derated linearly to 1 watt @ 54°C. 200 watts **peak** (5 μ sec pulse width; 0.5% duty cycle)

POWER COEFFICIENT: < 0.005dB/dB/watt

TEMPERATURE COEFFICIENT: < 0.0004 dB/dB/°C

TEMPERATURE RANGE:

Operating: 0°C to + 54°C
Nonoperating: -54°C to +54°C



Specifications--con't

CALIBRATION: Insertion Loss data is supplied as follows. Other test data can be supplied at additional cost.

- dc to 4 GHz: At 50 MHz and 4 GHz
- dc to 18 GHz: At 50 MHz, 4, 8, 12 and 18 GHz

INCREMENTAL PHASE SHIFT: ~0.5° per dB per GHz

REPEATABILITY: Better than 0.05 dB across frequency band for switch life

SWITCH LIFE: Over 1,000,000 steps

SHAFT ROTATION: Clockwise for increasing attenuation.

CONSTRUCTION:

- Drum Assembly: Aluminum alloy
- Housing: Phenolic or aluminum
- Control Shaft: Stainless steel
- Connector: Stainless steel
- Knob: Supplied with control knob

INDEXING: 36°

DRUM CONFIGURATIONS:

- Single Drum: 9009, 9010, 9011
- Dual Drum: 9003, 9004

MAXIMUM INSERTION LOSS (dB):

Frequency Range (GHz)	Model No.				
	9009	9003	9004	9010	9011
dc - 4	0.3	0.6	0.6	0.4	0.5
4 - 8	0.5	0.8	0.8	0.5	0.6
8 - 12.4	0.7	1.0	1.0	0.7	0.7
12.4 - 18	1.0	1.5	1.5	1.0	1.0

CONNECTOR: SMA connector per MIL-STD-348 interface dimensions - mate nondestructively with MIL-C-39012 connector. Front and rear SMA connector available in either standard or right-angle configuration, connector sex is optional as follows:

Connector Options	Type/Description
1	SMA, Female
2	SMA, Male*
3	SMA, Female, right-angle
4	SMA, Male, right-angle

*Standard male SMA connector not available as J1 connector.

WEIGHT:

9009	680 g (2.4 oz)
9010	160 g (5.7 oz)
9011	200 g (7.1 oz)
9003	260 g (9.0 oz)
9004	290 g (10.4 oz)

INCREMENTAL INSERTION LOSS (±dB):

Model Number	dB Range	Frequency Range (GHz)	
		dc-4	dc-18
9009	1-9	0.3	0.5
9003	1-9	0.3	0.5
	10-19	0.7	1.0
	20-29	0.9	1.2
	30-39	1.0	1.4
	40-49	1.1	1.5
	50-59	1.2	1.7
9004	60-69	1.3	1.9
	1-9	0.3	0.5
	10-19	0.7	1.0
	20-29	0.9	1.2
	30-39	1.0	1.4
	40-49	1.1	1.5
9010	50-59	1.2	1.7
	60-69	1.3	1.9
	70-79	1.4	2.1
	80-89	1.5	2.3
	90-99	1.6	2.5
	9011	10	0.3
20		0.3	1.0
30		0.4	1.0
40		0.5	1.2
50		0.7	1.5
60		0.8	1.8
9011	70	0.9	2.1
	80	1.0	2.3
	90	1.2	2.5

NA=Model no longer available.

MODEL NUMBER DESCRIPTION:

Example:

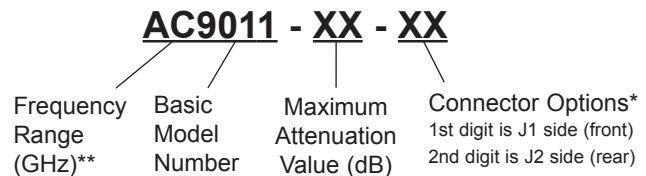

** Frequency Range

- dc-4.0 GHz (AC)
- dc-8.0 GHz (AD)
- dc-12.4 GHz (AE)
- dc-18.0 GHz (AF)

Available Models

- AC9003, AC9004, AC9009, AC9010, AC9011
- No longer available, order AF as replacement
- No longer available, order AF as replacement
- AF9003, AF9004, AF9009, AF9010, AF9011



PHYSICAL DIMENSIONS:

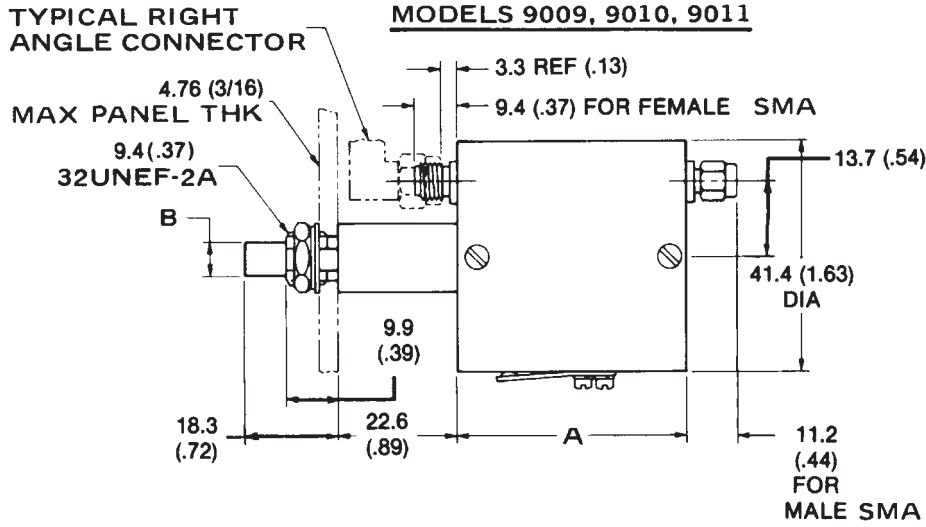

MOUNTING HOLE

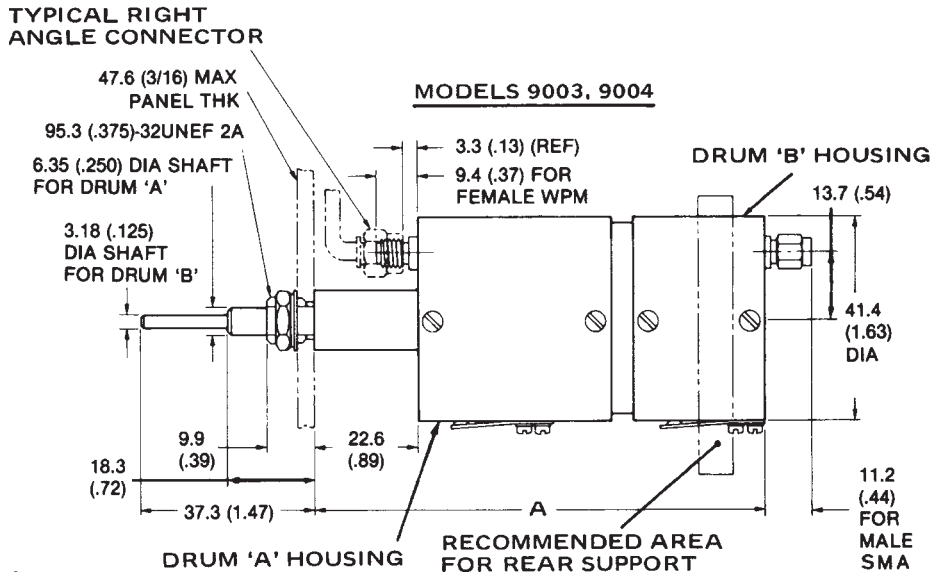
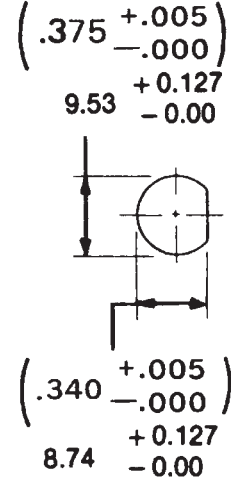

RIGHT ANGLE FEMALE SMA

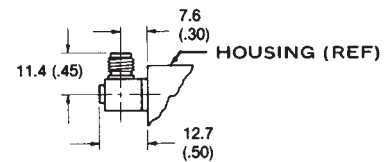

RIGHT ANGLE MALE SMA

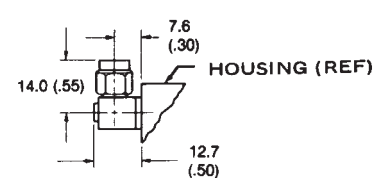

Model No.	DIM A	DIM B
9003	96.3 (3.79)	---
9004	106.4 (4.19)	---
9009	28.7 (1.13)	3.25 (0.125)
9010	41.4 (1.63)	6.35 (0.250)
9011	51.6 (2.03)	6.35 (0.250)

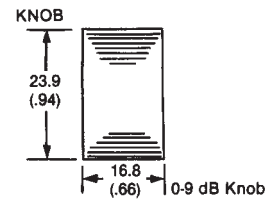
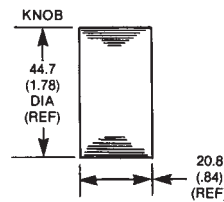

NOTE: All dimensions are given in mm (inches) and are maximum, unless otherwise specified.