

TS802C04 (10A)

(40V / 10A)

SCHOTTKY BARRIER DIODE

Outline drawings, mm

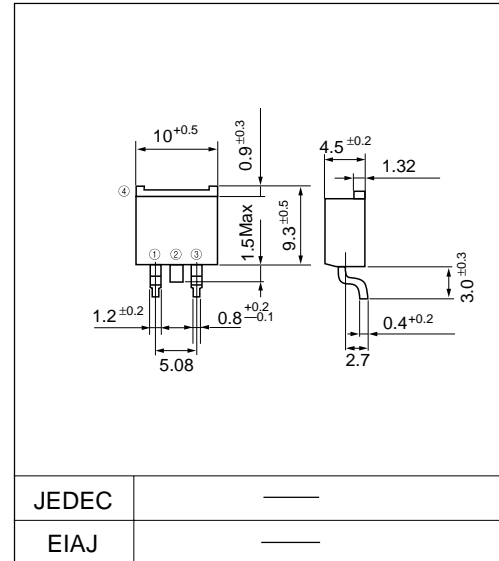

Features

- Low V_F
- Super high speed switching
- High reliability by planer design

Applications

- High speed power switching

Connection diagram

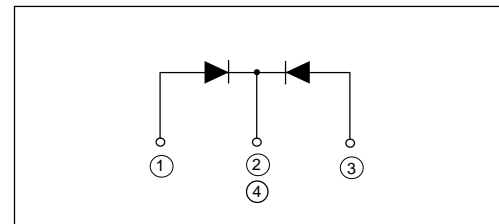

Maximum ratings and characteristics

- Absolute maximum ratings

Item	Symbol	Conditions	Rating	Unit
Repetitive peak reverse voltage	V_{RRM}		40	V
Non-repetitive peak reverse voltage	V_{RSM}	$t_w=500\text{ns}$, $\text{duty}=1/40$	48	V
Average output current	I_o	Square wave, $\text{duty}=1/2$ $T_c=116^\circ\text{C}$	10*	A
Surge current	I_{FSM}	Sine wave 10ms	120	A
Operating junction temperature	T_j		-40 to +150	$^\circ\text{C}$
Storage temperature	T_{stg}		-40 to +150	$^\circ\text{C}$

* Average forward current of centertap full wave connection

- Electrical characteristics ($T_a=25^\circ\text{C}$ Unless otherwise specified)

Item	Symbol	Conditions	Max.	Unit
Forward voltage drop	V_{FM}	$I_{FM}=4.0\text{A}$	0.55	V
Reverse current	I_{RRM}	$V_R=V_{RRM}$	5.0	mA
Thermal resistance	$R_{th(j-c)}$	Junction to case	3.0	$^\circ\text{C}/\text{W}$

■ Characteristics

Forward Characteristic (typ.)

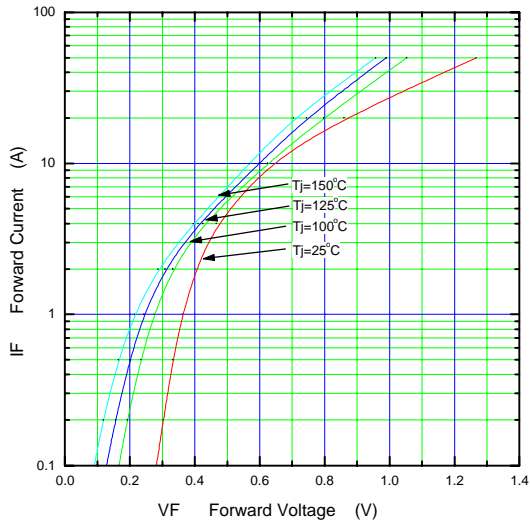

Reverse Characteristic (typ.)

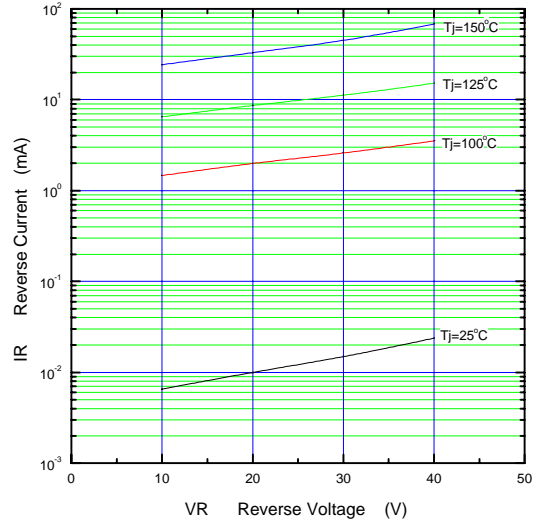

Forward Power Dissipation

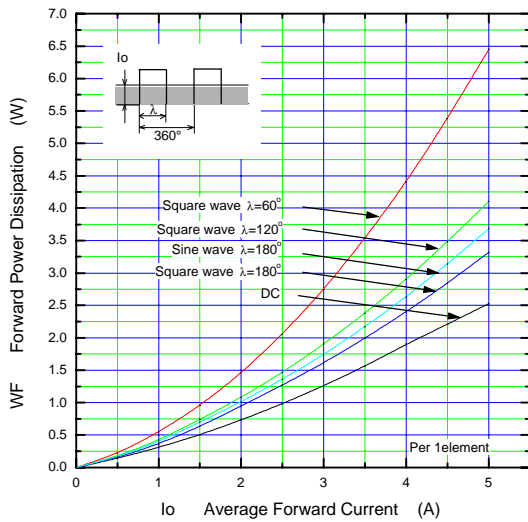

Reverse Power Dissipation

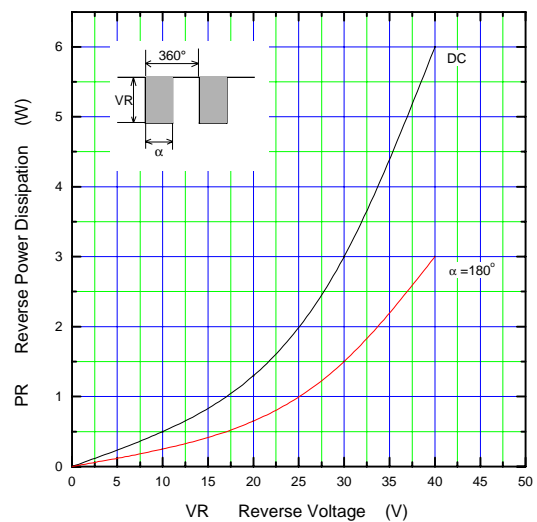

Current Derating (I_o-T_c)

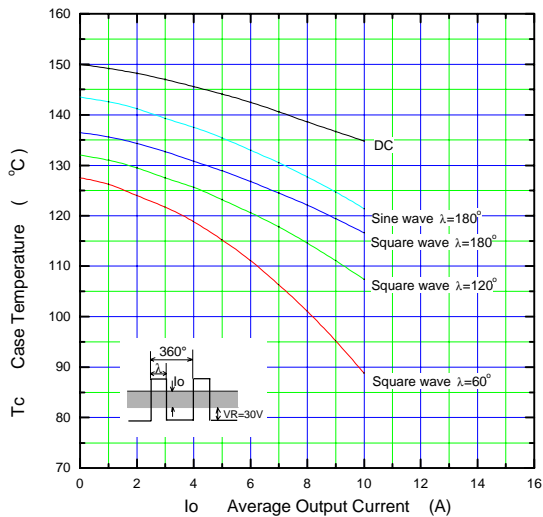

Junction Capacitance Characteristic (typ.)

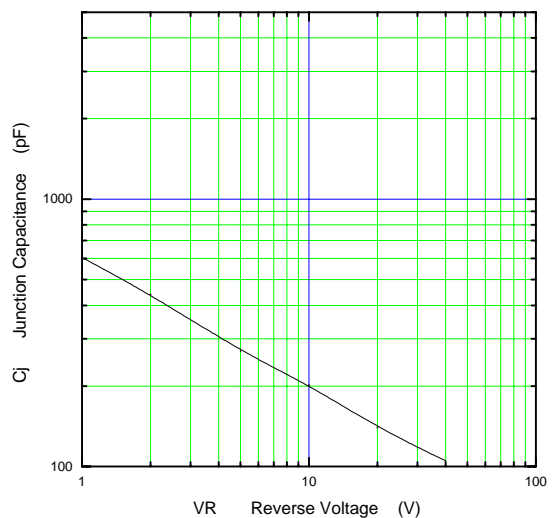

λ :Conduction angle of forward current for each rectifier element
I_o:Output current of center-tap full wave connection

