

# Hyper 5 mm (T1 ¾) LED, Non Diffused Hyper-Bright LED

LS 5426, LO 5426, LY 5426, LA 5416



## Besondere Merkmale

- **Gehäusetypp:** klares 5 mm (T1 ¾) Gehäuse; eingefärbt (super-rot, orange, gelb), farblos (amber)
- **Besonderheit des Bauteils:** enge Abstrahlcharakteristik
- **Wellenlänge:** 632 nm (super-rot), 615 nm (amber), 605 nm (orange), 587 nm (gelb)
- **Abstrahlwinkel:** 16°
- **Technologie:** InGaAlP
- **optischer Wirkungsgrad:** 11 lm/W (gelb, orange, amber), 7 lm/W (super-rot)
- **Gruppierungsparameter:** Lichtstärke
- **Lötmethode:** Wellenlöten (TTW)
- **Verpackung:** Schüttgut, gegurtet lieferbar

## Anwendungen

- optischer Indikator
- Ampelanwendung
- Verkehrsinformationssysteme
- Innenbeleuchtung im Automobilbereich (z.B. Instrumentenbeleuchtung, u.ä.)
- Ersatz von Kleinst-Glühlampen
- Markierungsbeleuchtung (z.B. Stufen, Fluchtwege, u.ä.)
- Signal- und Symbolleuchten
- Hinterleuchtung (Tasten, Displays, Werbebeleuchtung, Allgemeinbeleuchtung)

## Features

- **package:** clear 5 mm (T1 ¾) package; colored (super-red, orange, yellow), colorless (amber)
- **feature of the device:** narrow viewing angle
- **wavelength:** 632 nm (super-red), 615 nm (amber), 605 nm (orange), 587 nm (yellow)
- **viewing angle:** 16°
- **technology:** InGaAlP
- **optical efficiency:** 11 lm/W (yellow, orange, amber), 7 lm/W (super-red)
- **grouping parameter:** luminous intensity
- **soldering methods:** TTW soldering
- **packing:** bulk, available taped on reel

## Applications

- optical indicators
- traffic lights
- traffic information displays
- interior automotive lighting (e.g. dashboard backlighting, etc.)
- substitution of micro incandescent lamps
- marker lights (e.g. steps, exit ways, etc.)
- signal and symbol luminaire
- backlighting (keys, displays, illuminated advertising, general lighting)

Typ Type	Emissions- farbe Color of Emission	Gehäuse- farbe Color of Package	Lichtstärke Luminous Intensity $I_F = 20 \text{ mA}$ $I_V \text{ (mcd)}$	Lichtstrom Luminous Flux $I_F = 20 \text{ mA}$ $\Phi_V \text{ (mlm)}$	Bestellnummer Ordering Code
LS 5426-TV LS 5426-VBW	super-red	red clear	280 ... 1120 710 ... 2800	240 (typ.) 380 (typ.)	on request on request
LO 5426-VAW LO 5426-AWCW	orange	orange clear	710 ... 1800 1120 ... 4500	340 (typ.) 450 (typ.)	on request on request
LY 5426-VAW LY 5426-AWCW	yellow	yellow clear	710 ... 1800 1120 ... 4500	340 (typ.) 450 (typ.)	on request on request
LA 5416-VAW LA 5416-AWCW	amber	colorless clear	710 ... 1800 1120 ... 4500	340 (typ.) 450 (typ.)	on request on request

*Anm.: Die Standardlieferform von Serientypen beinhaltet eine untere bzw. eine obere Familiengruppe oder mindestens zwei Einzelgruppen.*

*In einer Verpackungseinheit / Gurt ist immer nur eine Helligkeitsgruppe enthalten.*

*Die technologiebedingte Helligkeits-Streuung der heutigen LED-Herstellprozesse über einen längeren Fertigungszeitraum (Halbleitermaterial - Chipherstellung - Montageprozess) erlaubt keine Zusage einer einzelnen Helligkeitsgruppe. Daher müssen mindestens zwei Helligkeitsgruppen vorgesehen werden!*

*Note: The standard shipping format for serial types includes a lower or upper family group or at least two individual groups.*

*No packing unit / tape ever contains more than one luminous intensity group.*

*Luminosity variations caused by the technology used in current LED manufacturing processes over a protracted manufacturing period (semiconductor material - chip fabrication - assembly process) mean that it is not possible to assign LEDs to a single luminous intensity group. For this reason at least two luminous intensity groups must be provided!*

**Grenzwerte**  
**Maximum Ratings**

Bezeichnung Parameter	Symbol Symbol	Werte Values		Einheit Unit
		LS, LO, LA	LY	
Betriebstemperatur Operating temperature range	$T_{op}$	- 55 ... + 100		°C
Lagertemperatur Storage temperature range	$T_{stg}$	- 55 ... + 100		°C
Sperrschichttemperatur Junction temperature	$T_j$	+ 100		°C
Durchlassstrom Forward current	$I_F$	30		mA
Stoßstrom Surge current $t \leq 10 \mu s, D = 0.005$	$I_{FM}$	1	0.2	A
Sperrspannung Reverse voltage	$V_R$	3		V
Leistungsaufnahme Power consumption $T_A \leq 25 \text{ °C}$	$P_{tot}$	80		mW
Wärmewiderstand Thermal resistance Sperrschicht/Umgebung Junction/ambient	$R_{th JA}$	500		K/W
Sperrschicht/Löt看 Junction/solder point Montage auf PC-Board FR 4 (Padgröße $\geq 16 \text{ mm}^2$ ) mounted on PC board FR 4 (pad size $\geq 16 \text{ mm}^2$ ) Minimale Beinchenlänge Minimum lead length	$R_{th JS}$	280		K/W

**Kennwerte** ( $T_A = 25\text{ °C}$ )

**Characteristics**

Bezeichnung Parameter	Symbol Symbol	Werte Values				Einheit Unit
		LS	LA	LO	LY	
Wellenlänge des emittierten Lichtes (typ.) Wavelength at peak emission $I_F = 20\text{ mA}$	$\lambda_{\text{peak}}$	645	622	610	591	nm
Dominantwellenlänge (typ.) Dominant wavelength $I_F = 20\text{ mA}$	$\lambda_{\text{dom}}$	632	615	605	587	nm
Spektrale Bandbreite bei 50 % $I_{\text{rel max}}$ (typ.) Spectral bandwidth at 50 % $I_{\text{rel max}}$ $I_F = 20\text{ mA}$	$\Delta\lambda$	16	16	16	15	nm
Abstrahlwinkel bei 50 % $I_V$ (Vollwinkel) (typ.) Viewing angle at 50 % $I_V$	$2\phi$	16	16	16	16	Grad deg.
Durchlassspannung <sup>1)</sup> (typ.) Forward voltage (max.) $I_F = 20\text{ mA}$	$V_F$ $V_F$	2.0 2.4	2.0 2.4	2.0 2.4	2.0 2.4	V V
Sperrstrom (typ.) Reverse current (max.) $V_R = 3\text{ V}$	$I_R$ $I_R$	0.01 10	0.01 10	0.01 10	0.01 10	$\mu\text{A}$ $\mu\text{A}$
Temperaturkoeffizient von $\lambda_{\text{peak}}$ (typ.) Temperature coefficient of $\lambda_{\text{peak}}$ $I_F = 20\text{ mA}; -10\text{ °C} \leq T \leq 100\text{ °C}$	$TC_{\lambda_{\text{peak}}}$	0.14	0.13	0.13	0.13	nm/K
Temperaturkoeffizient von $\lambda_{\text{dom}}$ (typ.) Temperature coefficient of $\lambda_{\text{dom}}$ $I_F = 20\text{ mA}; -10\text{ °C} \leq T \leq 100\text{ °C}$	$TC_{\lambda_{\text{dom}}}$	0.01	0.06	0.07	0.10	nm/K
Temperaturkoeffizient von $V_F$ (typ.) Temperature coefficient of $V_F$ $I_F = 20\text{ mA}; -10\text{ °C} \leq T \leq 100\text{ °C}$	$TC_V$	-2.0	-1.8	-1.7	-2.5	mV/K
Optischer Wirkungsgrad (typ.) Optical efficiency $I_F = 20\text{ mA}$	$\eta_{\text{opt}}$	7	11	11	11	lm/W

<sup>1)</sup> Spannungswerte werden mit einer Stromeinprägedauer von 1 ms und einer Genauigkeit von  $\pm 0.1\text{ V}$  ermittelt.  
Voltages are tested at a current pulse duration of 1 ms and a tolerance of  $\pm 0.1\text{ V}$ .

**Helligkeits-Gruppierungsschema**  
**Luminous Intensity Groups**

<b>Lichtgruppe</b> <b>Luminous Intensity Group</b>	<b>Lichtstärke</b> <b>Luminous Intensity</b> <b><math>I_v</math> (mcd)</b>	<b>Lichtstrom</b> <b>Luminous Flux</b> <b><math>\Phi_v</math> (mlm)</b>
T	280 ... 450	180 (typ.)
U	450 ... 710	240 (typ.)
V	710 ... 1120	300 (typ.)
AW	1120 ... 1800	380 (typ.)
BW	1800 ... 2800	450 (typ.)
CW	2800 ... 4500	580 (typ.)

Helligkeitswerte werden mit einer Stromeinprägedauer von 25 ms und einer Genauigkeit von  $\pm 11\%$  ermittelt.  
 Luminous intensity is tested at a current pulse duration of 25 ms and a tolerance of  $\pm 11\%$ .

Relative spektrale Emission  $I_{rel} = f(\lambda)$ ,  $T_A = 25\text{ °C}$ ,  $I_F = 20\text{ mA}$

**Relative Spectral Emission**

$V(\lambda)$  = spektrale Augenempfindlichkeit

Standard eye response curve

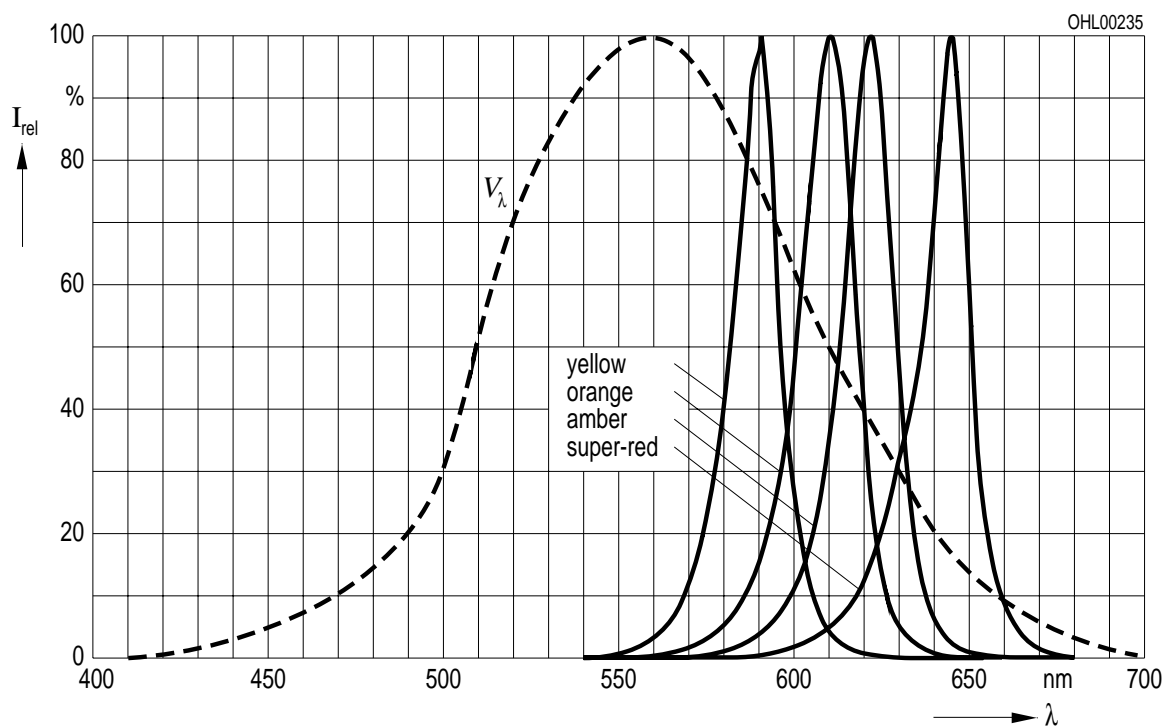

Abstrahlcharakteristik  $I_{rel} = f(\varphi)$

**Radiation Characteristic**

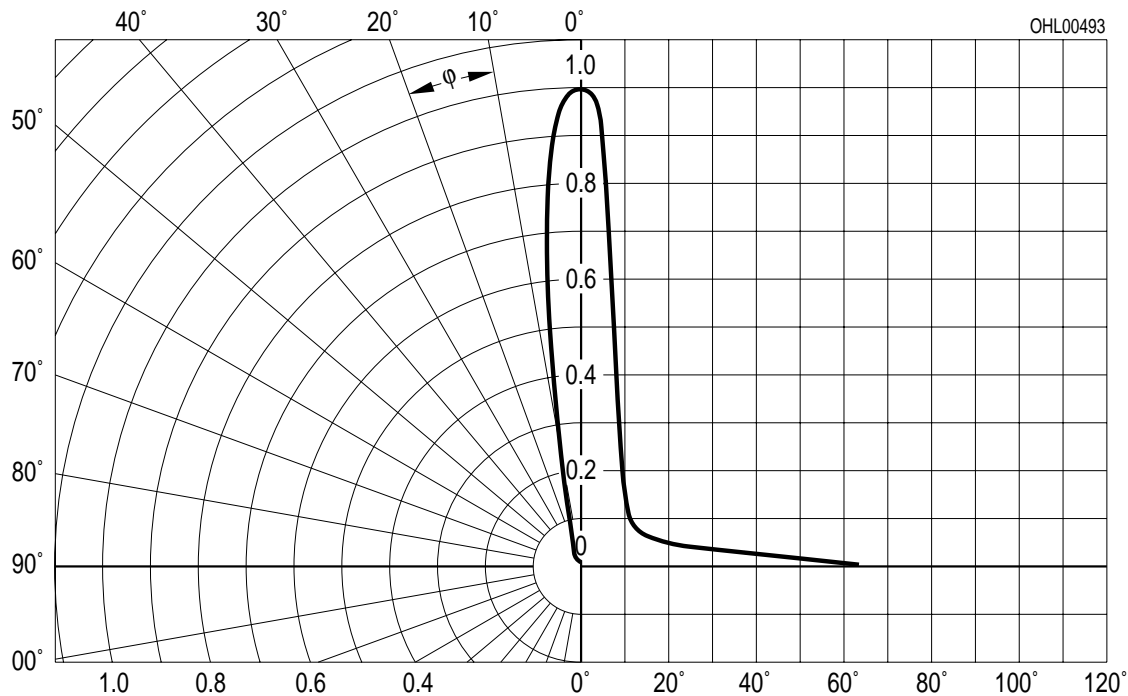

**Durchlassstrom  $I_F = f(V_F)$**   
**Forward Current**

$T_A = 25\text{ °C}$

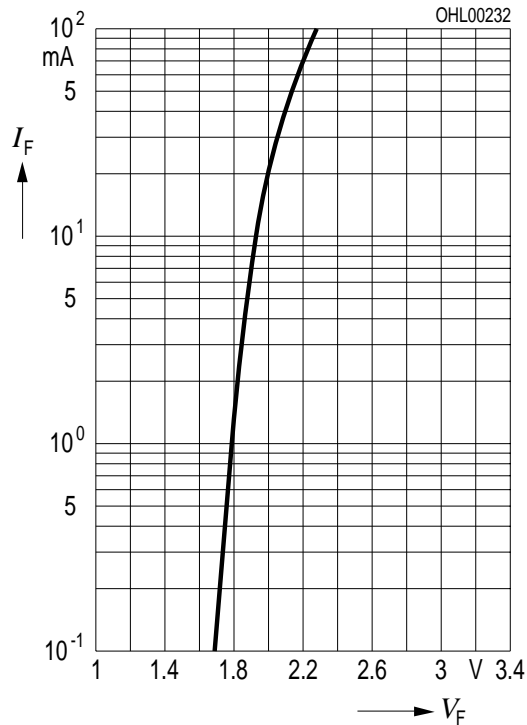

**Relative Lichtstärke  $I_V/I_{V(20\text{ mA})} = f(I_F)$**   
**Relative Luminous Intensity**

$T_A = 25\text{ °C}$

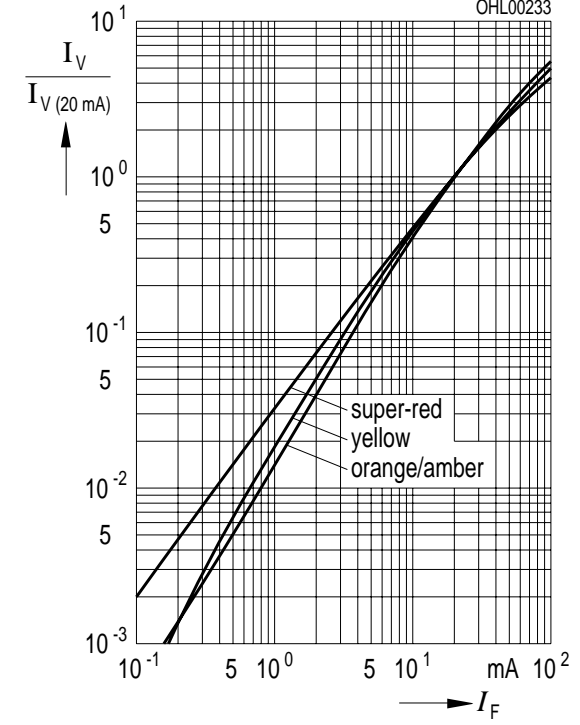

**Maximal zulässiger Durchlassstrom  $I_F = f(T)$**   
**Max. Permissible Forward Current**

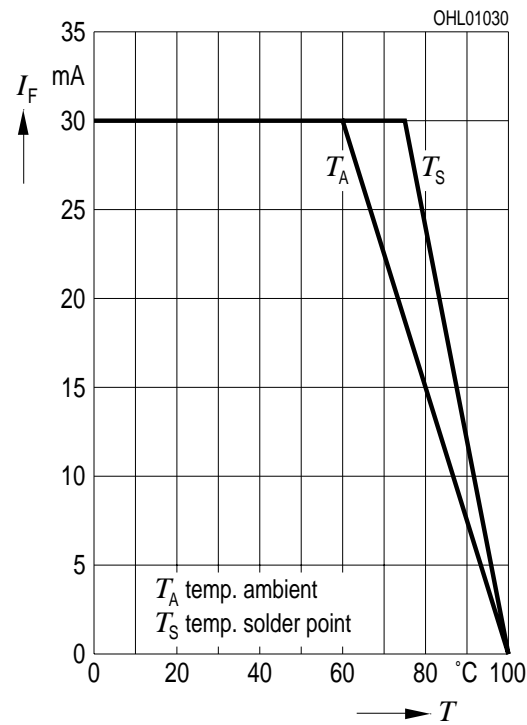

**Relative Lichtstärke  $I_V/I_{V(25\text{ °C})} = f(T_A)$**   
**Relative Luminous Intensity**

$I_F = 20\text{ mA}$

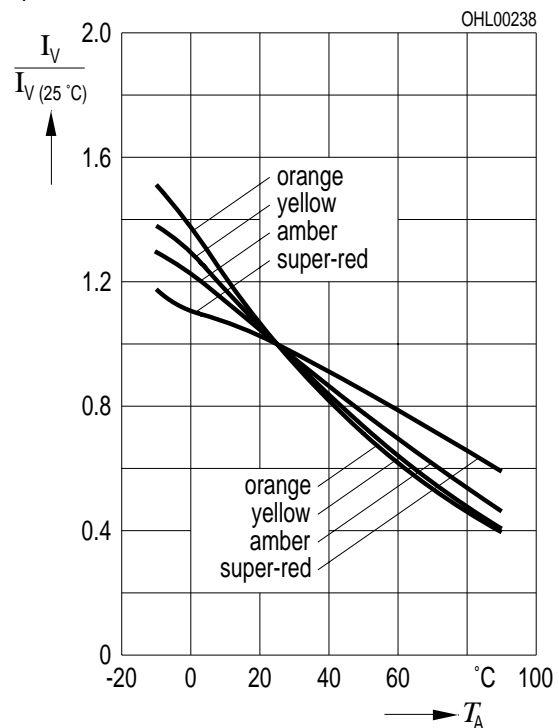

**Zulässige Impulsbelastbarkeit  $I_F = f(t_p)$**   
**Permissible Pulse Handling Capability**  
 Duty cycle  $D =$  parameter,  $T_A = 25\text{ °C}$   
**LS, LA, LO**

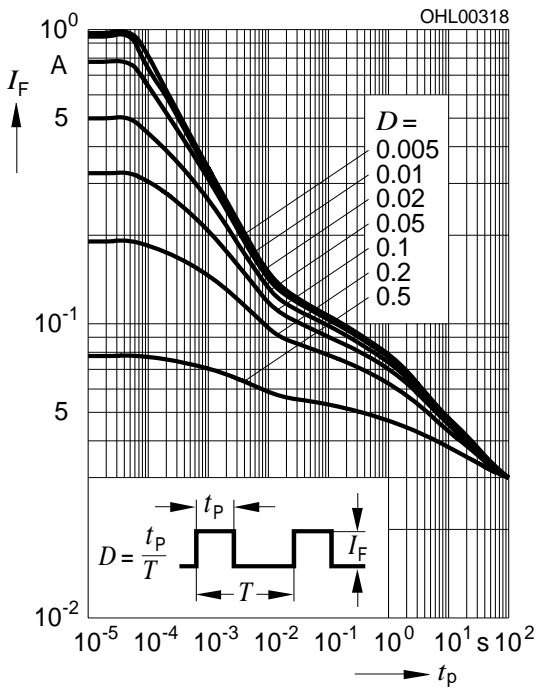

**Zulässige Impulsbelastbarkeit  $I_F = f(t_p)$**   
**Permissible Pulse Handling Capability**  
 Duty cycle  $D =$  parameter,  $T_A = 25\text{ °C}$   
**LY**

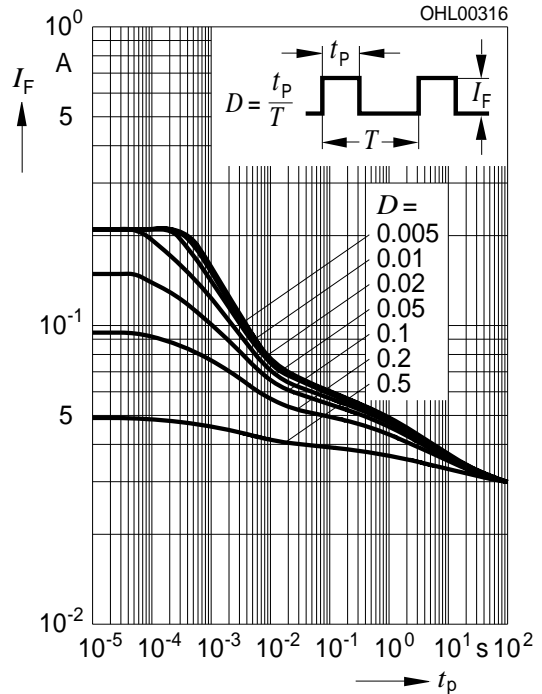

**Zulässige Impulsbelastbarkeit  $I_F = f(t_p)$**   
**Permissible Pulse Handling Capability**  
 Duty cycle  $D =$  parameter,  $T_A = 85\text{ °C}$   
**LS, LA, LO**

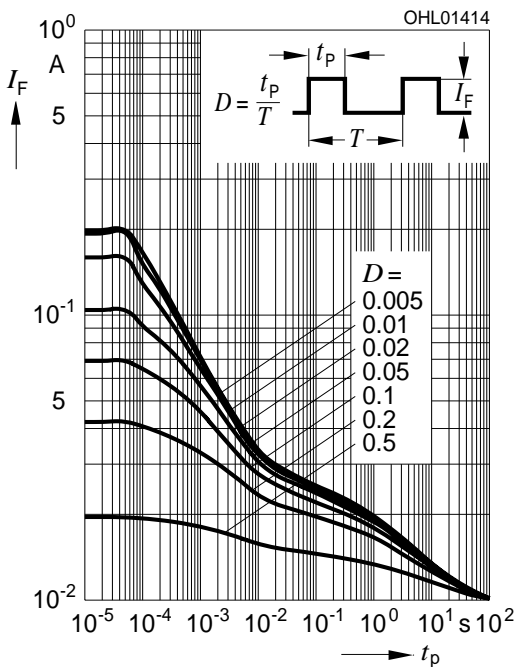

**Zulässige Impulsbelastbarkeit  $I_F = f(t_p)$**   
**Permissible Pulse Handling Capability**  
 Duty cycle  $D =$  parameter,  $T_A = 85\text{ °C}$   
**LY**

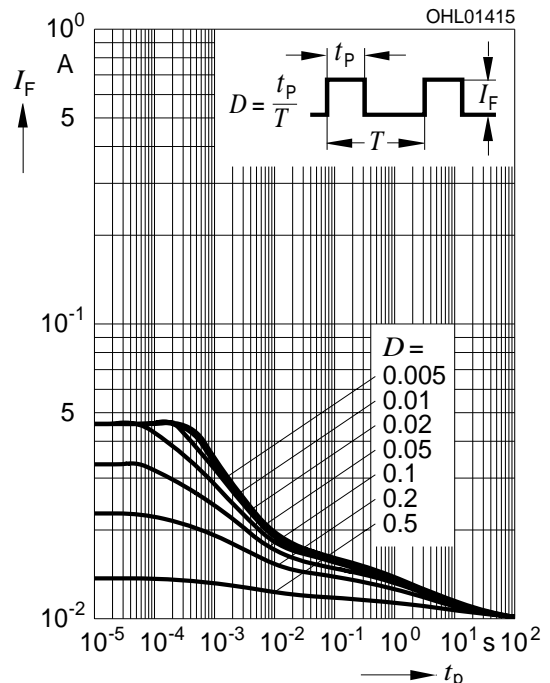



**Maßzeichnung**  
**Package Outlines**

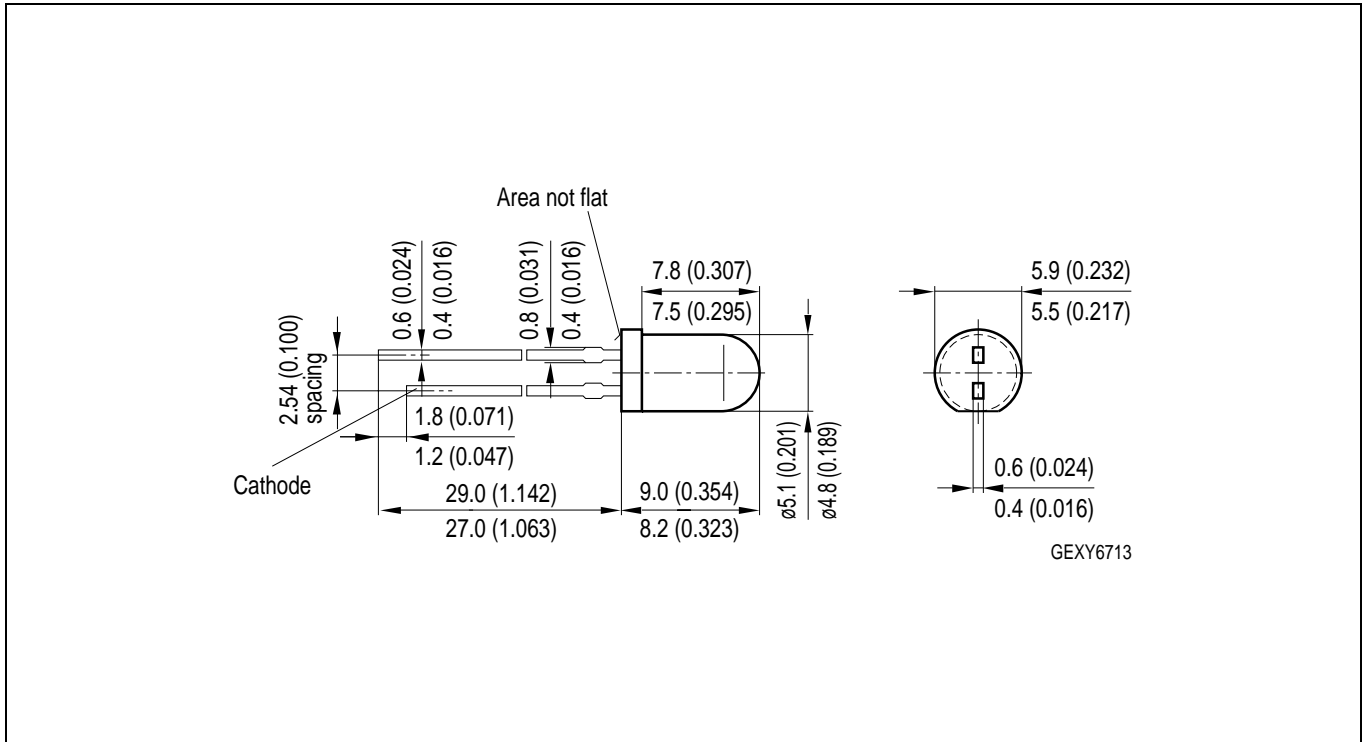

Maße werden wie folgt angegeben: mm (inch) / Dimensions are specified as follows: mm (inch).

**Kathodenkennung:** kürzerer Lötspieß  
**Cathode mark:** short solder lead  
**Gewicht / Approx. weight:** 0.35 g

**Lötbedingungen**  
**Soldering Conditions**

**Wellenlöten (TTW)(nach CECC 00802)**  
**TTW Soldering(acc. to CECC 00802)**

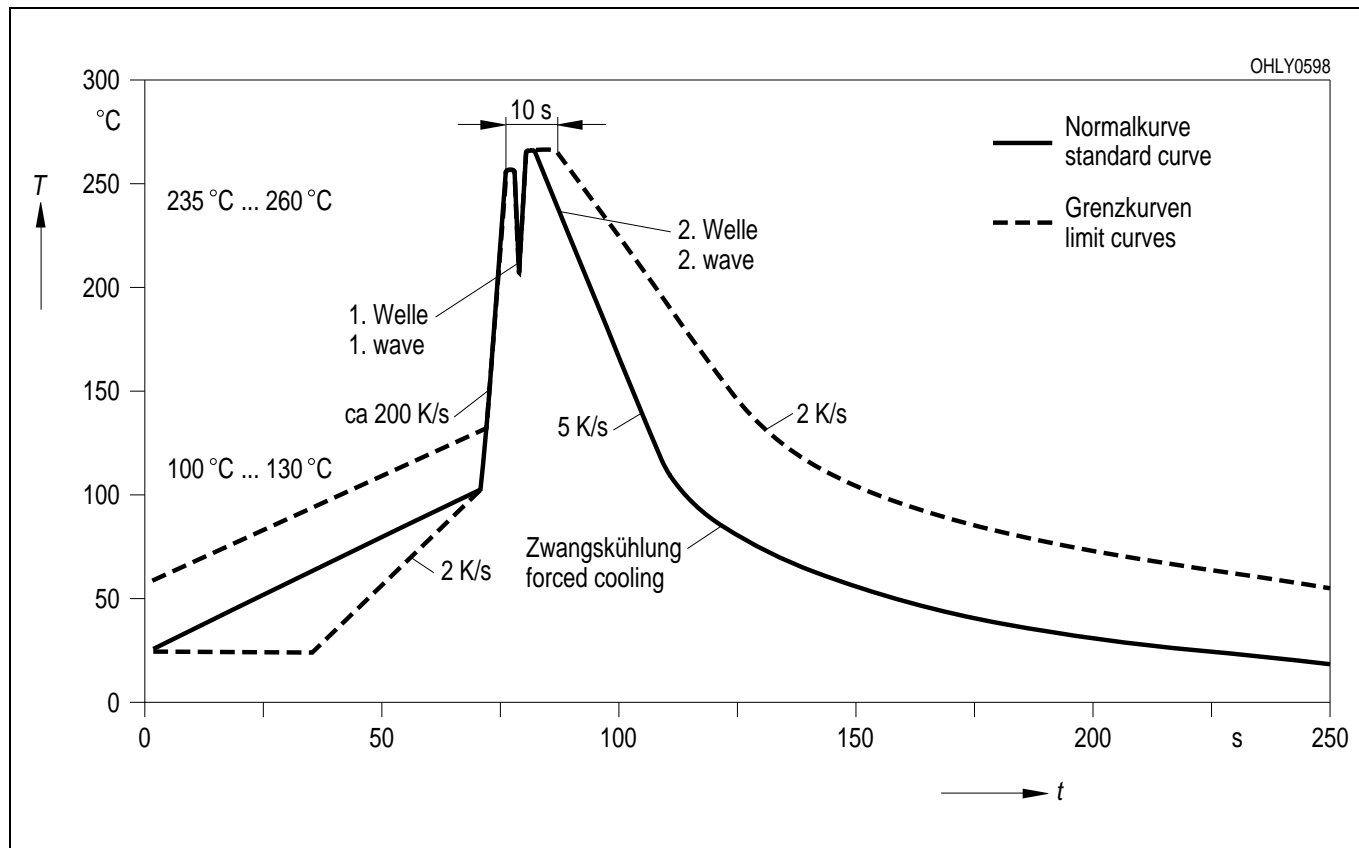

**Empfohlenes Lötpaddesign** Wellenlöten (TTW)  
**Recommended Solder Pad** TTW Soldering

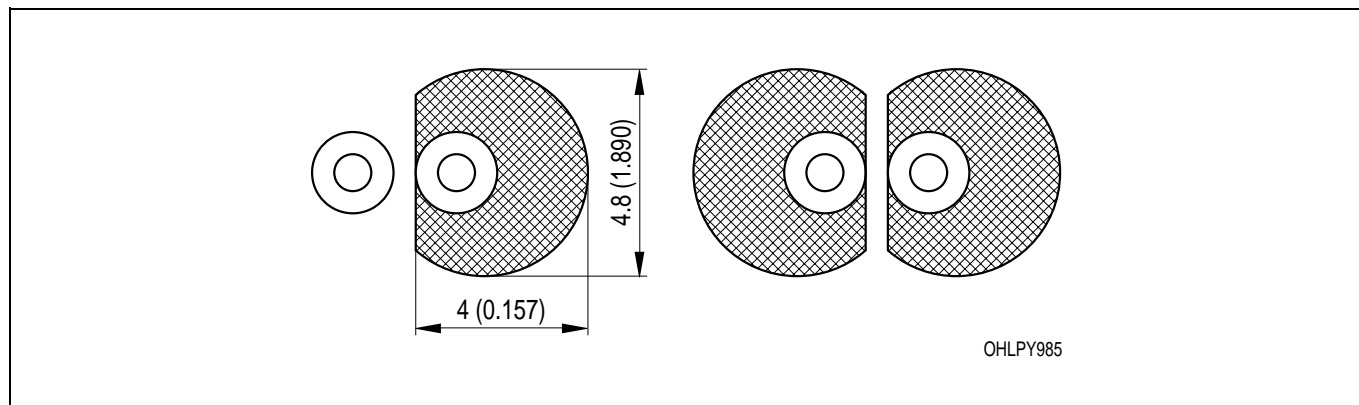

Maße werden wie folgt angegeben: mm (inch) / Dimensions are specified as follows: mm (inch)

**Revision History: 2001-02-12**

Previous Version: 2001-02-12

Page	Subjects (major changes since last revision)

**Published by OSRAM Opto Semiconductors GmbH & Co. OHG**

**Wernerwerkstrasse 2, D-93049 Regensburg**

**© All Rights Reserved.**

**Attention please!**

The information describes the type of component and shall not be considered as assured characteristics. Terms of delivery and rights to change design reserved. Due to technical requirements components may contain dangerous substances. For information on the types in question please contact our Sales Organization. If printed or downloaded, please find the latest version in the Internet.

**Packing**

Please use the recycling operators known to you. We can also help you – get in touch with your nearest sales office. By agreement we will take packing material back, if it is sorted. You must bear the costs of transport. For packing material that is returned to us unsorted or which we are not obliged to accept, we shall have to invoice you for any costs incurred.

**Components used in life-support devices or systems must be expressly authorized for such purpose!** Critical components <sup>1</sup> may only be used in life-support devices or systems <sup>2</sup> with the express written approval of OSRAM OS.

<sup>1</sup> A critical component is a component used in a life-support device or system whose failure can reasonably be expected to cause the failure of that life-support device or system, or to affect its safety or the effectiveness of that device or system.

<sup>2</sup> Life support devices or systems are intended (a) to be implanted in the human body, or (b) to support and/or maintain and sustain human life. If they fail, it is reasonable to assume that the health of the user may be endangered.