

2.0A Output Type Low Power-Loss Voltage Regulator

FEATURES

- *Low power-loss(Dropout voltage: 0.5V(max) at $I_o=2.0A$)
- *2.0A output type
- * Output voltage precision: $\pm 3.0\%$
- *Built-in ON/OFF control function
- *Built in over current, overheat protection function, ASO protection circuit.
- *Lead forming type is also available.

APPLICATIONS

*Power supplies for various electronic equipment such as AV,OA equipment.

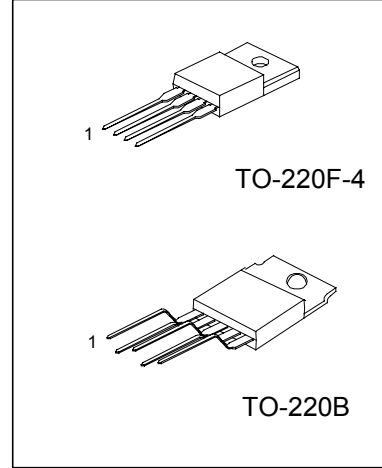

INTERNAL CONNECTION DIAGRAM

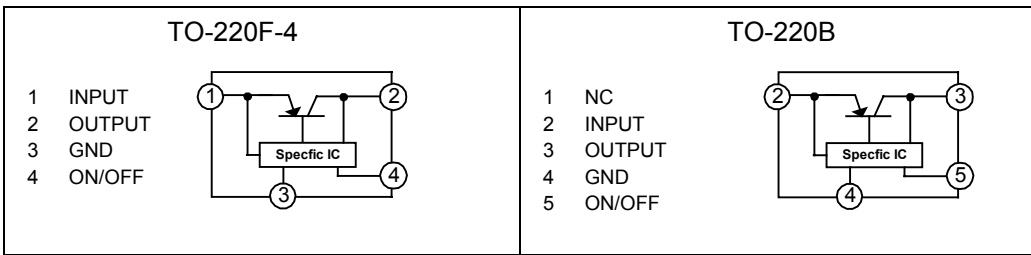

Model Line-ups

	2.0A output
3.3V output	R33LD20
5.0V output	R05LD20
9.0V output	R09LD20
12.0V output	R12LD20

ABSOLUTE MAXIMUM RATINGS (Ta=25°C)

PARAMETER	SYMBOL	RATING	UNIT
Input voltage ^(note 1)	V_{IN}	20	V
ON/OFF control terminal voltage ^(note1)	V_C	20	V
Output current	I_o	2.0	A
Power dissipation ^(note2)	P_{D1}	1.4	W
	P_{D2}	15	W
Junction temperature ^(note3)	T_j	150	°C
Operating temperature	T_{opr}	-20 ~ +80	°C
Storage temperature	T_{stg}	-40 ~ +150	°C
Soldering temperature	T_{sol}	260(For 10s)	°C

note1 : All are open except GND and applicable terminals.

UTC RXXLD20 LINEAR INTEGRATED CIRCUIT

note2 : P_{D1}:No heat sink; P_{D2}:With infinite heat sink

note3 : Overheat protection may operate at 125 ≤ T_j ≤ 150°C

UTC R33LD20 ELECTRICAL CHARACTERISTICS

(refer to the test circuits, unless otherwise specified, T_a=25°C)

PARAMETER	SYMBOL	TEST CONDITIONS	MIN	TYP	MAX	UNIT
Output voltage	V _o	V _{in} =5V, I _o =1A	3.201	3.3	3.399	V
Line regulation	ΔV _o	V _{in} =4~10V, I _o =5mA		0.1	2.5	%
Load regulation	ΔV _o	V _{in} =5V, I _o =5mA ~2.0A		0.1	2.0	%
Temperature coefficient of output voltage	T _c V _o	T _j =0~125°C, I _o =5mA		±0.02		%/°C
Ripple rejection	RR	Refer to Fig.2	45	55		dB
Dropout voltage	V _d	(note4), I _o =2A			0.5	V
ON-state voltage for control (note5)	V _{c(ON)}	V _{in} =5V	2.0			V
ON-state current for control	I _{c(ON)}	V _c =2.7V, V _{in} =5V			20	μA
OFF-state voltage for control	V _{c(OFF)}	V _{in} =5V			0.8	V
OFF-state current for control	I _{c(OFF)}	V _c =0.4V, V _{in} =5V			-0.4	mA
Quiescent current	I _q	I _o =0A, V _{in} =5V			10	mA

UTC R05LD20 ELECTRICAL CHARACTERISTICS

(refer to the test circuits, unless otherwise specified, T_a=25°C)

PARAMETER	SYMBOL	TEST CONDITIONS	MIN	TYP	MAX	UNIT
Output voltage	V _o	V _{in} =7V, I _o =1A	4.85	5.0	5.15	V
Line regulation	ΔV _o	V _{in} =6~12V, I _o =5mA		0.5	2.5	%
Load regulation	ΔV _o	V _{in} =7V, I _o =5mA ~2.0A		0.1	2.0	%
Temperature coefficient of output voltage	T _c V _o	T _j =0~125°C, I _o =5mA		±0.02		%/°C
Ripple rejection	RR	Refer to Fig.2	45	55		dB
Dropout voltage	V _d	(note4), I _o =2A			0.5	V
ON-state voltage for control (note5)	V _{c(ON)}	V _{in} =7V	2.0			V
ON-state current for control	I _{c(ON)}	V _c =2.7V, V _{in} =7V			20	μA
OFF-state voltage for control	V _{c(OFF)}	V _{in} =7V			0.8	V
OFF-state current for control	I _{c(OFF)}	V _c =0.4V, V _{in} =7V			-0.4	mA
Quiescent current	I _q	I _o =0A, V _{in} =7V			10	mA

UTC RXXLD20 LINEAR INTEGRATED CIRCUIT

UTC R09LD20 ELECTRICAL CHARACTERISTICS

(refer to the test circuits, unless otherwise specified, Ta=25°C)

PARAMETER	SYMBOL	TEST CONDITIONS	MIN	TYP	MAX	UNIT
Output voltage	Vo	Vin=11V, Io=1A	8.73	9.0	9.27	V
Line regulation	ΔV_o	Vin=10~16V, Io=5mA		0.5	2.5	%
Load regulation	ΔV_o	Vin=11V, Io=5mA ~2.0A		0.1	2.0	%
Temperature coefficient of output voltage	TcVo	Tj=0~125°C, Io=5mA		±0.02		%/°C
Ripple rejection	RR	Refer to Fig.2	45	55		dB
Dropout voltage	Vd	(note4), Io=2A			0.5	V
ON-state voltage for control (note5)	Vc(ON)	Vin=11V	2.0			V
ON-state current for control	Ic(ON)	Vc=2.7V, Vin=11V			20	μA
OFF-state voltage for control	Vc(OFF)	Vin=11V			0.8	V
OFF-state current for control	Ic(OFF)	Vc=0.4V, Vin=11V			-0.4	mA
Quiescent current	Iq	Io=0A, Vin=11V			10	mA

UTC R12LD20 ELECTRICAL CHARACTERISTICS

(refer to the test circuits, unless otherwise specified, Ta=25°C)

PARAMETER	SYMBOL	TEST CONDITIONS	MIN	TYP	MAX	UNIT
Output voltage	Vo	Vin=14V, Io=1A	11.64	12.0	12.36	V
Line regulation	ΔV_o	Vin=13~19V, Io=5mA		0.5	2.5	%
Load regulation	ΔV_o	Vin=14V, Io=5mA ~2.0A		0.1	2.0	%
Temperature coefficient of output voltage	TcVo	Tj=0~125°C, Io=5mA		±0.02		%/°C
Ripple rejection	RR	Refer to Fig.2	45	55		dB
Dropout voltage	Vd	(note4), Io=2A			0.5	V
ON-state voltage for control (note5)	Vc(ON)	Vin=14V	2.0			V
ON-state current for control	Ic(ON)	Vc=2.7V, Vin=14V			20	μA
OFF-state voltage for control	Vc(OFF)	Vin=14V			0.8	V
OFF-state current for control	Ic(OFF)	Vc=0.4V, Vin=14V			-0.4	mA
Quiescent current	Iq	Io=0A, Vin=14V			10	mA

note4 : Input voltage shall be the value when output voltage is 95% in comparison with the initial value.

note5 : TO-220B: In case of opening control terminal ⑤, output voltage turns on.

TO-220F-4: In case of opening control terminal ④, output voltage turns on.

UTC RXXLD20 LINEAR INTEGRATED CIRCUIT

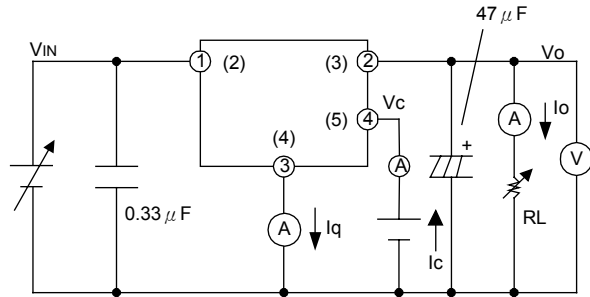

() : TO-220B

Fig.1 Test Circuit

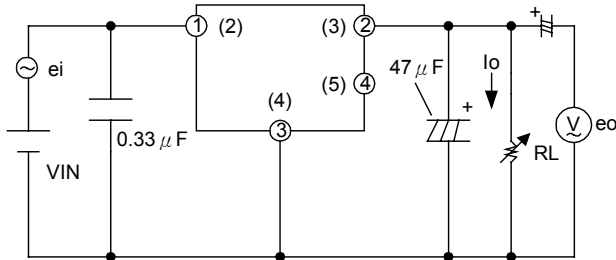

() : TO-220B

VIN=5V(R33LD20)
7V(R05LD20)
11V(R09LD20)
14V(R12LD20)

f=120Hz
ei=0.5Vrms
Io=0.5A
RR=20log(ei/eo)

Fig.2 Test Circuit of Ripple Rejection

Fig.3 Power Dissipation vs. Ambient Temperature

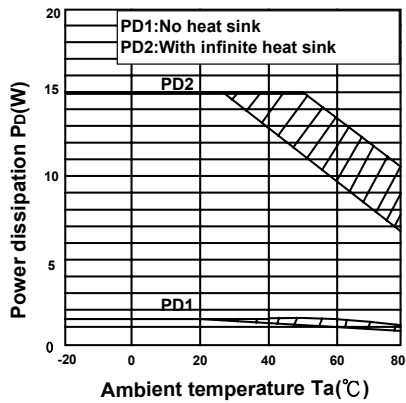

Note) Oblique line portion:Overheat protection may operate in this area.

Fig.4 Overcurrent Protection Characteristics(Typical Value) (R33LD20)

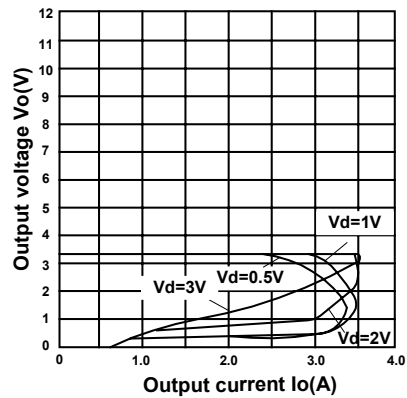

Fig.5 Overcurrent Protection Characteristics (Typical Value)(R05LD20)

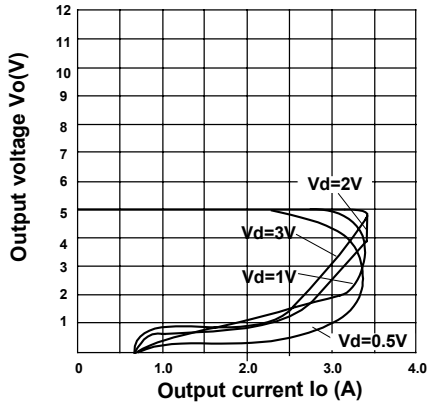

Fig.6 Overcurrent Protection Characteristics (Typical Value)(R09LD20)

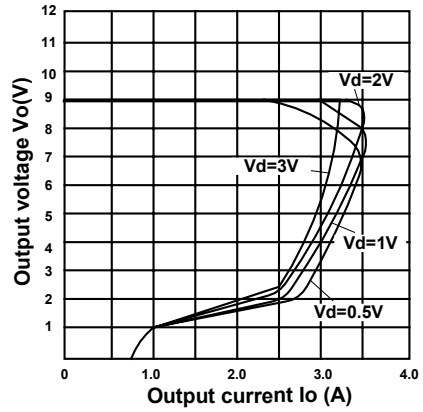

Fig.7 Overcurrent Protection Characteristics (Typical Value)(R12LD20)

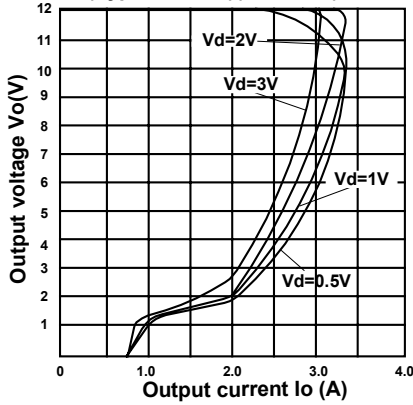

Fig.8 Output Voltage Deviation vs .Junction Temperature (R03LD20)

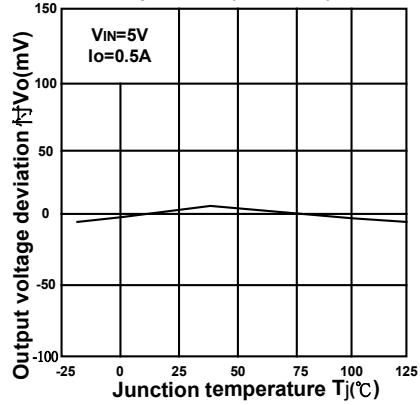

Fig.9 Output Voltage Deviation vs .Junction Temperature (R05LD20)

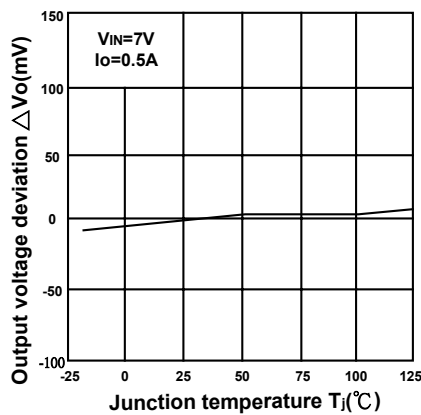

Fig.10 Output Voltage Deviation vs .Junction Temperature (R09LD20)

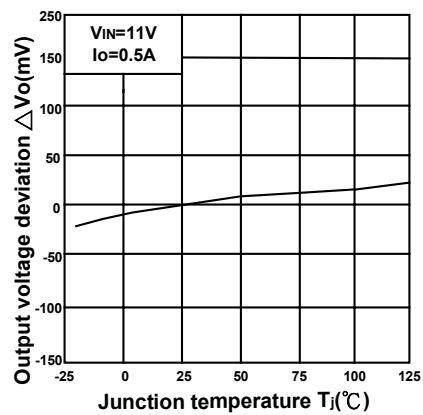

Fig.11 Output Voltage Deviation vs .Junction Temperature (R12LD20)

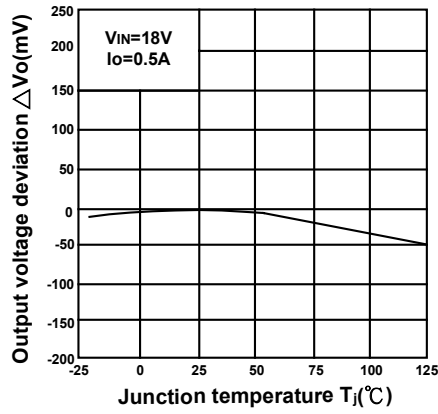

Fig.12 Output Voltage vs .Input Voltage (R33LD20)

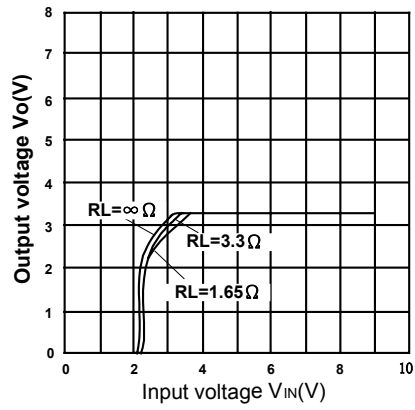

Fig.13 Output Voltage vs .Input Voltage (R05LD20)

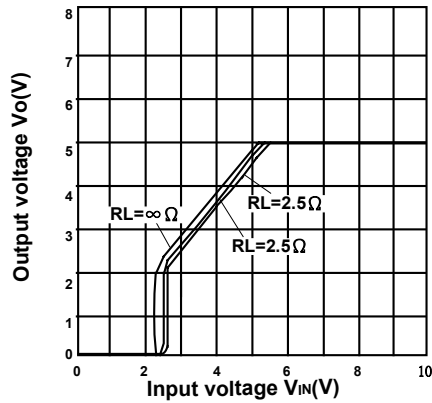

Fig.14 Output Voltage vs .Input Voltage (R09LD20)

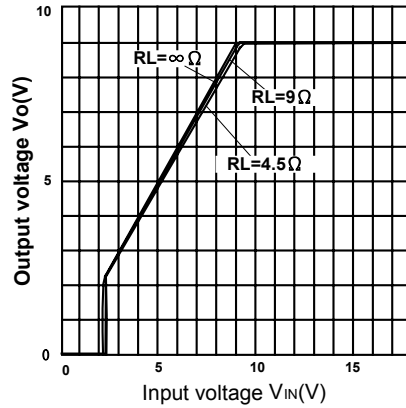

Fig.15 Output Voltage vs .Input Voltage (R12LD20)

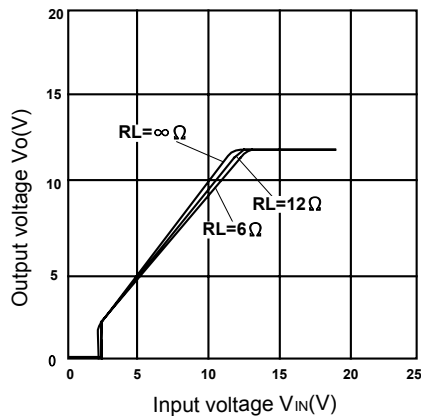

Fig.16 Circuit Operating Current vs .Input Voltage (R33LD20)

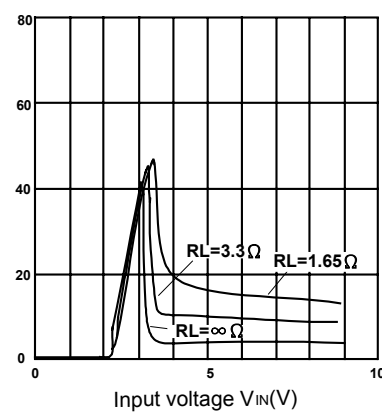

Fig.17 Circuit Operating Current vs .Input Voltage (R05LD20)

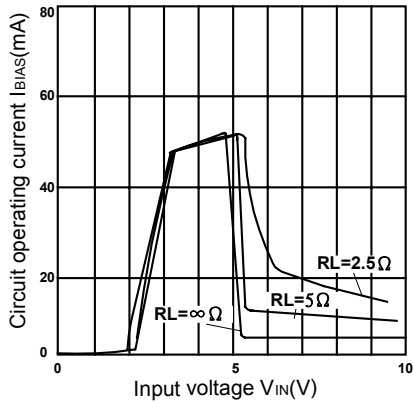

Fig.18 Circuit Operating Current vs .Input Voltage (R09LD20)

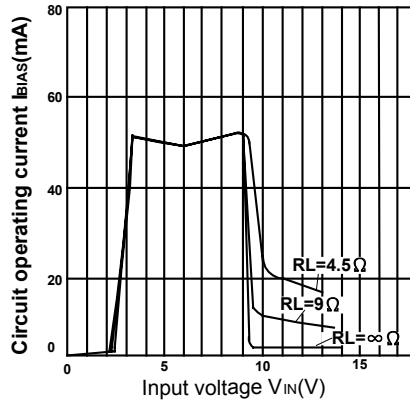

Fig.19 Circuit Operating Current vs .Input Voltage (R12LD20)

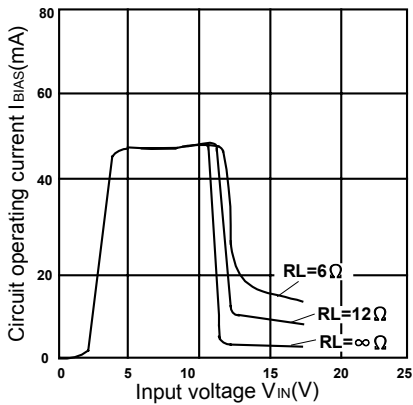

Fig.20 Dropout Voltage vs .Junction Temperature

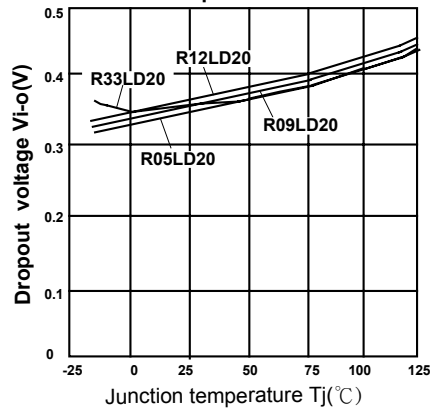

Fig.21 Quiescent Current vs .Junction Temperature

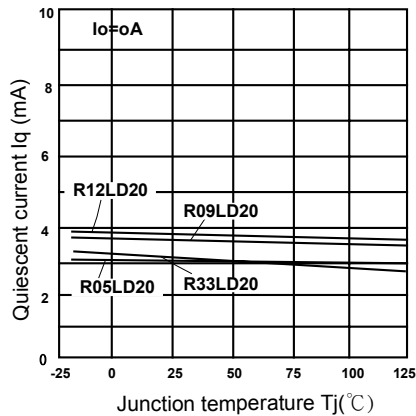
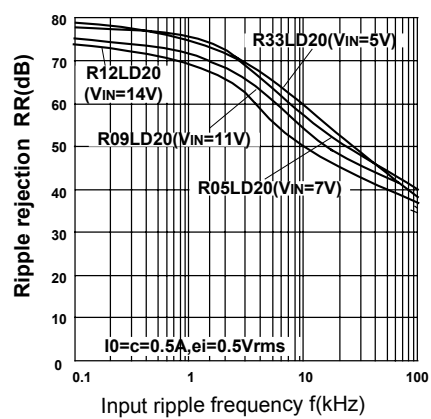

Fig.22 Ripple Rejection vs .Input Ripple Frequency



UTC RXXLD20 LINEAR INTEGRATED CIRCUIT

TYPICAL APPLICATION

