HD66730/HD66731

(Dot-Matrix Liquid Crystal Display Controller/Driver Supporting Japanese Kanji, Korean Font Display)

HITACHI

ADE-207-313(Z)

'99.9

Rev. 0.0

Description

The HD66730/1 is a dot-matrix liquid crystal display controller (LCD) and driver LSI that displays Japanese characters consisting of kanji, hiragana and katakana according to the Japanese Industrial Standard (JIS) Level-1 Kanji Set. The HD66730/1 incorporates the following five functions on a single chip: (i) display control function for the dot matrix LCD, (ii) a display RAM to store character codes, (iii) ROM fonts to support kanji, (iv) liquid crystal driver, and (v) a booster to drive the LCD. A two 6-character (HD66730) or four 10-character (HD66731) kanji display can easily be achieved by receiving character codes (2 bytes/character) from the MPU.

The font ROM includes 2,965 kanji from the JIS Level-1 Kanji Set, 524 JIS non-kanji characters, and 128 half-size alphanumeric characters and symbols. Full-size fonts such as Japanese kanji and half-size of fonts such as alphanumeric characters can be displayed together.

In addition, display control equivalent to full bit mapping can be performed through horizontal and vertical dot-by-dot smooth scroll functions for each display line. To help make systems more compact, a three-line clock synchronous serial transfer method is adopted in addition to an 8-bit bus for interfacing with a microcomputer.

Features

- Dot-matrix liquid crystal display controller/driver supporting the display of kanji according to JIS Level-1 Kanji Set
- Large character generator ROM: 510 kbits
 - Kanji according to JIS Level-1 Kanji Set (11 × 12 dots): 2,965-character font
 - JIS non-kanji (11 × 12 dots): 524-character font
 - Half-size alphanumeric characters and symbols (5 × 12 dots): 128-character font
- Display of 11 × 12 dots for full-size fonts consisting of kanji and kana, 5 × 12 dots for half-size fonts of alphanumeric characters and symbols in the same display
- 2-line 6-character full-size font display with a single chip (HD66730)
- 4-line 10-character full-size font display with a single chip (HD66731)
- Expansion driver interface: maximum 2-line 20-character (or 4-line 10-character) display (HD66730)
- Dot matrix font and 71 marks and icons (96 at HD66731)

HD66730/HD66731

- Various display control functions: horizontal smooth scroll (in dot units), vertical smooth scroll, white black inversion/blinking/white black inversion blinking character display, cursor display, display on/off
- Display data RAM: 40×2 bytes (stores codes to support 40 characters in a full-size font)
- Character generator RAM: 8×26 bytes (displays 8 characters of a 12×13 dot user font)
- 16-byte 96-segment RAM
- Three-line clock synchronous serial bus, 8-bit bus interface
- Built-in double/triple liquid-crystal voltage booster circuit and built-in oscillator (operating frequency can be adjusted through external resistors)
- Operating power supply voltage: 2.4V to 5.5V; liquid crystal display voltage: 3.0V to 13.0V
- HD66730: QFP 1420-128 (0.5 mm pitch), bare-chip
- HD66731: TCP-171 (straight), TCP-206 (bent), chip with bump

List 1 Programmable Duty Cycles

Duty Drive Setting	Number of Display Characters in Full-Size Font		Number of Segments/Marks	
	HD66730	HD66731	HD66730	HD66731
1/14	One 6-character	One 10-character	71pcs	96pcs
1/27	Two 6-character	Two 10-character	71pcs	96pcs
1/40	—	Three 10-characters	—	96pcs
1/53	—	Four 10-characters	—	96pcs

Ordering Information

Type No.	Package	Number of Display character	CGROM
HD66730A00FS	FP-128	Two 6-characters	JIS Level-1 Kanji (A00)
HCD66730A00	Bare chip	Two 6-characters	
HD66731A00TA0L	Straight TCP	Three 8-characters	
HD66731A00TB0L	Bending TCP	Four 10-characters	
HCD66731A00BP	Au-bumped chip	Four 10-characters	
HD66730A01FS	FP-128	Two 6-characters	Korean font (A01)
HCD66730A01	Bare chip	Two 6-characters	
HD66731A01TA0L	Straight TCP	Three 8-characters	
HD66731A01TB0L	Bending TCP	Four 10-characters	
HCD66731A01BP	Au-bumped chip	Four 10-characters	

Block Diagram (HD66730)

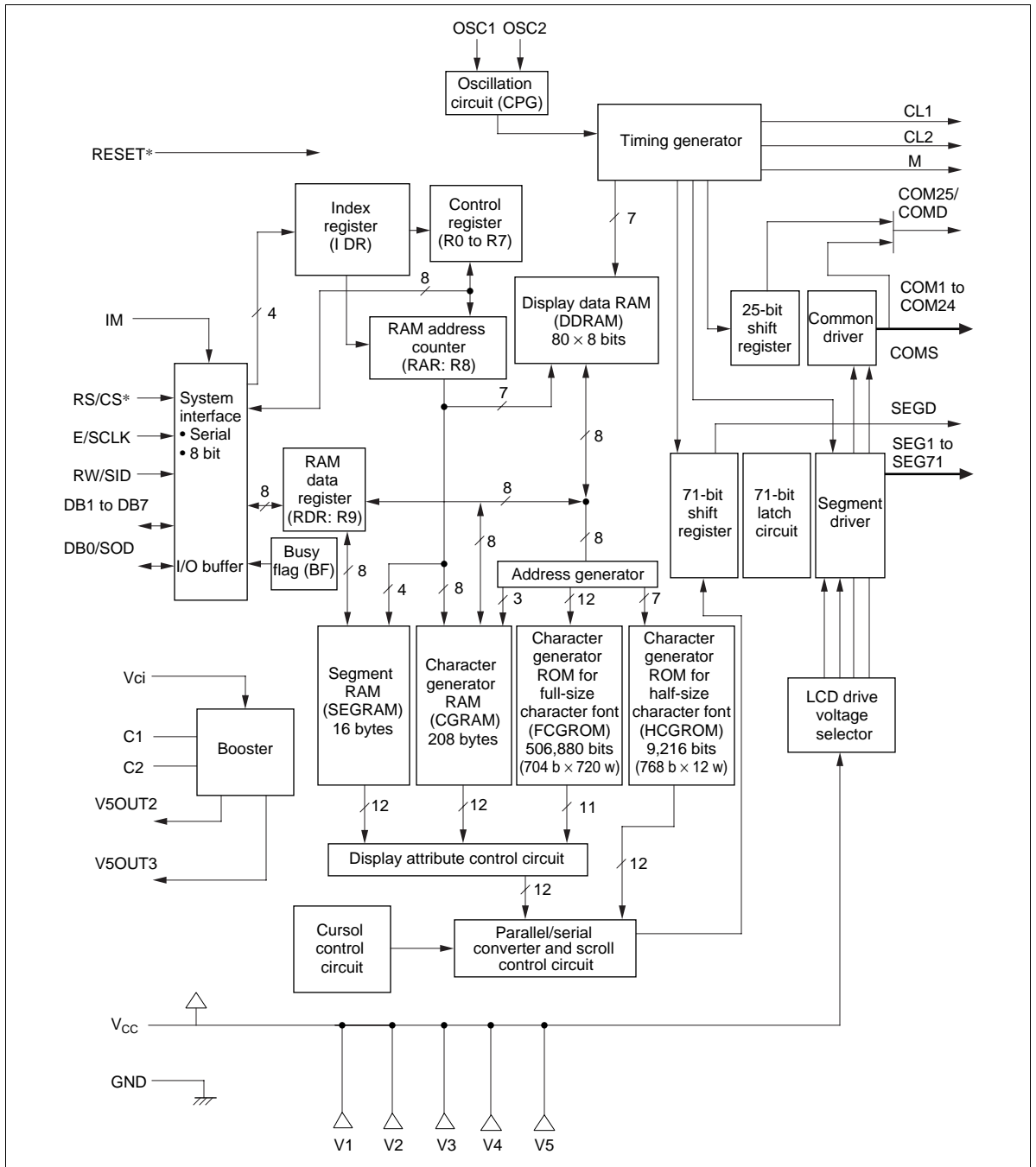

Pin Arrangement (HD66730)

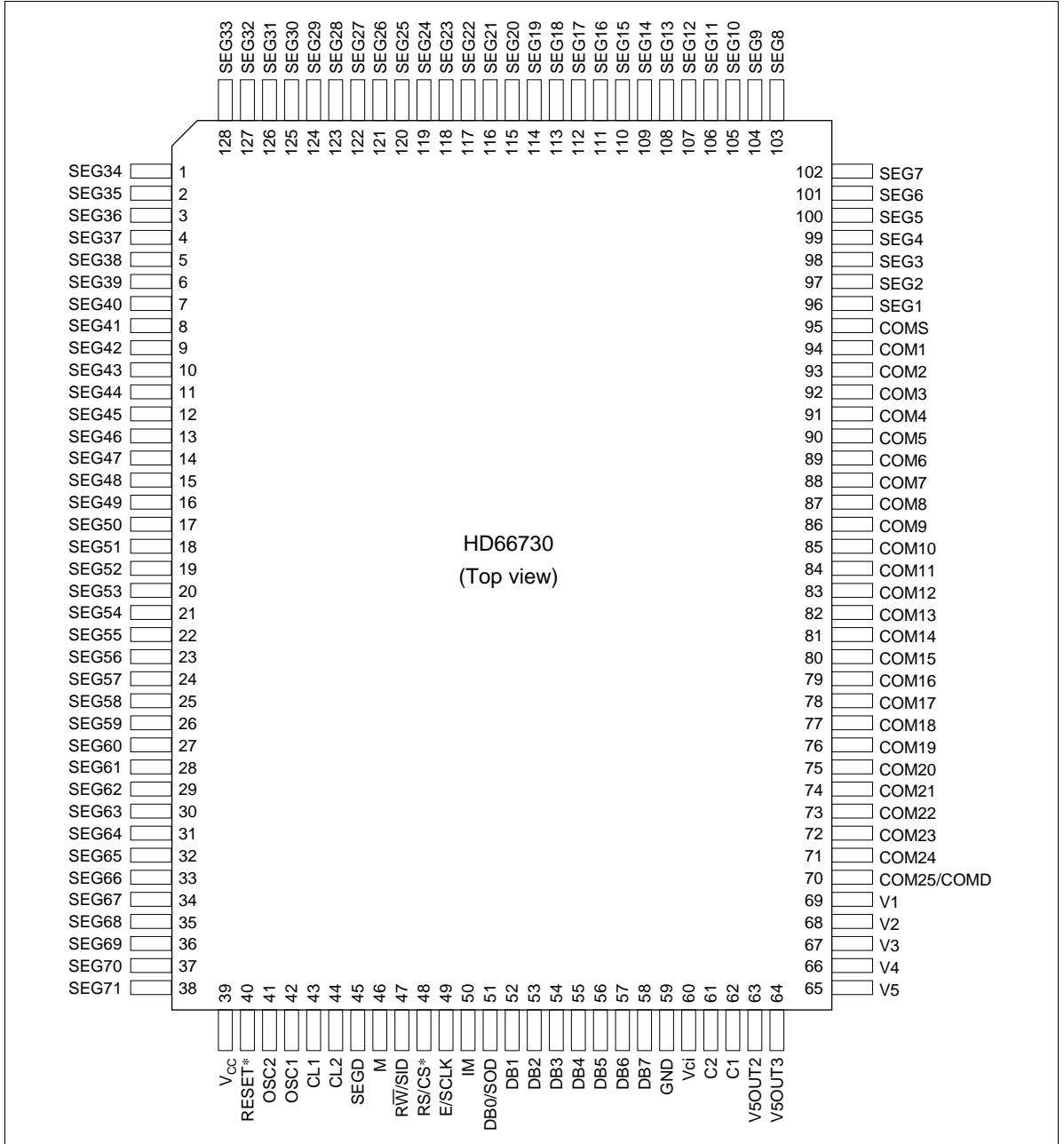

TCP Dimensions (HD66731TA0: Three 8-characters)

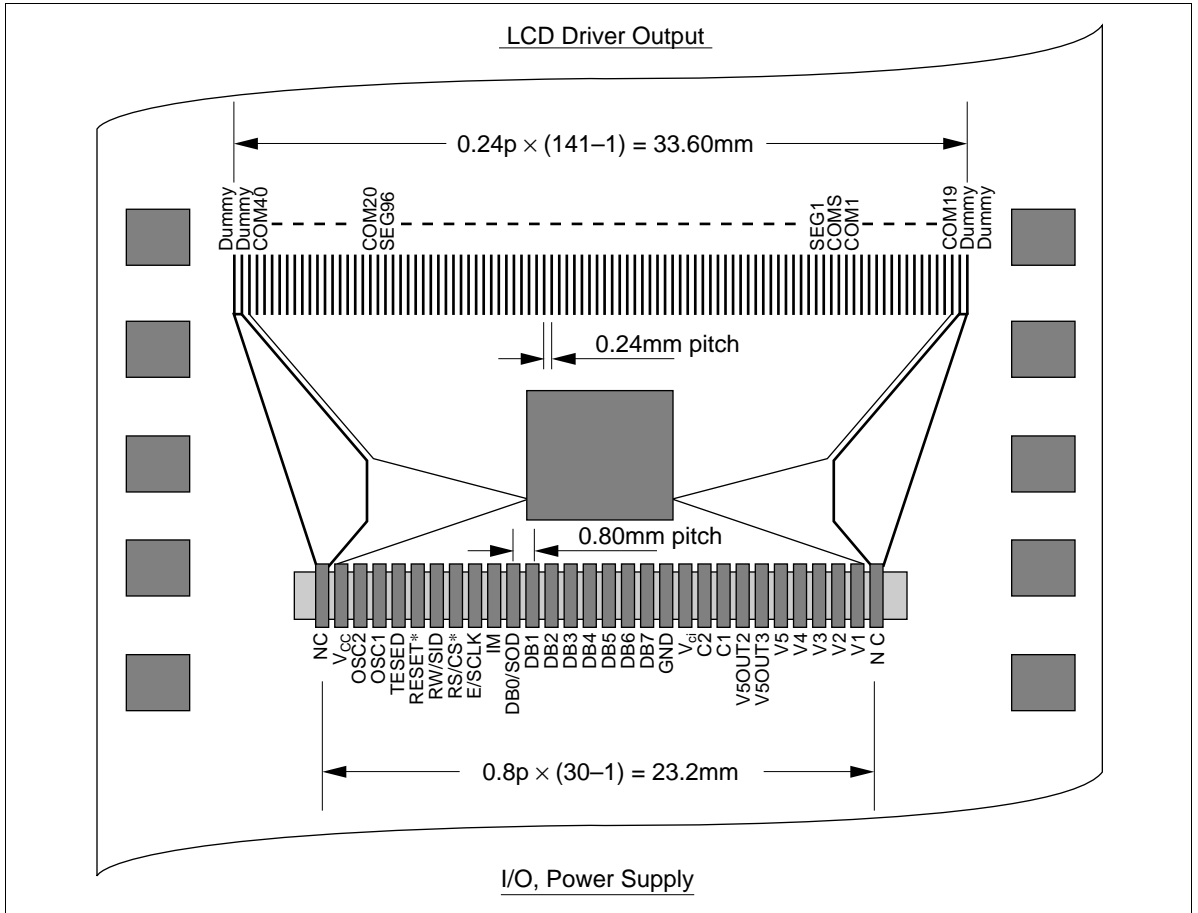

TCP Dimensions (HD66731TB0: Four 10-characters)

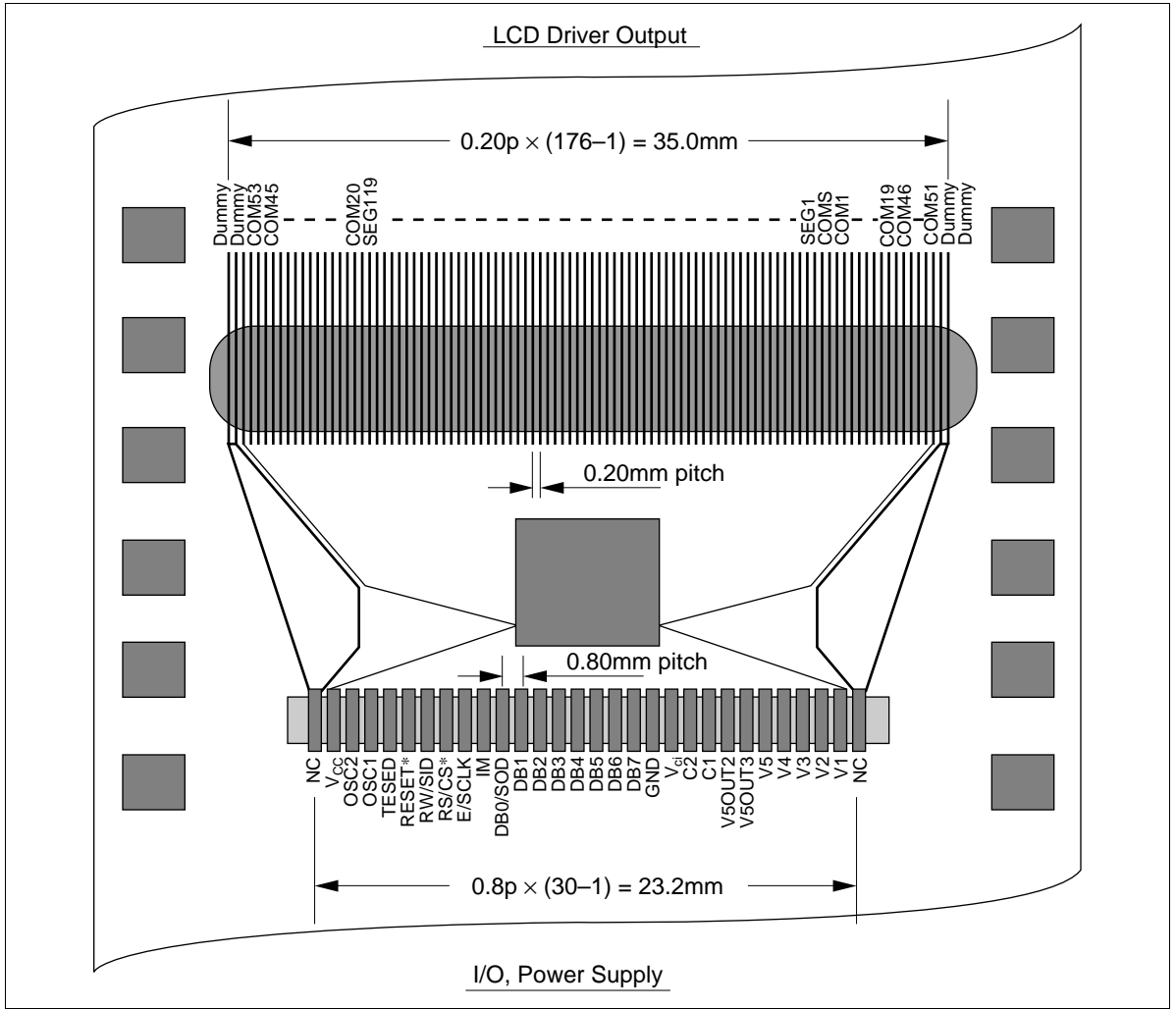

The Location of Bonding Pads (HD66730)

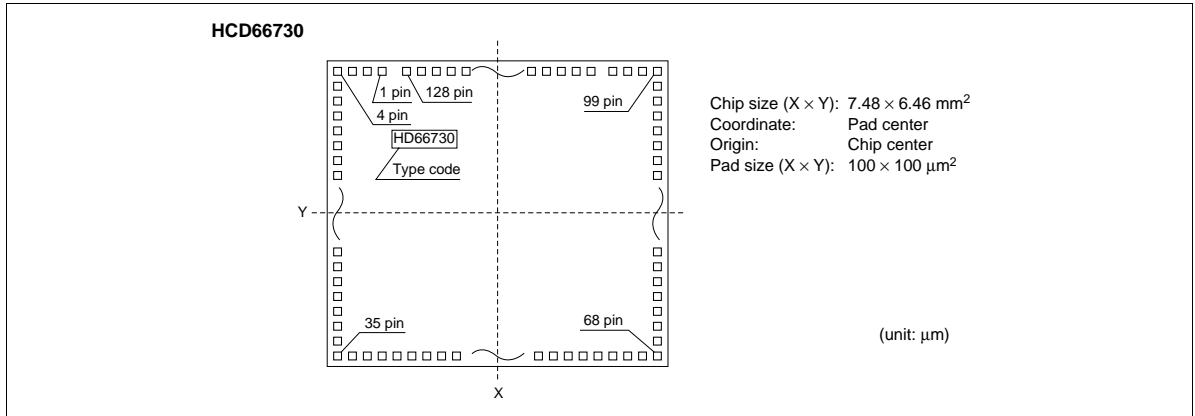

Pin No.	Function	Coordinate		Pin No.	Function	Coordinate		Pin No.	Function	Coordinate	
		X	Y			X	Y			X	Y
1	SEG34	-2602	3012	31	SEG64	-3522	-2183	61	C2	1896	-2959
2	SEG35	-2984	3012	32	SEG65	-3522	-2364	62	C1	2057	-2959
3	SEG36	-3263	3012	33	SEG66	-3522	-2544	63	V5OUT2	2219	-2959
4	SEG37	-3522	3012	34	SEG67	-3522	-2774	64	V5OUT3	2478	-2959
5	SEG38	-3522	2782	35	SEG68	-3522	-2984	65	V5	2782	-2984
6	SEG39	-3522	2582	36	SEG69	-3160	-2984	66	V4	3016	-2984
7	SEG40	-3522	2341	37	SEG70	-2860	-2984	67	V3	3253	-2984
8	SEG41	-3522	2161	38	SEG71	-2660	-2984	68	V2	3522	-2984
9	SEG42	-3522	1981	39	V _{CC}	-2435	-2984	69	V1	3522	-2806
10	SEG43	-3522	1801	40	RESET*	-2233	-2984	70	COM25/D	3522	-2626
11	SEG44	-3522	1621	41	OSC2	-2063	-2984	71	COM24	3522	-2445
12	SEG45	-3522	1440	42	OSC1	-1859	-2984	72	COM23	3522	-2265
13	SEG46	-3522	1260	43	CL1	-1689	-2984	73	COM22	3522	-2085
14	SEG47	-3522	1030	44	CL2	-1519	-2984	74	COM21	3522	-1855
15	SEG48	-3522	800	45	SEGD	-1349	-2984	75	COM20	3522	-1625
16	SEG49	-3522	620	46	M	-1179	-2984	76	COM19	3522	-1444
17	SEG50	-3522	439	47	RW/SID	-975	-2984	77	COM18	3522	-1264
18	SEG51	-3522	259	48	RS/CS*	-771	-2984	78	COM17	3522	-1084
19	SEG52	-3522	79	49	E/SCLK	-567	-2984	79	COM16	3522	-854
20	SEG53	-3522	-101	50	IM	-363	-2984	80	COM15	3522	-624
21	SEG54	-3522	-281	51	DB0/SOD	-146	-2984	81	COM14	3522	-443
22	SEG55	-3522	-462	52	DB1	71	-2984	82	COM13	3522	-263
23	SEG56	-3522	-642	53	DB2	287	-2984	83	COM12	3522	-83
24	SEG57	-3522	-822	54	DB3	504	-2984	84	COM11	3522	97
25	SEG58	-3522	-1002	55	DB4	721	-2984	85	COM10	3522	277
26	SEG59	-3522	-1182	56	DB5	938	-2984	86	COM9	3522	458
27	SEG60	-3522	-1363	57	DB6	1154	-2984	87	COM8	3522	638
28	SEG61	-3522	-1543	58	DB7	1371	-2984	88	COM7	3522	818
29	SEG62	-3522	-1723	59	GND	1533	-2984	89	COM6	3522	998
30	SEG63	-3522	-1939	60	V _{ci}	1730	-2959	90	COM5	3522	1178

HD66730/HD66731

Pin No.	Function	Coordinate	
		X	Y
91	COM4	3522	1409
92	COM3	3522	1639
93	COM2	3522	1819
94	COM1	3522	1999
95	COMS	3522	2179
96	SEG1	3522	2410
97	SEG2	3522	2590
98	SEG3	3522	2819
99	SEG4	3522	3012
100	SEG5	3222	3012
101	SEG6	2942	3012
102	SEG7	2662	3012
103	SEG8	2332	3012

Pin No.	Function	Coordinate	
		X	Y
104	SEG9	2152	3012
105	SEG10	1972	3012
106	SEG11	1791	3012
107	SEG12	1611	3012
108	SEG13	1431	3012
109	SEG14	1251	3012
110	SEG15	1071	3012
111	SEG16	890	3012
112	SEG17	710	3012
113	SEG18	530	3012
114	SEG19	350	3012
115	SEG20	170	3012
116	SEG21	-11	3012

Pin No.	Function	Coordinate	
		X	Y
117	SEG22	-191	3012
118	SEG23	-371	3012
119	SEG24	-551	3012
120	SEG25	-731	3012
121	SEG26	-912	3012
122	SEG27	-1092	3012
123	SEG28	-1272	3012
124	SEG29	-1452	3012
125	SEG30	-1632	3012
126	SEG31	-1813	3012
127	SEG32	-1993	3012
128	SEG33	-2173	3012

The Location of Bonding Pads (HD66731)

- Chip size : 7.48 × 6.46mm²
- Coordinate : Pad center
- Origin : Chip center
- Au bumped distance : 80μm (Min.)
- Bump size : 100μm × 50μm

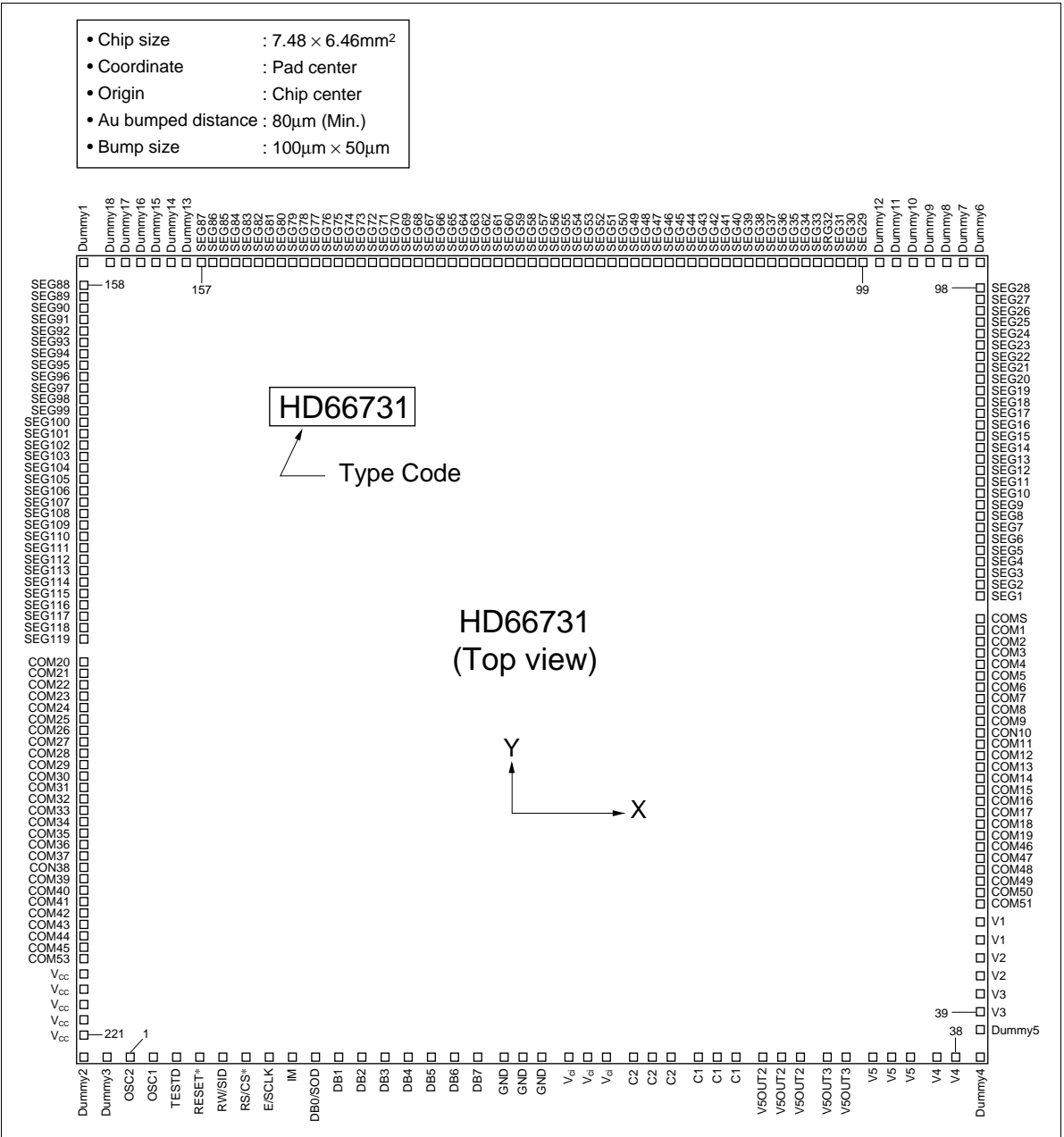

HD66730/HD66731

Pin No.	Function	Coordinate		Pin No.	Function	Coordinate		Pin No.	Function	Coordinate	
		X	Y			X	Y			X	Y
—	Dummy3	-3202	-2984	45	COM51	3474	-1621	92	SEG22	3474	2255
1	OSC2	-2926	-2984	46	COM50	3474	-1541	93	SEG23	3474	2335
2	OSC1	-2722	-2984	47	COM49	3474	-1460	94	SEG24	3474	2416
3	TESTD	-2543	-2984	48	COM48	3474	-1379	95	SEG25	3474	2497
4	RESET*	-2339	-2984	49	COM47	3474	-1298	96	SEG26	3474	2578
5	RW/SID	-2135	-2984	50	COM46	3474	-1218	97	SEG27	3474	2658
6	RS/CS	-1931	-2984	51	COM19	3474	-1137	98	SEG28	3474	2739
7	E/SCLK	-1727	-2984	52	COM18	3474	-1056	—	dummy6	3474	3027
8	IM	-1523	-2984	53	COM17	3474	-975	—	dummy7	3202	3027
9	DB0/SOD	-1306	-2984	54	COM16	3474	-895	—	dummy8	3066	3027
10	DB1	-1090	-2984	55	COM15	3474	-814	—	dummy9	2930	3027
11	DB2	-873	-2984	56	COM14	3474	-733	—	dummy10	2794	3027
12	DB3	-656	-2984	57	COM13	3474	-652	—	dummy11	2658	3027
13	DB4	-439	-2984	58	COM12	3474	-572	—	dummy12	2522	3027
14	DB5	-223	-2984	59	COM11	3474	-491	99	SEG29	2343	2963
15	DB6	-6	-2984	60	COM10	3474	-410	100	SEG30	2262	2963
16	DB7	211	-2984	61	COM9	3474	-329	101	SEG31	2182	2963
17	GND	373	-2971	62	COM8	3474	-249	102	SEG32	2101	2963
18	GND	509	-2971	63	COM7	3474	-168	103	SEG33	2020	2963
19	GND	645	-2971	64	COM6	3474	-87	104	SEG34	1939	2963
20	Vci	781	-2971	65	COM5	3474	-6	105	SEG35	1859	2963
21	Vci	917	-2971	66	COM4	3474	74	106	SEG36	1778	2963
22	Vci	1053	-2971	67	COM3	3474	155	107	SEG37	1697	2963
23	C2	1189	-2971	68	COM2	3474	236	108	SEG38	1616	2963
24	C2	1325	-2971	69	COM1	3474	317	109	SEG39	1536	2963
25	C2	1461	-2971	70	COMS	3474	397	110	SEG40	1455	2963
26	C1	1597	-2971	71	SEG1	3474	559	111	SEG41	1374	2963
27	C1	1733	-2971	72	SEG2	3474	640	112	SEG42	1293	2963
28	C1	1869	-2971	73	SEG3	3474	720	113	SEG43	1213	2963
29	V5OUT2	2005	-2971	74	SEG4	3474	801	114	SEG44	1132	2963
30	V5OUT2	2141	-2971	75	SEG5	3474	882	115	SEG45	1051	2963
31	V5OUT2	2277	-2971	76	SEG6	3474	963	116	SEG46	970	2963
32	V5OUT3	2413	-2971	77	SEG7	3474	1043	117	SEG47	890	2963
33	V5OUT3	2549	-2971	78	SEG8	3474	1124	118	SEG48	809	2963
34	V5	2685	-2971	79	SEG9	3474	1205	119	SEG49	728	2963
35	V5	2821	-2971	80	SEG10	3474	1286	120	SEG50	647	2963
36	V5	2957	-2971	81	SEG11	3474	1366	121	SEG51	567	2963
37	V4	3093	-2971	82	SEG12	3474	1447	122	SEG52	488	2963
38	V4	3229	-2971	83	SEG13	3474	1528	123	SEG53	405	2963
—	dummy4	3474	-2971	84	SEG14	3474	1609	124	SEG54	324	2963
—	dummy5	3474	-2699	85	SEG15	3474	1689	125	SEG55	244	2963
39	V3	3474	-2563	86	SEG16	3474	1770	126	SEG56	163	2963
40	V3	3474	-2427	87	SEG17	3474	1851	127	SEG57	82	2963
41	V2	3474	-2291	88	SEG18	3474	1932	128	SEG58	1	2963
42	V2	3474	-2155	89	SEG19	3474	2012	129	SEG59	-79	2963
43	V1	3474	-2019	90	SEG20	3474	2093	130	SEG60	-160	2963
44	V1	3474	-1883	91	SEG21	3474	2174	131	SEG61	-241	2963

Pin No.	Function	Coordinate		Pin No.	Function	Coordinate		Pin No.	Function	Coordinate	
		X	Y			X	Y			X	Y
132	SEG62	-322	2963	158	SEG88	-3474	2728	191	COM21	-3474	-17
133	SEG63	-402	2963	159	SEG89	-3474	2647	192	COM22	-3474	-98
134	SEG64	-483	2963	160	SEG90	-3474	2567	193	COM23	-3474	-179
135	SEG65	-564	2963	161	SEG91	-3474	2486	194	COM24	-3474	-260
136	SEG66	-645	2963	162	SEG92	-3474	2405	195	COM25	-3474	-340
137	SEG67	-725	2963	163	SEG93	-3474	2324	196	COM26	-3474	-421
138	SEG68	-806	2963	164	SEG94	-3474	2244	197	COM27	-3474	-502
139	SEG69	-887	2963	165	SEG95	-3474	2163	198	COM28	-3474	-583
140	SEG70	-968	2963	166	SEG96	-3474	2082	199	COM29	-3474	-663
141	SEG71	-1048	2963	167	SEG97	-3474	2001	200	COM30	-3474	-744
142	SEG72	-1129	2963	168	SEG98	-3474	1921	201	COM31	-3474	-825
143	SEG73	-1210	2963	169	SEG99	-3474	1840	202	COM32	-3474	-906
144	SEG74	-1291	2963	170	SEG100	-3474	1759	203	COM33	-3474	-986
145	SEG75	-1371	2963	171	SEG101	-3474	1678	204	COM34	-3474	-1067
146	SEG76	-1452	2963	172	SEG102	-3474	1598	205	COM35	-3474	-1148
147	SEG77	-1533	2963	173	SEG103	-3474	1517	206	COM36	-3474	-1229
148	SEG78	-1614	2963	174	SEG104	-3474	1436	207	COM37	-3474	-1309
149	SEG79	-1694	2963	175	SEG105	-3474	1355	208	COM38	-3474	-1390
150	SEG80	-1775	2963	176	SEG106	-3474	1275	209	COM39	-3474	-1471
151	SEG81	-1856	2963	177	SEG107	-3474	1194	210	COM40	-3474	-1552
152	SEG82	-1937	2963	178	SEG108	-3474	1113	211	COM41	-3474	-1632
153	SEG83	-2017	2963	179	SEG109	-3474	1032	212	COM42	-3474	-1713
154	SEG84	-2098	2963	180	SEG110	-3474	952	213	COM43	-3474	-1794
155	SEG85	-2179	2963	181	SEG111	-3474	871	214	COM44	-3474	-1875
156	SEG86	-2260	2963	182	SEG112	-3474	79	215	COM45	-3474	-1955
157	SEG87	-2340	2963	183	SEG113	-3474	709	216	COM53	-3474	-2036
—	dummy13	-2522	3027	184	SEG114	-3474	629	217	V _{CC}	-3474	-2169
—	dummy14	-2658	3027	185	SEG115	-3474	548	218	V _{CC}	-3474	-2305
—	dummy15	-2794	3027	186	SEG116	-3474	467	219	V _{CC}	-3474	-2441
—	dummy16	-2930	3027	187	SEG117	-3474	386	220	V _{CC}	-3474	-2577
—	dummy17	-3066	3027	188	SEG118	-3474	306	221	V _{CC}	-3474	-2713
—	dummy18	-3202	3027	189	SEG119	-3474	225	—	dymmy2	-3474	-2984
—	dummy1	-3474	3027	190	COM20	-3474	63				

Pin Function (HD66730)**Table 1 Pin Functional Description**

Signal	Number of Pins	I/O	Device Interfaced with	Function
RESET*	1	I	—	Acts as a reset input pin. The LSI is initialized during low level. Refer to Reset Function. Must be reset after power-on.
IM	1	I	—	Selects interface mode with the MPU; Low: Serial mode High: 8-bit bus mode
RS/CS*	1	I	MPU	Selects registers during bus mode: Low: Index register (write); Status register (read) High: Control register (write); RAM data (read/write) Acts as chip-select during serial mode: Low: Select (access enable) High: Not selected (access disable)
R \bar{W} /SID	1	I	MPU	Selects read/write during bus mode; Low: Write High: Read Inputs serial data during serial mode.
E/SCLK	1	I	MPU	Starts data read/write during bus mode; Inputs (Receives) serial clock during serial mode.
DB1 to DB7	7	I/O	MPU	Seven high-order bidirectional tristate data bus pins. Used for data transfer between the MPU and the HD66730. DB7 can be used as a busy flag. Open these pins during serial mode since these signals are not used.
DB0/ SOD	1	I/O /O	MPU	The lowest bidirectional data bit (DB0) during bus mode. Outputs (transmits) serial data during serial mode. Open this pin if reading (transmission) is not performed.
SEG1 to SEG71	71	O	LCD	Display data output signals for the segment extension driver.
COMS	1	O	LCD	Acts as a common output signal for segment display. Used to display icon and marks beside the character display.
COM1 to COM24	24	O	LCD	Acts as common output signals for character display. COM15 to COM24 become non-selective waveforms when the duty ratio is 1/14.
COM25/ COMD	1	O	LCD/ extension driver	Acts as common output signal (COM25) for character display when EXT2 bit is 0. Acts as a common extension pulse signal (COMD) when EXT2 bit is 1. The pin is grounded after RESET input is cleared. When this signal is used as COMD, GND \geq V5 must be maintained.

Table 1 Pin Functional Description (cont. HD66730)

Signal	Number of Pins	I/O	Device Interfaced with	Function
CL1	1	O	Extension driver	Outputs the latch pulse of segment extension driver. Can also be used as a shift clock of common extension driver. Enters tristate when both EXT1 and EXT2 are 0.
CL2	1	O	Extension driver	Outputs shift clock of segment extension driver. Can also be used as a common extension driver latch clock. Enters tristate when both EXT1 and EXT2 are 0.
SEGD	1	O	Extension driver	Outputs data of extension driver. Data after the 72nd dot is output. Enters tristate when EXT1 bit is 0.
M	1	O	Extension driver	Acts as an alternating current signal of extension driver. Enters tristate when both EXT1 and EXT2 bits are 0.
V1 to V5	5	—	Power supply	Power supply for LCD drive $V_{CC} - V5 = 15V$ (max)
V_{CC} /GND	2	—	Power supply	V_{CC} : +2.4V to +5.5V, GND: 0V
OSC1/ OSC2	2	—	Oscillation resistor/ clock	When crystal oscillation is performed, an external resistor must be connected. When the pin input is an external clock, it must be input to OSC1.
Vci	1	I	—	Inputs voltage to the booster to generate the liquid crystal display drive voltage. Vci is reference voltage and power supply for the booster. $V_{ci}: 1.0V \text{ to } 5.0V \leq V_{CC}$.
V5OUT2	1	O	V5 pin/ booster capacitor	Voltage input to the Vci pin is boosted twice and output. When the voltage is boosted three times, a capacitor with the same capacitance as that of C1–C2 should be connected here.
V5OUT3	1	O	V5 pin	Voltage input to the Vci pin is boosted three times and output.
C1/C2	2	—	Booster capacitor	External capacitor should be connected here when using the booster.

Pin Function (HD66731)**Table 2 Pin Functional Description**

Signal	Number of Pins	I/O	Device Interfaced with	Function
RESET*	1	I	—	Acts as a reset input pin. The LSI is initialized during low level. Refer to Reset Function. Must be reset after power-on.
IM	1	I	—	Selects interface mode with the MPU; Low: Serial mode High: 8-bit bus mode
RS/CS*	1	I	MPU	Selects registers during bus mode: Low: Index register (write); Status register (read) High: Control register (write); RAM data (read/write) Acts as chip-select during serial mode: Low: Select (access enable) High: Not selected (access disable)
R \bar{W} /SID	1	I	MPU	Selects read/write during bus mode; Low: Write High: Read Inputs serial data during serial mode.
E/SCLK	1	I	MPU	Starts data read/write during bus mode; Inputs (Receives) serial clock during serial mode.
DB1 to DB7	7	I/O	MPU	Seven high-order bidirectional tristate data bus pins. Used for data transfer between the MPU and the HD66731. DB7 can be used as a busy flag. Open these pins during serial mode since these signals are not used.
DB0/ SOD	1	I/O /O	MPU	The lowest bidirectional data bit (DB0) during bus mode. Outputs (transmits) serial data during serial mode. Open this pin if reading (transmission) is not performed.
SEG1 to SEG119	119	O	LCD	Display data output signals for the segment extension driver.
COMS	1	O	LCD	Acts as a common output signal for segment display. Used to display icon and marks beside the character display.
COM1 to COM51	51	O	LCD	Acts as common output signals for character display. COM14 acts as same as COMS when 1/14 duty. COM27 acts as same as COMS when 1/27 duty. COM40 acts as same as COMS when 1/40 duty. Unused common pins output non-selective waveforms.
COM53	1	O	LCD	Acts as common output signal for segment display when 1/53 duty. The waveform is same as coms. This COM53 outputs non-selective waveform when another duty.

Table 2 Pin Functional Description (cont. HD66731)

Signal	Number of Pins	I/O	Device Interfaced with	Function
V1 to V5	5	—	Power supply	Power supply for LCD drive $V_{CC} - V5 = 15V$ (max)
V_{CC} /GND	2	—	Power supply	V_{CC} : +2.4V to +5.5V, GND: 0V
OSC1/ OSC2	2	—	Oscillation resistor/ clock	When crystal oscillation is performed, an external resistor must be connected. When the pin input is an external clock, it must be input to OSC1.
Vci	1	I	—	Inputs voltage to the booster to generate the liquid crystal display drive voltage. Vci is reference voltage and power supply for the booster. $V_{ci}: 1.0V \text{ to } 5.0V \leq V_{CC}$.
V5OUT2	1	O	V5 pin/ booster capacitor	Voltage input to the Vci pin is boosted twice and output. When the voltage is boosted three times, a capacitor with the same capacitance as that of C1–C2 should be connected here.
V5OUT3	1	O	V5 pin	Voltage input to the Vci pin is boosted three times and output.
C1/C2	2	—	Booster capacitor	External capacitor should be connected here when using the booster.
TESTD	1	O	—	Test pin. Must be left disconnected.
Dummy1 to Dummy18	18	—	—	Dummy pads. These pads are electrically floating level.

Function Description

System Interface

The HD66730/1 has two system interfaces: a synchronized serial one and an 8-bit bus. Both are selected by the IM pin.

The HD66730/1 has five types of 8-bit registers: an index register (IDR), status register (STR), various control registers, RAM address register (RAR), and RAM data register (RDR).

The index register (IDR) selects control registers, the RAM address register (RAR) or the RAM data register (RDR) for performing data transfer.

The status register (STR) indicates the internal state of the system. Various control registers store display control data here.

The RAM address register (RAR) stores the address data of display data RAM (DDRAM), character generator RAM (CGRAM), and segment RAM (SEGRAM).

The RAM data register (RDR) temporarily stores data to be written into DDRAM, CGRAM, or SEGRAM. Data written into the RDR from the MPU is automatically written into DDRAM, CGRAM, or SEGRAM by internal operations. The RDR is also used for data storage when reading data from DDRAM, CGRAM, or SEGRAM. Here, when address information is written into the RAR, data is read and then stored into the RDR from DDRAM, CGRAM, or SEGRAM by internal operations.

Data transfer between the MPU is then completed when the MPU reads the RDR. After this read, data in DDRAM, CGRAM, or SEGRAM stored at the next address is sent to the RDR at the next data read from the MPU.

These registers can be selected by the register select signal (RS) and the read/write signal (R/W) in the 8-bit bus interface, and by the RS bit and R/W bit of start-byte data in the synchronized serial interface.

Busy Flag

When the busy flag is 1, the HD66730/1 is in internal operation mode, and only the status register (STR) can be accessed. The busy flag (BF) is output from bit 7 (DB7). Access of other registers can be performed only after confirming that the busy flag is 0.

RAM Address Counter (RAR)

The RAM address counter (RAR) provides addresses for accessing DDRAM, CGRAM, or SEGRAM. When an initial address value is written into the RAM counter (RAR), the RAR is automatically incremented or decremented by 1. Note that a control register specifies which RAM (DDRAM, CGRAM, SEGRAM) to select.

Table 3 Register Selection

RS	R/\bar{W}	Operation
0	0	IDR write
0	1	STR read
1	0	Control register write, RAM address register (RAR) write, and RAM data register (RDR) write
1	1	RAM data register (RDR) read

Display Data RAM (DDRAM)

Display data RAM (DDRAM) stores character codes and display attribute codes for displaying data.

A full-size font is displayed using two bytes, and a half-size font is displayed using one byte. Since the RAM capacity is 80 bytes, 40 full-size characters or 80 half-size characters can be stored.

DDRAM displays only that data stored within the range corresponding to the number of display columns. Data stored outside the range is ignored. Refer to Combined Display of Full-Size and Half-Size characters for details on character codes stored in DDRAM. The relationship between DDRAM addresses and LCD display position depends on the number of display lines (1 line/2 lines/4 lines).

Execution of the display-clear instruction writes H'A0 corresponding to the half-size character for "space" throughout DDRAM.

Note: The HD66730/1 performs display by reading character codes from the DDRAM according to the number of display columns set by the control register. In particular, reading from the DDRAM begins at the position corresponding to the rightmost character as set by the maximum number of display columns. This means that one byte of a two-byte full-size character code should not be set in a position exceeding the maximum number of display columns. For example, do not write a full-size code (2 bytes) in the 12th and 13th byte when the display is set for six characters.

- 1-line display (NL1/0 = 00)

80 bytes of consecutive addresses from H'00 to H'4F are allocated for DDRAM addresses. When there are fewer than 40 display characters (at full size), only the number of display characters specified by NC1/0 are displayed starting from H'00 in the DDRAM. For example, 12 bytes of addresses from H'00 to H'0B are used when a 6-character display (NC1/0 = 00) is performed using one HD66730; addresses from H'0C on are ignored. In this case, do not write a full-size code into bytes H'0B and H'0C because a half-size character may be displayed. See Figure 1 for a 1-line display.

- 2-line display (NL1/0 = 01)

The first line in the DDRAM address is displayed for the 40 bytes of addresses from H'00 to H'27, and the second line is displayed for the 40 bytes of addresses from H'40 to H'67. When there are fewer than 20 display characters (at full size), only the number of display characters specified by NC1/0 will be displayed starting from the leftmost address of the DDRAM. For example, 24 bytes of addresses from H'00 to H'0B and H'40 to H'4B are used when a 6-character display (NC1/0 = 00) is performed using one HD66730. Addresses from H'0C and H'4C on are ignored. See Figure 2 for a 2-line display.

- 4-line display (NL1/0 = 11)

The first line in the DDRAM address is displayed from H'00 to H'13, the second line from H'20 to H'33, the third line from H'40 to H'53, and the fourth line from H'60 to H'73. For a 6-character display (NC1/0 = 00) (at full-size), only 12 bytes from the leftmost address of DDRAM are displayed. See Figure 3 for a 4-line display.

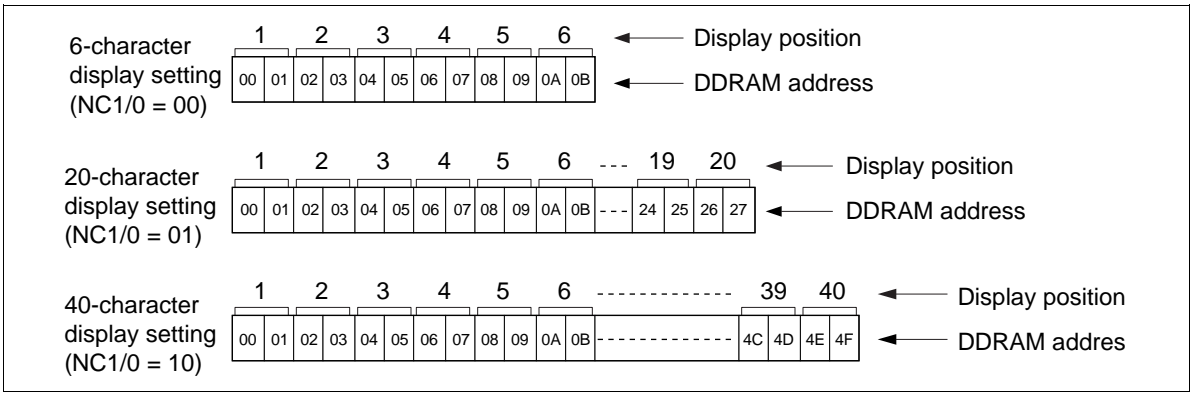

Figure 1 1-Line Display (NL1/0 = 00)

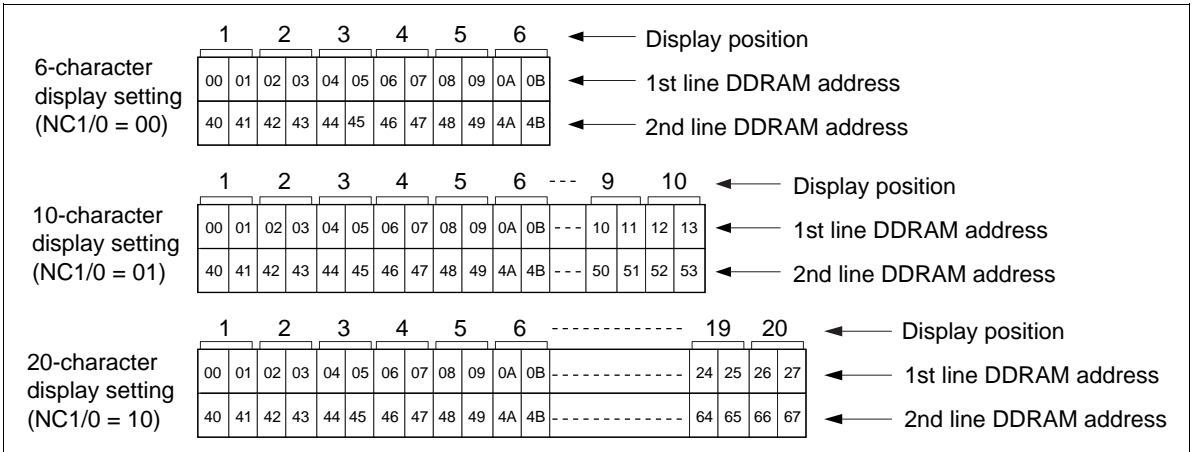

Figure 2 2-Line Display (NL1/0 = 01)

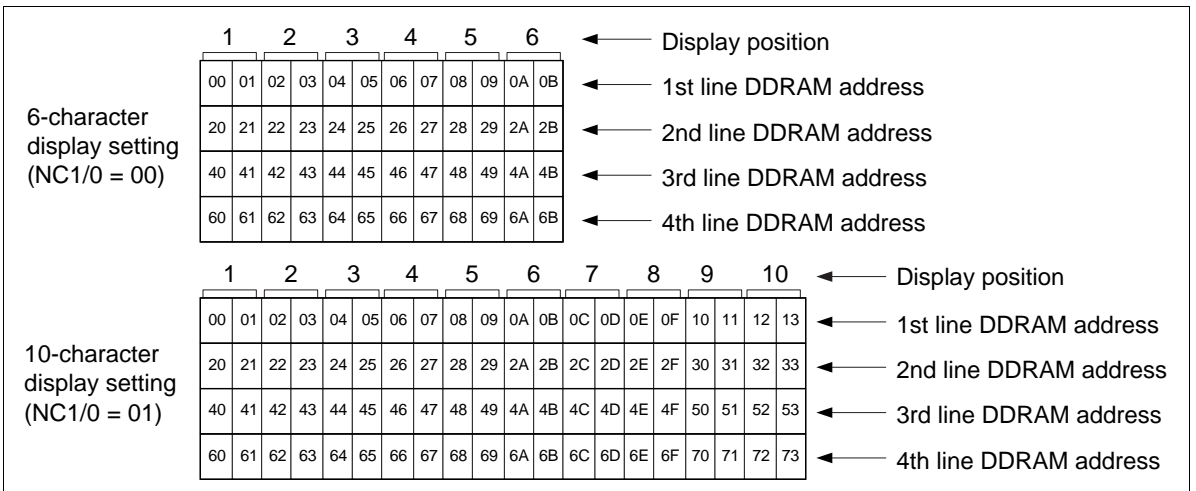

Figure 3 4-Line Display (NL1/0 = 11)

Character Generator ROM for a Full-Size Font (FCGROM)

The character generator ROM for a full-size font (FCGROM) generates 3,840 11×12 dot full-size character patterns from a 12-bit character code. This includes 2,965 kanji according to the JIS Level-1 Kanji Set and 524 JIS non-kanji. Table 4 shows the relationship between character codes set in DDRAM and full-size font patterns. Refer to Combined Display of Full-Size and Half-Size Characters for the relationship between JIS codes and the character codes to be set in the DDRAM.

Character Generator ROM for a Half-Size Font (HCGROM)

The character generator ROM for a half-size font (HCGROM) generates 128 6×12 dot character patterns from 7-bit character codes. A half-size font (alphanumeric characters and symbols) can be displayed together with a full-size font. Refer to Combined Display of Full-Size and Half-Size Characters for details.

Character Generator RAM (CGRAM)

The character generator RAM (CGRAM) allows the user to display arbitrary full-size font patterns. It can display 8 12×13 dot fonts.

This RAM can also display double-size characters and figures by combining multiple CGRAM fonts. Specify character codes from H'000 to H'007 in a full size of character code when displaying font patterns stored in the CGRAM.

Segment RAM (SEGRAM)

The segment RAM (SEGRAM) is used to control icons and marks in segment units by the user program. Bits in SEGRAM corresponding to segments to be displayed are directly set by the MPU, regardless of the contents of DDRAM and CGRAM. The SEGRAM is read and displayed when the COMS output pin is selected.

Up to 71 icons can be displayed using a single HD66730. Up to 96 icons can be displayed by expanding the drivers on the segment side. SEGRAM data is stored in eight bits. The lower six bits control the display of each segment, and the upper two bits control segment blinking.

HD66731 can display 96 icons without the expanding driver.

Timing Generator

The timing generator generates timing signals for the operation of internal circuits such as DDRAM, FCGROM, HCGROM, CGRAM, and SEGRAM. RAM read timing for display and internal operation timing for MPU access are generated separately to avoid interference. This prevents undesirable interferences, such as flickering, in areas other than the display area when writing data to DDRAM, for example.

The timing generator of HD66730 generates interface control signals CL1, CL2, M, and COMD-output of extension drivers for a extension configuration.

Display Attribute Controller

The display attribute controller displays white/black inverse, blinking, and white/black inverse blinking for a full size font in FCGROM according to the attribute code set in the DDRAM. Refer to Display Attribute Designation for details.

Fonts in CGRAM and bit patterns in SEGRAM control display attributes using the upper two bits (bits 7 and 6) in each display-pattern data.

Cursor Control Circuit

The cursor control circuit is used to produce a cursor on a displayed character corresponding to the DDRAM address set in the RAM address counter (RAR). Cursors can be chosen from three types: 12th raster-row cursor that is displayed only on the 12th raster-row of each font; blink cursor that periodically displays the whole font in black and white and black inverted cursor that periodically displays the font in white and black (see Figure 9). Note that when the RAM address counter (RAR) is selecting CGRAM or SEGRAM, a cursor would be generated at that address, however, it does not have any meaning.

Note: One display line consists of 13 raster-rows.

Smooth Scroll Control Circuit

The smooth scroll control circuit is used to perform a smooth-scroll in units of dots.

When the number of characters to be displayed is greater than that possible at one time in the liquid crystal module, this horizontal smooth scroll can be used to display characters in an easy-to-read manner for each line. Refer to Horizontal Smooth Scroll for details for each line.

Liquid Crystal Display Driver Circuit

The liquid crystal display driver circuit of HD66730 consists of 26 common signal drivers and 71 segment signal drivers. HD66731 has 54 common signal drivers and 119 segment signal drivers. When the liquid crystal driver duty ratio is set by a program, the necessary common signal drivers output drive waveforms and the remaining common drivers output non-selected waveforms. In addition, drivers can be expanded on the common and segment sides through register settings.

Display pattern data is sent serially through a shift register and latched when all needed data has arrived. The latched data then enables the LCD driver to generate drive waveform outputs. This serial data is sent from the display pattern that corresponds to the last address of the DDRAM and is latched when the character pattern of the display data corresponding to the first address enters the internal shift register.

Booster

The booster outputs a voltage that is two or three times higher than the reference voltage input from pin Vci. Since the LCD voltage can be generated from the LSI operation power supply, this circuit can operate with a single power supply. Refer to Power Supply for Liquid Crystal Display Drive for details.

Oscillator

The HD66730/1 performs R-C oscillation by adding a single external oscillation resistor. The oscillation frequency corresponding to display size and frame frequency can be adjusted by changing the oscillation resistor. Refer to Oscillator for details.

Table 4 Relationship between Full-Size Character Code and Kanji

Upper / Lower	0	1	2	3	4	5	6	7	8	9	A	B	C	D	E	F
0 2	井	垂	唾	娃	阿	哀	愛	挨	始	逢	葵	茜	穉	惡	握	渥
0 3	旭	葦	芦	鯁	梓	庄	幹	拔	宛	姐	虻	飴	絢	綾	鮎	或
0 4	粟	裕	安	庵	按	暗	案	闇	鞍	杏	以	伊	位	依	偉	圃
0 5	夷	委	威	尉	惟	意	慰	易	椅	為	畏	異	移	維	緯	胃
0 6	萎	衣	謂	違	遺	医	井	支	域	育	郁	磯	一	老	溢	逸
0 7	稻	茨	芋	鰯	允	印	咽	員	因	姻	引	飲	淫	胤	蔭	嬰
0 A	昂	院	陰	隱	韻	吋	右	宇	烏	羽	迂	雨	卯	鸚	窺	丑
0 B	確	白	渦	嘘	唄	蔚	蔚	鰻	姥	既	迂	浦	瓜	閏	嗜	云
0 C	雲	荏	餌	叡	營	嬰	影	映	曳	榮	永	泳	洩	瑛	盈	穎
0 D	穎	英	衛	詠	銳	液	疫	益	馱	悅	謁	越	閏	榎	厭	円
0 E	園	堰	奄	宴	延	怨	掩	援	沿	演	炎	焰	煙	燕	猿	縁
0 F	艶	苑	園	遠	鉛	鴛	塩	於	汚	甥	凹	央	奧	往	応	苺
1 2	葺	押	旺	橫	欧	殿	王	翁	襖	鶯	鸚	黃	岡	沖	萩	億
1 3	屋	憶	臆	桶	壯	乙	俺	卸	恩	温	穩	音	下	化	仮	何
1 4	伽	価	佳	加	可	嘉	夏	嫁	家	寡	科	暇	果	架	歌	河
1 5	火	珂	禍	禾	稼	箇	花	苛	茄	荷	華	菓	蝦	課	嘩	貨
1 6	迦	過	霞	蚊	俄	峨	我	廻	牙	画	臥	芽	蛾	賀	餓	駕
1 7	介	会	解	回	塊	壞	廻	快	怪	悔	恢	懷	戒	拐	改	効
1 A	洩	魁	晦	械	海	灰	界	皆	繪	芥	街	蟹	開	階	凱	効
1 B	外	咳	害	崖	慨	概	涯	碍	蓋	芥	街	該	鎧	骸	馨	蛙
1 C	垣	柿	蛎	鈎	劃	嚇	各	廊	拈	攪	格	核	殼	獲	確	穫
1 D	覚	角	赫	較	郭	閣	隔	革	学	岳	樂	額	頸	掛	笠	橙
1 E	櫃	梶	鯀	渴	割	喝	恰	括	活	渴	滑	葛	褐	轄	且	鱉
1 F	叶	枇	樺	鞆	株	兜	竈	蒲	釜	鎌	嚙	鴨	栢	茅	萱	苺
2 2	澤	粥	刈	苜	瓦	乾	侃	冠	寒	刊	勘	勸	卷	喚	堪	姦
2 3	完	官	寬	干	幹	患	感	慣	憾	換	敢	柑	垣	棺	款	歛
2 4	汗	漢	澗	灌	環	甘	監	看	竿	管	簡	緩	缶	翰	肝	艦
2 5	莞	觀	諫	貫	還	鑑	問	閑	閑	陷	韓	館	館	丸	含	岸
2 6	蔽	玩	癌	眼	岩	甌	贗	雁	頑	顏	願	企	伎	危	喜	器
2 7	基	奇	嬉	寄	岐	希	幾	忌	揮	机	旗	既	期	棋	棄	起
2 A	萌	機	婦	毅	気	汽	畿	祈	季	稀	紀	徽	規	記	貴	起
2 B	軌	輝	飢	騎	鬼	龜	偽	儀	妓	宜	戲	技	擬	欺	儀	疑
2 C	祇	義	蟻	誼	議	拘	菊	鞠	吉	吃	喫	桔	橘	詰	砧	杵
2 D	祇	求	汲	脚	泣	逆	丘	久	仇	休	及	吸	宮	弓	急	救
2 E	朽	求	汲	脚	泣	逆	丘	久	仇	休	及	吸	宮	弓	急	居
2 F	巨	拒	扼	拳	渠	虛	許	距	鋸	漁	禦	魚	亨	享	京	強
3 2	葦	供	俠	僑	兇	競	共	凶	協	匡	卿	叫	喬	境	峽	強
3 3	彊	怯	恐	恭	扶	教	橋	況	狂	狹	矯	胸	脅	輿	喬	鄉
3 4	鏡	響	饗	驚	仰	凝	堯	曉	業	局	曲	極	玉	桐	杆	僅
3 5	勤	均	巾	錦	斤	欣	欽	琴	禁	禽	筋	聚	芹	蘭	衿	襟
3 6	謹	近	金	吟	銀	九	俱	句	區	狗	玖	矩	苦	軀	驅	駢
3 7	駒	具	愚	虞	喰	空	偶	寓	遇	隅	串	櫛	屑	屈	君	君
3 A	莉	掘	窟	沓	靴	響	窪	熊	隈	象	栗	繰	桑	歛	勲	君
3 B	薰	訓	群	軍	郡	卦	袈	邗	係	傾	刑	兄	啓	圭	珪	型
3 C	契	形	徑	惠	慶	慧	憩	揭	携	敬	景	桂	溪	畦	稽	系
3 D	經	繼	繫	罍	莖	荊	螢	計	詣	警	輕	預	鷄	芸	迎	鯨
3 E	劇	戟	擊	激	隙	桁	傑	欠	決	潔	穴	結	血	訣	月	件
3 F	俟	倦	健	兼	券	劍	喧	園	堅	嫌	建	憲	懸	拳	捲	拳

Table 4 Relationship between Full-Size Character Code and Kanji (cont)

Upper / Lower	0	1	2	3	4	5	6	7	8	9	A	B	C	D	E	F
4 2	計	檢	權	牽	犬	獻	研	硯	絹	梟	肩	見	謙	賢	軒	遣
4 3	鍵	險	顛	驗	骸	元	原	嚴	幻	姑	減	源	玄	現	絃	舛
4 4	言	諺	限	乎	個	古	呼	固	孀	跨	己	庫	弧	戶	故	枯
4 5	湖	狐	糊	袴	股	胡	菰	虎	誇	跨	鉗	屨	顧	鼓	五	互
4 6	伍	午	吳	吾	娛	後	御	悟	梧	檣	瑚	碁	語	誤	護	醐
4 7	乞	鯉	交	佼	侯	候	倖	光	公	功	効	勾	厚	口	向	宥
4 A	隄	后	喉	坑	垢	好	孔	孝	宏	工	巧	巷	幸	広	庚	康
4 B	弘	恒	慌	抗	拘	控	攻	昂	晃	更	杭	校	梗	構	江	洪
4 C	浩	港	溝	甲	皇	硬	稿	糠	紅	絃	絞	綱	耕	考	肯	肱
4 D	腔	膏	航	荒	行	衡	講	貢	購	郊	醇	鉦	砢	鋼	閣	降
4 E	項	香	高	鴻	剛	劫	号	合	壕	拷	濠	豪	轟	趨	克	刻
4 F	告	国	穀	酷	鵠	黑	獄	漉	腰	甌	忽	惚	骨	狛	込	馱
5 2	餃	此	項	今	困	坤	墾	婚	恨	懇	昏	昆	根	梱	混	痕
5 3	紺	艮	魂	些	佐	又	峻	曠	左	差	查	沙	瑤	砂	詐	鎖
5 4	裘	坐	座	挫	債	催	再	最	哉	塞	妻	宰	彩	才	採	裁
5 5	歲	濟	災	采	犀	碎	碧	祭	齋	細	菜	裁	載	際	劑	在
5 6	材	罪	財	冚	坂	阪	堺	柵	肴	咲	崎	埼	碕	鷺	作	削
5 7	詐	榨	昨	朔	柵	窄	策	索	錯	桜	鮭	笹	匙	冊	刷	晒
5 A	与	察	撈	撮	擦	札	殺	薩	雜	阜	鯖	捌	鏑	鮫	皿	晒
5 B	三	酸	傘	參	山	慘	撒	散	燦	珊	產	算	纂	蚕	讚	贊
5 C	酸	餐	斬	暫	殘	仕	散	伺	使	刺	司	史	嗣	四	士	始
5 D	姉	姿	子	屍	市	師	志	思	指	支	孜	斯	旨	枝	止	誌
5 E	死	氏	獅	祉	私	糸	紙	紫	肢	脂	至	視	詞	詩	試	誌
5 F	諮	資	賜	雌	飼	齒	事	似	侍	兒	字	寺	慈	持	時	誌
6 2	式	次	滋	治	爾	聖	痔	磁	示	而	耳	自	蒔	辭	汐	鹿
6 3	式	識	鳴	竺	軸	穴	零	七	叱	執	失	嫉	室	悉	湿	漆
6 4	疾	質	寔	蔀	篠	偲	柴	芝	屢	藥	稿	舍	写	射	捨	赦
6 5	斜	煮	社	紗	者	謝	車	遮	蛇	邪	借	勺	尺	杓	灼	爵
6 6	酌	积	錫	若	寂	弱	惹	主	取	守	手	朱	殊	狩	珠	種
6 7	腫	趣	酒	首	儒	受	呪	寿	授	樹	綬	需	囚	収	周	蒐
6 A	丸	宗	就	州	修	愁	拾	洲	秀	秋	終	繡	習	臭	舟	蒐
6 B	衆	龔	讐	蹴	輯	週	酋	酬	集	醜	什	住	充	十	徒	戎
6 C	柔	汁	洪	獸	縱	重	銃	叔	夙	宿	淑	祝	縮	肅	塾	熟
6 D	出	術	述	俊	峻	春	瞬	竣	舜	駿	准	循	旬	楯	殉	淳
6 E	準	潤	盾	純	巡	遵	醇	順	屺	初	所	暑	曙	渚	庶	緒
6 F	署	書	薯	諸	諸	助	叙	女	序	徐	恕	鋤	除	傷	償	少
7 2	暑	勝	匠	升	召	哨	商	唱	嘗	獎	妾	娼	宵	將	小	少
7 3	尚	庄	床	廠	彰	承	抄	招	掌	捷	昇	昌	昭	晶	松	梢
7 4	樟	樵	沼	消	涉	湘	燒	焦	照	症	省	硝	礁	祥	称	章
7 5	笑	粧	紹	肖	莒	蔣	蕉	衝	裳	訟	証	詔	詳	象	賞	醬
7 6	鉦	鍾	鐘	障	鞘	上	丈	丞	乘	冗	刺	城	場	壤	娘	常
7 7	情	擾	条	杖	淨	狀	疊	穰	蒸	讓	釀	錠	囑	埴	飾	侵
7 A	唇	拭	植	殖	燭	織	職	色	觸	食	蝕	辱	尻	伸	信	侵
7 B	唇	娠	寢	審	心	慎	振	新	晉	森	榛	浸	深	申	疹	真
7 C	神	秦	紳	臣	芯	薪	親	診	身	辛	進	針	震	人	仁	刃
7 D	塵	壬	尋	甚	尽	腎	訊	迅	陣	靱	筍	詼	須	醉	冏	厨
7 E	逗	吹	垂	帥	推	水	炊	睡	粹	翠	衰	遂	醉	錘	隨	隨
7 F	瑞	髓	崇	嵩	數	樞	趨	雛	据	杉	梠	菅	頗	雀	裾	裾

Table 4 Relationship between Full-Size Character Code and Kanji (cont)

Upper / Lower	0	1	2	3	4	5	6	7	8	9	A	B	C	D	E	F
8 2	口	澄	摺	寸	世	瀬	畝	是	凄	制	勢	姓	征	性	成	政
8 3	整	星	晴	樓	栖	正	清	是	生	盛	精	聖	声	製	西	誠
8 4	誓	請	逝	籍	青	靜	赤	稅	脆	隻	席	惜	戚	斥	昔	析
8 5	石	積	籜	績	脊	責	齊	跡	躡	雙	切	拙	接	撰	折	設
8 6	窃	節	說	雪	絕	舌	蟬	仙	蹟	千	占	拙	專	撰	川	戰
8 7	扇	撰	栓	梅	泉	淺	洗	染	先	煎	扇	旋	穿	箭	線	戰
8 A	口	織	羨	腺	舛	船	薦	詮	賤	踐	選	遷	錢	銑	閃	鮮
8 B	前	善	漸	然	全	禪	繕	膳	糲	嚼	塑	蛆	措	曾	曾	楚
8 C	狙	疏	疎	礎	祖	租	粗	素	組	蘇	訴	阻	遡	鼠	僧	創
8 D	双	叢	倉	喪	壯	奏	爽	宋	層	匠	惣	想	搜	掃	挿	搔
8 E	操	早	曹	巢	槍	槽	漕	燥	争	瘦	相	窓	槽	総	綜	聡
8 F	草	莊	葬	蒼	藻	裝	走	送	遭	鎗	霜	騷	像	増	憎	送
9 2	仁	臧	藏	贈	造	促	側	則	即	息	捉	束	測	足	速	俗
9 3	属	賊	族	統	卒	袖	其	揃	存	孫	尊	損	村	遜	他	多
9 4	太	汰	詫	唾	墮	妥	情	打	柁	舵	構	陀	駄	驛	体	堆
9 5	对	耐	岱	帶	待	怠	態	戴	替	泰	滯	胎	腿	苔	袋	貸
9 6	退	逮	隊	黛	鯛	代	台	大	第	醒	題	鷹	滝	瀧	卓	啄
9 7	宅	托	扞	拓	沢	濯	琢	託	鐸	濁	諾	茸	風	蛸	只	秘
9 A	叩	但	達	辰	奪	脫	異	豎	迪	棚	谷	狸	鱈	樽	誰	誰
9 B	丹	单	嘆	坦	担	探	旦	歎	淡	湛	炭	短	端	筭	綻	耽
9 C	胆	蛋	誕	鍛	团	壇	彈	斷	暖	暹	段	男	談	值	知	地
9 D	逐	秩	窒	池	嫡	着	置	致	蚰	遲	馳	畜	注	虫	衷	衷
9 F	註	耐	鑄	駐	櫛	瀦	猪	苜	著	貯	丁	兆	洩	喋	寵	寵
A 2	幽	帖	帳	庁	弔	張	彫	徵	懲	挑	暢	朝	潮	牒	町	眺
A 3	聽	脹	腸	蝶	調	諜	超	跳	眺	挑	長	頂	鳥	勅	抄	朕
A 4	沈	珍	質	鎮	陳	津	墜	椎	槌	追	鎚	痛	通	塚	拇	摺
A 5	槻	佃	漬	柘	辻	薦	綴	鏢	椿	潰	坪	壺	嬌	袖	爪	吊
A 6	釣	鶴	亭	低	停	偵	刺	貞	呈	堤	定	帝	底	庭	廷	弟
A 7	佛	抵	挺	提	梯	汀	碇	禎	程	締	艇	訂	諦	蹄	遞	弟
AA	圃	邸	鄭	釘	鼎	泥	摘	擢	敵	滴	的	笛	適	鎬	溺	哲
AB	徹	撤	轍	迭	鉄	典	填	天	展	店	添	纏	甜	貼	軛	顛
AC	点	伝	殿	澁	田	電	兔	吐	堵	塗	妬	屠	徒	斗	杜	渡
AD	登	菟	賭	途	都	鍍	砥	砺	努	度	土	奴	怒	倒	党	冬
AE	凍	刀	唐	塔	塘	套	宕	烏	鳴	悼	投	搭	東	桃	袴	棟
AF	盜	淘	湯	涛	灯	燈	当	痘	捧	等	答	筒	糖	統	到	棟
B 2	盜	董	蕩	藤	討	騰	豆	踏	童	透	鎧	陶	頭	騰	闕	働
B 3	動	同	蕩	導	憧	撞	洞	瞳	童	詭	苟	道	頭	峠	鴉	匿
B 4	得	德	澆	特	督	禿	毒	獨	敦	詭	栃	橡	凸	突	楸	屈
B 5	鳶	苦	寅	酉	諱	噸	屯	惇	敦	沌	豚	遁	頓	吞	曇	鈍
B 6	奈	那	内	乍	凧	難	謎	灘	捺	鍋	楮	馴	繩	暇	南	楠
B 7	軟	難	汝	二	尼	弍	迹	匂	脈	肉	虹	廿	日	乳	入	入
BA	三	如	尿	菲	任	妊	忍	認	濡	襴	祢	寧	葱	猫	熱	年
BB	念	捻	撚	燃	粘	乃	迺	之	棼	囊	惱	濃	納	能	腦	膿
BC	農	視	蚤	巴	把	播	霸	杷	波	派	琶	破	婆	罵	芭	馬
BD	俳	癡	拜	排	敗	杯	盃	牌	背	肺	輩	配	倍	培	媒	梅
BE	株	煤	狽	買	壳	賠	陪	這	蠅	秤	矧	菽	伯	剥	博	拍
BF	柏	泊	白	箔	柏	舶	薄	迫	曝	爆	縛	縛	莫	駁	麥	麥

Table 4 Relationship between Full-Size Character Code and Kanji (cont)

Upper / Lower	0	1	2	3	4	5	6	7	8	9	A	B	C	D	E	F
C 2	𠄎	函	箱	俗	箸	肇	筭	櫛	幡	肌	畑	阜	八	鉢	澆	癸
C 3	醜	髮	伐	罰	拔	筏	閱	鳩	嘶	塙	蛤	隼	伴	判	半	反
C 4	叛	帆	搬	斑	板	汎	汎	版	犯	班	畔	繁	般	藩	販	範
C 5	采	煩	頒	飯	挽	晚	番	盤	磐	蕃	蚤	匪	卑	否	妃	庇
C 6	彼	悲	扉	批	披	斐	比	泌	疲	皮	碑	秘	緋	罷	肥	被
C 7	費	費	避	紐	飛	樋	簸	備	尾	微	枇	毘	毳	眉	美	𠄎
CA	𠄎	鼻	柎	稗	匹	疋	髭	膝	麥	肘	彌	必	票	畢	筆	逼
CB	桧	姬	媛	紉	百	謬	俄	彪	標	水	漂	瓢	必	畢	評	約
CC	廟	描	病	秒	苗	鏽	蒜	蛭	鱈	品	彬	斌	浜	灑	貧	𠄎
CD	賓	頻	敏	瓶	不	付	埠	夫	婦	富	富	布	府	怖	扶	敷
CE	斧	普	浮	父	符	腐	膚	芙	譜	負	賦	赴	阜	附	侮	撫
CF	武	舞	葡	蕪	部	封	楓	風	葺	落	伏	副	復	幅	服	𠄎
D 2	𠄎	福	腹	複	覆	淵	弗	弘	沸	仏	物	耐	分	吻	噴	墳
D 3	憤	扮	焚	奮	粉	糞	紛	雰	文	閒	丙	併	兵	塀	幣	平
D 4	弊	柄	並	蔽	閉	陛	米	頁	僻	壁	癖	碧	別	警	蔑	篋
D 5	偏	變	片	篇	編	辺	返	遍	便	勉	婉	弁	鞭	保	鋪	鋪
D 6	圃	捕	步	甫	補	輔	穗	募	墓	慕	戊	暮	母	簿	菩	倣
D 7	俸	包	呆	報	奉	宝	峰	峯	崩	庖	抱	捧	放	方	朋	𠄎
DA	𠄎	法	泡	烹	砲	縫	胞	芳	萌	蓬	蜂	喪	訪	豐	邦	鋒
DB	飽	鳳	鵬	乏	亡	傍	剖	坊	妨	帽	忘	忙	房	暴	望	某
DC	棒	冒	紡	肪	膨	謀	貌	貿	鉞	防	吠	頰	北	僕	卜	墨
DD	撲	朴	牧	睦	穆	釦	勃	沒	殆	堀	幌	奔	本	翻	凡	盆
DE	摩	磨	魔	麻	埋	妹	昧	沫	每	埋	襪	幕	枕	凡	餉	枉
DF	鱒	樹	亦	侯	又	抹	昧	末	迄	俣	密	蔭	膜	慢	滿	𠄎
E 2	𠄎	漫	蔓	味	未	魅	巳	箕	岬	俣	密	蔭	膜	慢	滿	𠄎
E 3	耗	民	眠	務	夢	無	牟	矛	霧	鶻	棕	婿	娘	冥	名	命
E 4	明	盟	迷	銘	鳴	姪	牝	滅	免	棉	綿	緬	面	麵	摸	模
E 5	茂	妄	孟	毛	猛	盲	網	耗	蒙	儲	木	默	目	李	勿	餅
E 6	尤	戾	初	貫	問	悶	紋	門	匆	也	冶	夜	爺	耶	野	弥
E 7	矢	厄	役	約	葉	詛	躍	靖	柳	菽	鏈	愉	愈	油	癒	𠄎
EA	𠄎	論	輸	唯	佑	優	勇	友	宥	幽	悠	憂	揖	有	柚	湧
EB	涌	猶	猷	由	祐	裕	誘	遊	邑	郵	雄	融	夕	予	余	与
EC	譽	輿	預	傭	幼	妖	容	庸	揚	搖	擁	曜	楊	樣	洋	溶
ED	熔	用	窯	羊	耀	葉	蓉	要	謠	踊	遙	陽	養	慾	抑	欲
EE	沃	浴	翌	翼	淀	羅	螺	裸	來	萊	賴	雷	洛	絡	落	酪
EF	乱	卵	嵐	欄	盪	藍	蘭	覽	利	吏	履	李	梨	理	璃	溜
F 2	𠄎	痢	裏	裡	里	離	陸	律	率	立	律	掠	略	劉	流	溜
F 3	琉	留	琉	粒	隆	竜	龍	侶	慮	旅	虜	了	亮	僚	兩	凌
F 4	寮	料	梁	涼	胤	療	瞭	稜	懼	良	諒	遼	量	陵	領	力
F 5	綠	寮	倫	厘	林	淋	琳	臨	禮	隣	鱗	隸	隴	淚	累	麗
F 6	類	令	伶	列	劣	勵	嶺	伶	禮	禮	鈴	鍊	鍊	練	聯	𠄎
F 7	齡	曆	歷	列	劣	烈	嶺	伶	禮	禮	鈴	鍊	鍊	練	聯	𠄎
FA	𠄎	蓮	連	鍊	呂	魯	櫓	炉	賂	路	露	勞	婁	廊	弄	朗
FB	樓	榔	浪	漏	牢	狼	篋	老	壘	蠟	郎	六	麓	祿	肋	錄
FC	論	倭	和	話	歪	賄	脇	惑	粹	鶯	互	巨	鰐	詭	藁	葦
FD	椀	灣	碗	腕	𠄎	𠄎	𠄎	𠄎	𠄎	𠄎	𠄎	𠄎	𠄎	𠄎	𠄎	𠄎
FE	I	II	III	IV	V	VI	VII	VIII	IX	X	XI	XII	⊙	⊙	⊙	⊙
FF	i	ii	iii	iv	v	vi	vii	viii	ix	x	xi	xii	⊙	⊙	⊙	⊙

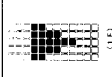





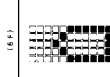

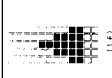
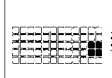



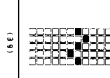

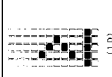



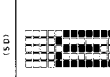

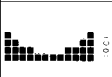
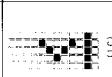
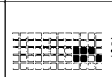
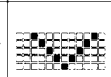
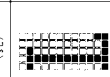
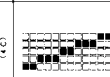
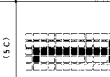
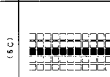

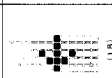
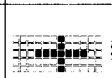
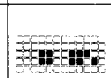
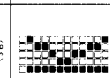
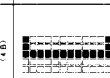
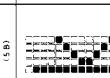

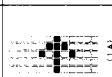
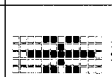
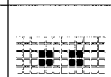
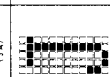
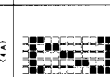
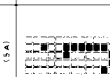
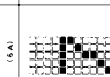
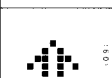
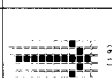
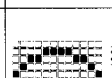
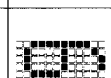
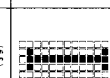
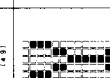
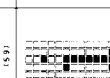

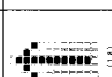
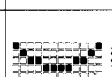
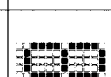
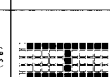

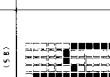

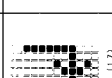
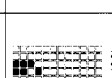
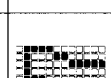

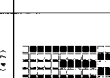



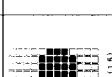

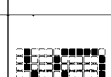

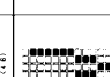
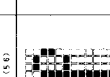

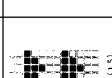

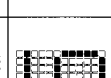

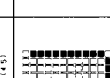

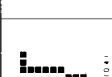
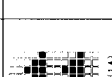

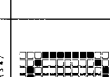

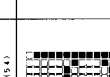
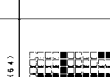
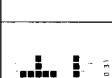
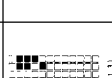
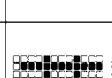





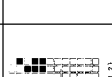
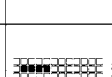



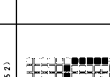

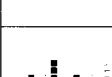
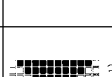

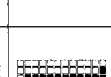

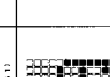

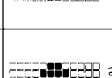



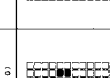

Table 5 Relationship between Full-Size Character Code and Non-Kanji

Upper/Lower	0	1	2	3	4	5	6	7	8	9	A	B	C	D	E	F
4 8		ˆ	˘	ˇ	˙	˚	˛	˜	˝	?	!	ˆ	˘	ˇ	˙	˚
4 9		ˆ	˘	ˇ	˙	˚	˛	˜	˝	全	々	ノ	〇	一	一	ノ
8 8	ノ	˜	≡	ノ	˘	˙	˚	“	”	([]	[]
8 9	ノ	ノ	ノ	ノ	ノ	ノ	ノ	ノ	ノ	ノ	ノ	ノ	ノ	ノ	ノ	ノ
C 8	÷	=	≠	<	>	≤	≥	∞	∴	♂	♀	°	′	″	±	×
C 9	\$	¢	£	%	#	&	*	@	§	☆	★	○	●	◎	◇	¥
5 0	♣	◆	□	■	△	▲	▽	▼	※	〒	→	←	↑	↓	=	≠
5 1	↗	↖	↙	↘	⊕	⊖	⊗	⊘	⊙	⊚	⊛	⊜	⊝	⊞	⊟	⊠
9 0	U	∩	∪	∩	∪	∩	∪	∩	∪	∩	∪	∩	∪	∩	∪	∩
9 1	∩	∪	∩	∪	∩	∪	∩	∪	∩	∪	∩	∪	∩	∪	∩	∪
D 0	∇	≡	≠	<	>	√	∞	∞	∴	f	ff	〒	⊕	⊖	⊗	⊘
D 1	ノ	ノ	À	%	#	b	ノ	†	‡	¶	ち	⊕	⊖	⊗	⊘	⊙
5 8	⊕	⊖	⊗	⊘	⊙	⊚	⊛	⊜	⊝	⊞	⊟	⊠	⊡	⊢	⊣	⊤
5 9	0	1	2	3	4	5	6	7	8	9	10	11	12	13	14	15
9 8	ノ	A	B	C	D	E	F	G	H	I	J	K	L	M	N	O
9 9	P	Q	R	S	T	U	V	W	X	Y	Z	⊕	⊖	⊗	⊘	⊙
D 8	ノ	a	b	c	d	e	f	g	h	i	j	k	l	m	n	o
D 9	p	q	r	s	t	u	v	w	x	y	z	⊕	⊖	⊗	⊘	⊙
6 0	ノ	あ	あ	い	い	う	う	え	え	お	お	か	が	き	ぎ	く
6 1	だ	け	げ	こ	ご	さ	ざ	し	じ	す	ず	か	が	き	ぎ	く
A 0	だ	け	ち	こ	つ	づ	て	で	と	す	な	に	ぬ	ね	の	た
A 1	ば	ぱ	ひ	び	び	ふ	ぶ	ぶ	へ	べ	べ	に	ほ	ほ	の	ま
E 0	む	め	も	ゃ	ゃ	ゅ	ゅ	よ	よ	ら	り	る	れ	ろ	わ	わ
E 1	ゐ	ゑ	を	ん	ゑ	ゑ	ゑ	ゑ	ゑ	ゑ	ゑ	ゑ	ゑ	ゑ	ゑ	ゑ
6 8	ノ	ア	ア	イ	イ	ウ	ウ	エ	エ	オ	オ	カ	ガ	キ	ギ	ク
6 9	グ	ケ	ゲ	コ	ゴ	サ	ザ	シ	ジ	ス	ズ	セ	ゼ	ソ	ゾ	タ
A 8	ダ	チ	ヂ	ッ	ツ	ヅ	テ	デ	ト	ド	ナ	ニ	ヌ	ネ	ノ	ハ
A 9	バ	パ	ヒ	ビ	ピ	フ	ブ	プ	ヘ	ベ	ペ	ホ	ボ	ポ	マ	ミ
E 8	ム	メ	モ	ヤ	ヤ	ユ	ユ	ヨ	ヨ	ラ	リ	ル	レ	ロ	ワ	ワ
E 9	キ	エ	ヲ	ン	ヴ	カ	ケ	16	17	18	19	20	21	22	23	24
7 0	ノ	A	B	Γ	Δ	E	Ζ	H	Θ	I	K	Λ	M	N	Ξ	O
7 1	Π	P	Σ	T	Υ	Φ	X	Ψ	Ω	Δ	Δ	Δ	Δ	Δ	Δ	Δ
B 0	α	β	γ	δ	ε	ζ	η	θ	ι	κ	λ	μ	ν	ξ	ο	
B 1	π	ρ	σ	τ	υ	φ	χ	ψ	ω	α	α	α	α	α	α	
F 0	Α	Α	Α	Β	Γ	Δ	Ε	Ζ	Η	Θ	Ι	Κ	Λ	Μ	Ν	
F 1	α	β	γ	δ	ε	ζ	η	θ	ι	κ	λ	μ	ν	ξ	ο	
7 8	ノ	A	B	В	Г	Д	E	Ё	Ж	З	И	Й	К	Л	М	Н
7 9	О	П	Р	С	Т	У	Ф	Х	Ц	Ч	Ш	Щ	Ъ	Ы	Ь	Э
B 8	Ю	Я	и	с	т	у	ф	х	ц	ч	ш	щ	ъ	ы	ь	э
B 9	ю	я	и	с	т	у	ф	х	ц	ч	ш	щ	ъ	ы	ь	э
F 8	о	п	р	с	т	у	ф	х	ц	ч	ш	щ	ъ	ы	ь	э
F 9	ю	я	и	с	т	у	ф	х	ц	ч	ш	щ	ъ	ы	ь	э
4 0		—		┌	┐	└	┘	┌	┐	└	┘	┌	┐	└	┘	┌
4 1	┌	┐	└	┘	┌	┐	└	┘	┌	┐	└	┘	┌	┐	└	┘
8 0	+	+	=	+	+	+	+	+	+	+	+	+	+	+	+	+
8 1	+	+	+	+	+	+	+	+	+	+	+	+	+	+	+	+
C 0	+	+	+	+	+	+	+	+	+	+	+	+	+	+	+	+
C 1	+	+	+	+	+	+	+	+	+	+	+	+	+	+	+	+

Table 6 Relationship between Half-Size Character Code and Character Pattern
(ROM Code: A00)

Upper (4 bits) Lower (3 bits)	0000	0001	0010	0011	0100	0101	0110	0111	1000	1001	1010	1011	1100	1101	1110	1111
xxxx 000					(Space)											
xxxx 001																
xxxx 010																
xxxx 011																
xxxx 100																
xxxx 101																
xxxx 110																
xxxx 111																

HD66730/731 A01 Korean font set (KS C 5601-1992 subset)

◆ Hitachi Font 2024.04.25

HD66730/HD66731

HD66730/731 A01 Korean font set (KS C 5601-1992 subset)

Full Font Unicode Map 000 - 07F

0000	0001	0002	0003	0004	0005	0006	0007	0008	0009	000A	000B	000C	000D	000E	000F	0010	0011	0012	0013	0014	0015	0016	0017	0018	0019	001A	001B	001C	001D	001E	001F
0020	0021	0022	0023	0024	0025	0026	0027	0028	0029	002A	002B	002C	002D	002E	002F	0030	0031	0032	0033	0034	0035	0036	0037	0038	0039	003A	003B	003C	003D	003E	003F
0040	0041	0042	0043	0044	0045	0046	0047	0048	0049	004A	004B	004C	004D	004E	004F	0050	0051	0052	0053	0054	0055	0056	0057	0058	0059	005A	005B	005C	005D	005E	005F
0060	0061	0062	0063	0064	0065	0066	0067	0068	0069	006A	006B	006C	006D	006E	006F	0070	0071	0072	0073	0074	0075	0076	0077	0078	0079	007A	007B	007C	007D	007E	007F

HD66730/731 A01 Korean font set (KS C 5601-1992 subset)

(0800)	(0801)	(0802)	(0803)	(0804)	(0805)	(0806)	(0807)	(0808)	(0809)	(0810)	(0811)	(0812)	(0813)	(0814)	(0815)	(0816)	(0817)	(0818)	(0819)	(0820)	(0821)	(0822)	(0823)	(0824)	(0825)	(0826)	(0827)	(0828)	(0829)	(0830)	(0831)	(0832)	(0833)	(0834)	(0835)	(0836)	(0837)	(0838)	(0839)	(0840)	(0841)	(0842)	(0843)	(0844)	(0845)	(0846)	(0847)	(0848)	(0849)	(0850)	(0851)	(0852)	(0853)	(0854)	(0855)	(0856)	(0857)	(0858)	(0859)	(0860)	(0861)	(0862)	(0863)	(0864)	(0865)	(0866)	(0867)	(0868)	(0869)	(0870)	(0871)	(0872)	(0873)	(0874)	(0875)	(0876)	(0877)	(0878)	(0879)	(0880)	(0881)	(0882)	(0883)	(0884)	(0885)	(0886)	(0887)	(0888)	(0889)	(0890)	(0891)	(0892)	(0893)	(0894)	(0895)	(0896)	(0897)	(0898)	(0899)	(0900)	(0901)	(0902)	(0903)	(0904)	(0905)	(0906)	(0907)	(0908)	(0909)	(0910)	(0911)	(0912)	(0913)	(0914)	(0915)	(0916)	(0917)	(0918)	(0919)	(0920)	(0921)	(0922)	(0923)	(0924)	(0925)	(0926)	(0927)	(0928)	(0929)	(0930)	(0931)	(0932)	(0933)	(0934)	(0935)	(0936)	(0937)	(0938)	(0939)	(0940)	(0941)	(0942)	(0943)	(0944)	(0945)	(0946)	(0947)	(0948)	(0949)	(0950)	(0951)	(0952)	(0953)	(0954)	(0955)	(0956)	(0957)	(0958)	(0959)	(0960)	(0961)	(0962)	(0963)	(0964)	(0965)	(0966)	(0967)	(0968)	(0969)	(0970)	(0971)	(0972)	(0973)	(0974)	(0975)	(0976)	(0977)	(0978)	(0979)	(0980)	(0981)	(0982)	(0983)	(0984)	(0985)	(0986)	(0987)	(0988)	(0989)	(0990)	(0991)	(0992)	(0993)	(0994)	(0995)	(0996)	(0997)	(0998)	(0999)
--------	--------	--------	--------	--------	--------	--------	--------	--------	--------	--------	--------	--------	--------	--------	--------	--------	--------	--------	--------	--------	--------	--------	--------	--------	--------	--------	--------	--------	--------	--------	--------	--------	--------	--------	--------	--------	--------	--------	--------	--------	--------	--------	--------	--------	--------	--------	--------	--------	--------	--------	--------	--------	--------	--------	--------	--------	--------	--------	--------	--------	--------	--------	--------	--------	--------	--------	--------	--------	--------	--------	--------	--------	--------	--------	--------	--------	--------	--------	--------	--------	--------	--------	--------	--------	--------	--------	--------	--------	--------	--------	--------	--------	--------	--------	--------	--------	--------	--------	--------	--------	--------	--------	--------	--------	--------	--------	--------	--------	--------	--------	--------	--------	--------	--------	--------	--------	--------	--------	--------	--------	--------	--------	--------	--------	--------	--------	--------	--------	--------	--------	--------	--------	--------	--------	--------	--------	--------	--------	--------	--------	--------	--------	--------	--------	--------	--------	--------	--------	--------	--------	--------	--------	--------	--------	--------	--------	--------	--------	--------	--------	--------	--------	--------	--------	--------	--------	--------	--------	--------	--------	--------	--------	--------	--------	--------	--------	--------	--------	--------	--------	--------	--------	--------	--------	--------	--------	--------	--------	--------	--------	--------	--------	--------	--------	--------	--------	--------	--------	--------

HD66730/HD66731

HD66730/731 A01 Korean font set (KS C 5601-1992 subset)

(100)	(101)	(102)	(103)	(104)	(105)	(106)	(107)	(108)	(109)	(110)	(111)	(112)	(113)	(114)	(115)	(116)	(117)	(118)	(119)	(120)	(121)	(122)	(123)	(124)	(125)	(126)	(127)	(128)	(129)	(130)	(131)	(132)	(133)	(134)	(135)	(136)	(137)	(138)	(139)	(140)	(141)	(142)	(143)	(144)	(145)	(146)	(147)	(148)	(149)	(150)	(151)	(152)	(153)	(154)	(155)	(156)	(157)	(158)	(159)	(160)	(161)	(162)	(163)	(164)	(165)	(166)	(167)	(168)	(169)	(170)	(171)	(172)	(173)	(174)	(175)	(176)	(177)	(178)	(179)	(180)	(181)	(182)	(183)	(184)	(185)	(186)	(187)	(188)	(189)	(190)	(191)	(192)	(193)	(194)	(195)	(196)	(197)	(198)	(199)
-------	-------	-------	-------	-------	-------	-------	-------	-------	-------	-------	-------	-------	-------	-------	-------	-------	-------	-------	-------	-------	-------	-------	-------	-------	-------	-------	-------	-------	-------	-------	-------	-------	-------	-------	-------	-------	-------	-------	-------	-------	-------	-------	-------	-------	-------	-------	-------	-------	-------	-------	-------	-------	-------	-------	-------	-------	-------	-------	-------	-------	-------	-------	-------	-------	-------	-------	-------	-------	-------	-------	-------	-------	-------	-------	-------	-------	-------	-------	-------	-------	-------	-------	-------	-------	-------	-------	-------	-------	-------	-------	-------	-------	-------	-------	-------	-------	-------	-------	-------

Font: HD66730, HD66731, HD66732, HD66733, HD66734, HD66735, HD66736, HD66737, HD66738, HD66739, HD66740, HD66741, HD66742, HD66743, HD66744, HD66745, HD66746, HD66747, HD66748, HD66749, HD66750, HD66751, HD66752, HD66753, HD66754, HD66755, HD66756, HD66757, HD66758, HD66759, HD66760, HD66761, HD66762, HD66763, HD66764, HD66765, HD66766, HD66767, HD66768, HD66769, HD66770, HD66771, HD66772, HD66773, HD66774, HD66775, HD66776, HD66777, HD66778, HD66779, HD66780, HD66781, HD66782, HD66783, HD66784, HD66785, HD66786, HD66787, HD66788, HD66789, HD66790, HD66791, HD66792, HD66793, HD66794, HD66795, HD66796, HD66797, HD66798, HD66799

HD66730/731 A01 Korean font set (KS C 5601-1992 subset)

Full-Font Code Map 186 - 1FF

		가 (180)	나 (181)	다 (182)	라 (183)	사 (184)	아 (185)	야 (186)	에 (187)	오 (188)	우 (189)	유 (190)	이 (191)	이 (192)	이 (193)	이 (194)	이 (195)	이 (196)	이 (197)	이 (198)	이 (199)
		가 (1A0)	나 (1A1)	다 (1A2)	라 (1A3)	사 (1A4)	아 (1A5)	야 (1A6)	에 (1A7)	오 (1A8)	우 (1A9)	유 (1AA)	이 (1AB)	이 (1AC)	이 (1AD)	이 (1AE)	이 (1AF)	이 (1AG)	이 (1AH)	이 (1AI)	이 (1AJ)
		가 (1B0)	나 (1B1)	다 (1B2)	라 (1B3)	사 (1B4)	아 (1B5)	야 (1B6)	에 (1B7)	오 (1B8)	우 (1B9)	유 (1BA)	이 (1BB)	이 (1BC)	이 (1BD)	이 (1BE)	이 (1BF)	이 (1BG)	이 (1BH)	이 (1BI)	이 (1BJ)
		가 (1C0)	나 (1C1)	다 (1C2)	라 (1C3)	사 (1C4)	아 (1C5)	야 (1C6)	에 (1C7)	오 (1C8)	우 (1C9)	유 (1CA)	이 (1CB)	이 (1CC)	이 (1CD)	이 (1CE)	이 (1CF)	이 (1CG)	이 (1CH)	이 (1CI)	이 (1CJ)
		가 (1D0)	나 (1D1)	다 (1D2)	라 (1D3)	사 (1D4)	아 (1D5)	야 (1D6)	에 (1D7)	오 (1D8)	우 (1D9)	유 (1DA)	이 (1DB)	이 (1DC)	이 (1DD)	이 (1DE)	이 (1DF)	이 (1DG)	이 (1DH)	이 (1DI)	이 (1DJ)
		가 (1E0)	나 (1E1)	다 (1E2)	라 (1E3)	사 (1E4)	아 (1E5)	야 (1E6)	에 (1E7)	오 (1E8)	우 (1E9)	유 (1EA)	이 (1EB)	이 (1EC)	이 (1ED)	이 (1EE)	이 (1EF)	이 (1EG)	이 (1EH)	이 (1EI)	이 (1EJ)
		가 (1F0)	나 (1F1)	다 (1F2)	라 (1F3)	사 (1F4)	아 (1F5)	야 (1F6)	에 (1F7)	오 (1F8)	우 (1F9)	유 (1FA)	이 (1FB)	이 (1FC)	이 (1FD)	이 (1FE)	이 (1FF)	이 (1FG)	이 (1FH)	이 (1FI)	이 (1FJ)

HD66730/HD66731

HD66730/731 A01 Korean font set (KS C 5601-1992 subset)

Font Name: HD66730	Character Code: (2000)	Character: (2000)	Character Code: (2001)	Character: (2001)	Character Code: (2002)	Character: (2002)	Character Code: (2003)	Character: (2003)
	(2004)	(2004)	(2005)	(2005)	(2006)	(2006)	(2007)	(2007)
	(2008)	(2008)	(2009)	(2009)	(200A)	(200A)	(200B)	(200B)
	(200C)	(200C)	(200D)	(200D)	(200E)	(200E)	(200F)	(200F)
	(2010)	(2010)	(2011)	(2011)	(2012)	(2012)	(2013)	(2013)
	(2014)	(2014)	(2015)	(2015)	(2016)	(2016)	(2017)	(2017)
	(2018)	(2018)	(2019)	(2019)	(201A)	(201A)	(201B)	(201B)
	(201C)	(201C)	(201D)	(201D)	(201E)	(201E)	(201F)	(201F)
	(2020)	(2020)	(2021)	(2021)	(2022)	(2022)	(2023)	(2023)
	(2024)	(2024)	(2025)	(2025)	(2026)	(2026)	(2027)	(2027)
	(2028)	(2028)	(2029)	(2029)	(202A)	(202A)	(202B)	(202B)
	(202C)	(202C)	(202D)	(202D)	(202E)	(202E)	(202F)	(202F)
	(2030)	(2030)	(2031)	(2031)	(2032)	(2032)	(2033)	(2033)
	(2034)	(2034)	(2035)	(2035)	(2036)	(2036)	(2037)	(2037)
	(2038)	(2038)	(2039)	(2039)	(203A)	(203A)	(203B)	(203B)
	(203C)	(203C)	(203D)	(203D)	(203E)	(203E)	(203F)	(203F)
	(2040)	(2040)	(2041)	(2041)	(2042)	(2042)	(2043)	(2043)
	(2044)	(2044)	(2045)	(2045)	(2046)	(2046)	(2047)	(2047)
	(2048)	(2048)	(2049)	(2049)	(204A)	(204A)	(204B)	(204B)
	(204C)	(204C)	(204D)	(204D)	(204E)	(204E)	(204F)	(204F)
	(2050)	(2050)	(2051)	(2051)	(2052)	(2052)	(2053)	(2053)
	(2054)	(2054)	(2055)	(2055)	(2056)	(2056)	(2057)	(2057)
	(2058)	(2058)	(2059)	(2059)	(205A)	(205A)	(205B)	(205B)
	(205C)	(205C)	(205D)	(205D)	(205E)	(205E)	(205F)	(205F)
	(2060)	(2060)	(2061)	(2061)	(2062)	(2062)	(2063)	(2063)
	(2064)	(2064)	(2065)	(2065)	(2066)	(2066)	(2067)	(2067)
	(2068)	(2068)	(2069)	(2069)	(206A)	(206A)	(206B)	(206B)
	(206C)	(206C)	(206D)	(206D)	(206E)	(206E)	(206F)	(206F)
	(2070)	(2070)	(2071)	(2071)	(2072)	(2072)	(2073)	(2073)
	(2074)	(2074)	(2075)	(2075)	(2076)	(2076)	(2077)	(2077)
	(2078)	(2078)	(2079)	(2079)	(207A)	(207A)	(207B)	(207B)
	(207C)	(207C)	(207D)	(207D)	(207E)	(207E)	(207F)	(207F)
	(2080)	(2080)	(2081)	(2081)	(2082)	(2082)	(2083)	(2083)
	(2084)	(2084)	(2085)	(2085)	(2086)	(2086)	(2087)	(2087)
	(2088)	(2088)	(2089)	(2089)	(208A)	(208A)	(208B)	(208B)
	(208C)	(208C)	(208D)	(208D)	(208E)	(208E)	(208F)	(208F)
	(2090)	(2090)	(2091)	(2091)	(2092)	(2092)	(2093)	(2093)
	(2094)	(2094)	(2095)	(2095)	(2096)	(2096)	(2097)	(2097)
	(2098)	(2098)	(2099)	(2099)	(209A)	(209A)	(209B)	(209B)
	(209C)	(209C)	(209D)	(209D)	(209E)	(209E)	(209F)	(209F)
	(20A0)	(20A0)	(20A1)	(20A1)	(20A2)	(20A2)	(20A3)	(20A3)
	(20A4)	(20A4)	(20A5)	(20A5)	(20A6)	(20A6)	(20A7)	(20A7)
	(20A8)	(20A8)	(20A9)	(20A9)	(20AA)	(20AA)	(20AB)	(20AB)
	(20AC)	(20AC)	(20AD)	(20AD)	(20AE)	(20AE)	(20AF)	(20AF)
	(20B0)	(20B0)	(20B1)	(20B1)	(20B2)	(20B2)	(20B3)	(20B3)
	(20B4)	(20B4)	(20B5)	(20B5)	(20B6)	(20B6)	(20B7)	(20B7)
	(20B8)	(20B8)	(20B9)	(20B9)	(20BA)	(20BA)	(20BB)	(20BB)
	(20BC)	(20BC)	(20BD)	(20BD)	(20BE)	(20BE)	(20BF)	(20BF)
	(20C0)	(20C0)	(20C1)	(20C1)	(20C2)	(20C2)	(20C3)	(20C3)
	(20C4)	(20C4)	(20C5)	(20C5)	(20C6)	(20C6)	(20C7)	(20C7)
	(20C8)	(20C8)	(20C9)	(20C9)	(20CA)	(20CA)	(20CB)	(20CB)
	(20CC)	(20CC)	(20CD)	(20CD)	(20CE)	(20CE)	(20CF)	(20CF)
	(20D0)	(20D0)	(20D1)	(20D1)	(20D2)	(20D2)	(20D3)	(20D3)
	(20D4)	(20D4)	(20D5)	(20D5)	(20D6)	(20D6)	(20D7)	(20D7)
	(20D8)	(20D8)	(20D9)	(20D9)	(20DA)	(20DA)	(20DB)	(20DB)
	(20DC)	(20DC)	(20DD)	(20DD)	(20DE)	(20DE)	(20DF)	(20DF)
	(20E0)	(20E0)	(20E1)	(20E1)	(20E2)	(20E2)	(20E3)	(20E3)
	(20E4)	(20E4)	(20E5)	(20E5)	(20E6)	(20E6)	(20E7)	(20E7)
	(20E8)	(20E8)	(20E9)	(20E9)	(20EA)	(20EA)	(20EB)	(20EB)
	(20EC)	(20EC)	(20ED)	(20ED)	(20EE)	(20EE)	(20EF)	(20EF)
	(20F0)	(20F0)	(20F1)	(20F1)	(20F2)	(20F2)	(20F3)	(20F3)
	(20F4)	(20F4)	(20F5)	(20F5)	(20F6)	(20F6)	(20F7)	(20F7)
	(20F8)	(20F8)	(20F9)	(20F9)	(20FA)	(20FA)	(20FB)	(20FB)
	(20FC)	(20FC)	(20FD)	(20FD)	(20FE)	(20FE)	(20FF)	(20FF)

HD66730/731 A01 Korean font set (KS C 5601-1992 subset)

(2800)	(2801)	(2802)	(2803)	(2804)	(2805)	(2806)	(2807)	(2808)	(2809)	(280A)	(280B)	(280C)	(280D)	(280E)	(280F)	(280G)	(280H)	(280I)	(280J)	(280K)	(280L)	(280M)	(280N)	(280O)	(280P)	(280Q)	(280R)	(280S)	(280T)	(280U)	(280V)	(280W)	(280X)	(280Y)	(280Z)
(2810)	(2811)	(2812)	(2813)	(2814)	(2815)	(2816)	(2817)	(2818)	(2819)	(281A)	(281B)	(281C)	(281D)	(281E)	(281F)	(281G)	(281H)	(281I)	(281J)	(281K)	(281L)	(281M)	(281N)	(281O)	(281P)	(281Q)	(281R)	(281S)	(281T)	(281U)	(281V)	(281W)	(281X)	(281Y)	(281Z)
(2820)	(2821)	(2822)	(2823)	(2824)	(2825)	(2826)	(2827)	(2828)	(2829)	(282A)	(282B)	(282C)	(282D)	(282E)	(282F)	(282G)	(282H)	(282I)	(282J)	(282K)	(282L)	(282M)	(282N)	(282O)	(282P)	(282Q)	(282R)	(282S)	(282T)	(282U)	(282V)	(282W)	(282X)	(282Y)	(282Z)
(2830)	(2831)	(2832)	(2833)	(2834)	(2835)	(2836)	(2837)	(2838)	(2839)	(283A)	(283B)	(283C)	(283D)	(283E)	(283F)	(283G)	(283H)	(283I)	(283J)	(283K)	(283L)	(283M)	(283N)	(283O)	(283P)	(283Q)	(283R)	(283S)	(283T)	(283U)	(283V)	(283W)	(283X)	(283Y)	(283Z)
(2840)	(2841)	(2842)	(2843)	(2844)	(2845)	(2846)	(2847)	(2848)	(2849)	(284A)	(284B)	(284C)	(284D)	(284E)	(284F)	(284G)	(284H)	(284I)	(284J)	(284K)	(284L)	(284M)	(284N)	(284O)	(284P)	(284Q)	(284R)	(284S)	(284T)	(284U)	(284V)	(284W)	(284X)	(284Y)	(284Z)
(2850)	(2851)	(2852)	(2853)	(2854)	(2855)	(2856)	(2857)	(2858)	(2859)	(285A)	(285B)	(285C)	(285D)	(285E)	(285F)	(285G)	(285H)	(285I)	(285J)	(285K)	(285L)	(285M)	(285N)	(285O)	(285P)	(285Q)	(285R)	(285S)	(285T)	(285U)	(285V)	(285W)	(285X)	(285Y)	(285Z)
(2860)	(2861)	(2862)	(2863)	(2864)	(2865)	(2866)	(2867)	(2868)	(2869)	(286A)	(286B)	(286C)	(286D)	(286E)	(286F)	(286G)	(286H)	(286I)	(286J)	(286K)	(286L)	(286M)	(286N)	(286O)	(286P)	(286Q)	(286R)	(286S)	(286T)	(286U)	(286V)	(286W)	(286X)	(286Y)	(286Z)
(2870)	(2871)	(2872)	(2873)	(2874)	(2875)	(2876)	(2877)	(2878)	(2879)	(287A)	(287B)	(287C)	(287D)	(287E)	(287F)	(287G)	(287H)	(287I)	(287J)	(287K)	(287L)	(287M)	(287N)	(287O)	(287P)	(287Q)	(287R)	(287S)	(287T)	(287U)	(287V)	(287W)	(287X)	(287Y)	(287Z)
(2880)	(2881)	(2882)	(2883)	(2884)	(2885)	(2886)	(2887)	(2888)	(2889)	(288A)	(288B)	(288C)	(288D)	(288E)	(288F)	(288G)	(288H)	(288I)	(288J)	(288K)	(288L)	(288M)	(288N)	(288O)	(288P)	(288Q)	(288R)	(288S)	(288T)	(288U)	(288V)	(288W)	(288X)	(288Y)	(288Z)
(2890)	(2891)	(2892)	(2893)	(2894)	(2895)	(2896)	(2897)	(2898)	(2899)	(289A)	(289B)	(289C)	(289D)	(289E)	(289F)	(289G)	(289H)	(289I)	(289J)	(289K)	(289L)	(289M)	(289N)	(289O)	(289P)	(289Q)	(289R)	(289S)	(289T)	(289U)	(289V)	(289W)	(289X)	(289Y)	(289Z)
(28A0)	(28A1)	(28A2)	(28A3)	(28A4)	(28A5)	(28A6)	(28A7)	(28A8)	(28A9)	(28AA)	(28AB)	(28AC)	(28AD)	(28AE)	(28AF)	(28AG)	(28AH)	(28AI)	(28AJ)	(28AK)	(28AL)	(28AM)	(28AN)	(28AO)	(28AP)	(28AQ)	(28AR)	(28AS)	(28AT)	(28AU)	(28AV)	(28AW)	(28AX)	(28AY)	(28AZ)
(28B0)	(28B1)	(28B2)	(28B3)	(28B4)	(28B5)	(28B6)	(28B7)	(28B8)	(28B9)	(28BA)	(28BB)	(28BC)	(28BD)	(28BE)	(28BF)	(28BG)	(28BH)	(28BI)	(28BJ)	(28BK)	(28BL)	(28BM)	(28BN)	(28BO)	(28BP)	(28BQ)	(28BR)	(28BS)	(28BT)	(28BU)	(28BV)	(28BW)	(28BX)	(28BY)	(28BZ)
(28C0)	(28C1)	(28C2)	(28C3)	(28C4)	(28C5)	(28C6)	(28C7)	(28C8)	(28C9)	(28CA)	(28CB)	(28CC)	(28CD)	(28CE)	(28CF)	(28CG)	(28CH)	(28CI)	(28CJ)	(28CK)	(28CL)	(28CM)	(28CN)	(28CO)	(28CP)	(28CQ)	(28CR)	(28CS)	(28CT)	(28CU)	(28CV)	(28CW)	(28CX)	(28CY)	(28CZ)
(28D0)	(28D1)	(28D2)	(28D3)	(28D4)	(28D5)	(28D6)	(28D7)	(28D8)	(28D9)	(28DA)	(28DB)	(28DC)	(28DD)	(28DE)	(28DF)	(28DG)	(28DH)	(28DI)	(28DJ)	(28DK)	(28DL)	(28DM)	(28DN)	(28DO)	(28DP)	(28DQ)	(28DR)	(28DS)	(28DT)	(28DU)	(28DV)	(28DW)	(28DX)	(28DY)	(28DZ)
(28E0)	(28E1)	(28E2)	(28E3)	(28E4)	(28E5)	(28E6)	(28E7)	(28E8)	(28E9)	(28EA)	(28EB)	(28EC)	(28ED)	(28EE)	(28EF)	(28EG)	(28EH)	(28EI)	(28EJ)	(28EK)	(28EL)	(28EM)	(28EN)	(28EO)	(28EP)	(28EQ)	(28ER)	(28ES)	(28ET)	(28EU)	(28EV)	(28EW)	(28EX)	(28EY)	(28EZ)
(28F0)	(28F1)	(28F2)	(28F3)	(28F4)	(28F5)	(28F6)	(28F7)	(28F8)	(28F9)	(28FA)	(28FB)	(28FC)	(28FD)	(28FE)	(28FF)	(28FG)	(28FH)	(28FI)	(28FJ)	(28FK)	(28FL)	(28FM)	(28FN)	(28FO)	(28FP)	(28FQ)	(28FR)	(28FS)	(28FT)	(28FU)	(28FV)	(28FW)	(28FX)	(28FY)	(28FZ)

Full-Font Case Map 280 - 2FA

HD66730/HD66731

HD66730/731 A01 Korean font set (KS C 5601-1992 subset)

가 (3100)	나 (3101)	다 (3102)	라 (3103)	마 (3104)	바 (3105)	사 (3106)	자 (3107)	차 (3108)	카 (3109)	타 (3110)	파 (3111)	하 (3112)	하 (3113)	하 (3114)	하 (3115)	하 (3116)	하 (3117)	하 (3118)	하 (3119)	하 (3120)	하 (3121)	하 (3122)	하 (3123)	하 (3124)	하 (3125)	하 (3126)	하 (3127)	하 (3128)	하 (3129)	하 (3130)	하 (3131)	하 (3132)	하 (3133)	하 (3134)	하 (3135)	하 (3136)	하 (3137)	하 (3138)	하 (3139)	하 (3140)	하 (3141)	하 (3142)	하 (3143)	하 (3144)	하 (3145)	하 (3146)	하 (3147)	하 (3148)	하 (3149)	하 (3150)	하 (3151)	하 (3152)	하 (3153)	하 (3154)	하 (3155)	하 (3156)	하 (3157)	하 (3158)	하 (3159)	하 (3160)	하 (3161)	하 (3162)	하 (3163)	하 (3164)	하 (3165)	하 (3166)	하 (3167)	하 (3168)	하 (3169)	하 (3170)	하 (3171)	하 (3172)	하 (3173)	하 (3174)	하 (3175)	하 (3176)	하 (3177)	하 (3178)	하 (3179)	하 (3180)	하 (3181)	하 (3182)	하 (3183)	하 (3184)	하 (3185)	하 (3186)	하 (3187)	하 (3188)	하 (3189)	하 (3190)	하 (3191)	하 (3192)	하 (3193)	하 (3194)	하 (3195)	하 (3196)	하 (3197)	하 (3198)	하 (3199)
-------------	-------------	-------------	-------------	-------------	-------------	-------------	-------------	-------------	-------------	-------------	-------------	-------------	-------------	-------------	-------------	-------------	-------------	-------------	-------------	-------------	-------------	-------------	-------------	-------------	-------------	-------------	-------------	-------------	-------------	-------------	-------------	-------------	-------------	-------------	-------------	-------------	-------------	-------------	-------------	-------------	-------------	-------------	-------------	-------------	-------------	-------------	-------------	-------------	-------------	-------------	-------------	-------------	-------------	-------------	-------------	-------------	-------------	-------------	-------------	-------------	-------------	-------------	-------------	-------------	-------------	-------------	-------------	-------------	-------------	-------------	-------------	-------------	-------------	-------------	-------------	-------------	-------------	-------------	-------------	-------------	-------------	-------------	-------------	-------------	-------------	-------------	-------------	-------------	-------------	-------------	-------------	-------------	-------------	-------------	-------------	-------------	-------------	-------------	-------------

HD66730/731 A01 Korean font set (KS C 5601-1992 subset)

Full-Font: C, G, M, J, Y, H		(3894)	(3895)	(3896)	(3897)	(3898)	(3899)
	(3894)	(3895)	(3896)	(3897)	(3898)	(3899)	(3900)
	(3901)	(3902)	(3903)	(3904)	(3905)	(3906)	(3907)
	(3908)	(3909)	(3910)	(3911)	(3912)	(3913)	(3914)
	(3915)	(3916)	(3917)	(3918)	(3919)	(3920)	(3921)
	(3922)	(3923)	(3924)	(3925)	(3926)	(3927)	(3928)
	(3929)	(3930)	(3931)	(3932)	(3933)	(3934)	(3935)
	(3936)	(3937)	(3938)	(3939)	(3940)	(3941)	(3942)
	(3943)	(3944)	(3945)	(3946)	(3947)	(3948)	(3949)
	(3950)	(3951)	(3952)	(3953)	(3954)	(3955)	(3956)
	(3957)	(3958)	(3959)	(3960)	(3961)	(3962)	(3963)
	(3964)	(3965)	(3966)	(3967)	(3968)	(3969)	(3970)
	(3971)	(3972)	(3973)	(3974)	(3975)	(3976)	(3977)
	(3978)	(3979)	(3980)	(3981)	(3982)	(3983)	(3984)
	(3985)	(3986)	(3987)	(3988)	(3989)	(3990)	(3991)
	(3992)	(3993)	(3994)	(3995)	(3996)	(3997)	(3998)
	(3999)	(4000)	(4001)	(4002)	(4003)	(4004)	(4005)
	(4006)	(4007)	(4008)	(4009)	(4010)	(4011)	(4012)
	(4013)	(4014)	(4015)	(4016)	(4017)	(4018)	(4019)
	(4020)	(4021)	(4022)	(4023)	(4024)	(4025)	(4026)
	(4027)	(4028)	(4029)	(4030)	(4031)	(4032)	(4033)
	(4034)	(4035)	(4036)	(4037)	(4038)	(4039)	(4040)
	(4041)	(4042)	(4043)	(4044)	(4045)	(4046)	(4047)
	(4048)	(4049)	(4050)	(4051)	(4052)	(4053)	(4054)
	(4055)	(4056)	(4057)	(4058)	(4059)	(4060)	(4061)
	(4062)	(4063)	(4064)	(4065)	(4066)	(4067)	(4068)
	(4069)	(4070)	(4071)	(4072)	(4073)	(4074)	(4075)
	(4076)	(4077)	(4078)	(4079)	(4080)	(4081)	(4082)
	(4083)	(4084)	(4085)	(4086)	(4087)	(4088)	(4089)
	(4090)	(4091)	(4092)	(4093)	(4094)	(4095)	(4096)
	(4097)	(4098)	(4099)	(4100)	(4101)	(4102)	(4103)
	(4104)	(4105)	(4106)	(4107)	(4108)	(4109)	(4110)
	(4111)	(4112)	(4113)	(4114)	(4115)	(4116)	(4117)
	(4118)	(4119)	(4120)	(4121)	(4122)	(4123)	(4124)
	(4125)	(4126)	(4127)	(4128)	(4129)	(4130)	(4131)
	(4132)	(4133)	(4134)	(4135)	(4136)	(4137)	(4138)
	(4139)	(4140)	(4141)	(4142)	(4143)	(4144)	(4145)
	(4146)	(4147)	(4148)	(4149)	(4150)	(4151)	(4152)
	(4153)	(4154)	(4155)	(4156)	(4157)	(4158)	(4159)
	(4160)	(4161)	(4162)	(4163)	(4164)	(4165)	(4166)
	(4167)	(4168)	(4169)	(4170)	(4171)	(4172)	(4173)
	(4174)	(4175)	(4176)	(4177)	(4178)	(4179)	(4180)
	(4181)	(4182)	(4183)	(4184)	(4185)	(4186)	(4187)
	(4188)	(4189)	(4190)	(4191)	(4192)	(4193)	(4194)
	(4195)	(4196)	(4197)	(4198)	(4199)	(4200)	(4201)
	(4202)	(4203)	(4204)	(4205)	(4206)	(4207)	(4208)
	(4209)	(4210)	(4211)	(4212)	(4213)	(4214)	(4215)
	(4216)	(4217)	(4218)	(4219)	(4220)	(4221)	(4222)
	(4223)	(4224)	(4225)	(4226)	(4227)	(4228)	(4229)
	(4230)	(4231)	(4232)	(4233)	(4234)	(4235)	(4236)
	(4237)	(4238)	(4239)	(4240)	(4241)	(4242)	(4243)
	(4244)	(4245)	(4246)	(4247)	(4248)	(4249)	(4250)

㉠ (400)	㉡ (401)	㉢ (402)	㉣ (403)	㉤ (404)	㉥ (405)	㉦ (406)	㉧ (407)
㉨ (408)	㉩ (409)	㉪ (410)	㉫ (411)	㉬ (412)	㉭ (413)	㉮ (414)	㉯ (415)
㉰ (416)	㉱ (417)	㉲ (418)	㉳ (419)	㉴ (420)	㉵ (421)	㉶ (422)	㉷ (423)
㉸ (424)	㉹ (425)	㉺ (426)	㉻ (427)	㉼ (428)	㉽ (429)	㉾ (430)	㉿ (431)
㊀ (432)	㊁ (433)	㊂ (434)	㊃ (435)	㊄ (436)	㊅ (437)	㊆ (438)	㊇ (439)
㊈ (440)	㊉ (441)	㊊ (442)	㊋ (443)	㊌ (444)	㊍ (445)	㊎ (446)	㊏ (447)
㊑ (448)	㊒ (449)	㊓ (450)	㊔ (451)	㊕ (452)	㊖ (453)	㊗ (454)	㊘ (455)
㊙ (456)	㊚ (457)	㊛ (458)	㊜ (459)	㊝ (460)	㊞ (461)	㊟ (462)	㊠ (463)
㊡ (464)	㊢ (465)	㊣ (466)	㊤ (467)	㊥ (468)	㊦ (469)	㊧ (470)	㊨ (471)
㊩ (472)	㊪ (473)	㊫ (474)	㊬ (475)	㊭ (476)	㊮ (477)	㊯ (478)	㊰ (479)
㊱ (480)	㊲ (481)	㊳ (482)	㊴ (483)	㊵ (484)	㊶ (485)	㊷ (486)	㊸ (487)
㊹ (488)	㊺ (489)	㊻ (490)	㊼ (491)	㊽ (492)	㊾ (493)	㊿ (494)	(495)











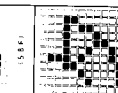
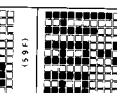
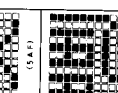
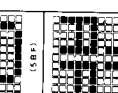
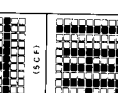
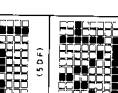

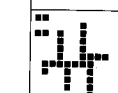
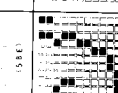
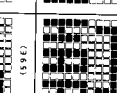
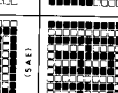
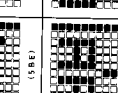



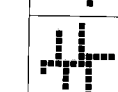
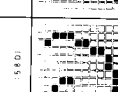
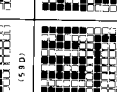

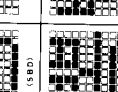





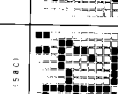
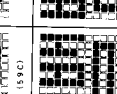

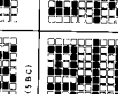
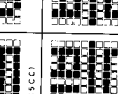

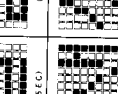

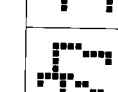
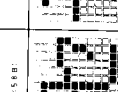

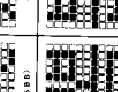





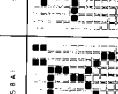



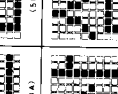
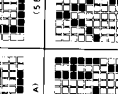

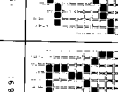
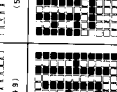
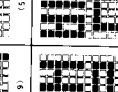
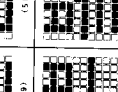





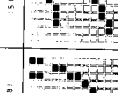
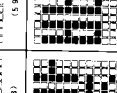





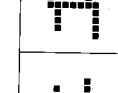
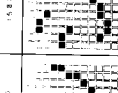
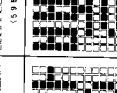

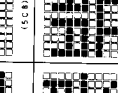



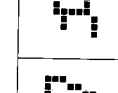
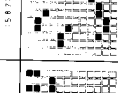

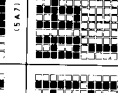



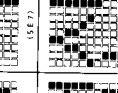

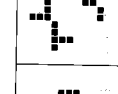

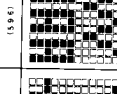

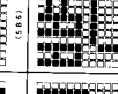

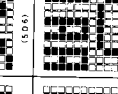
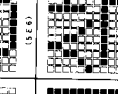

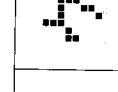
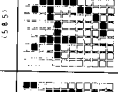
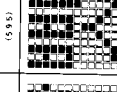
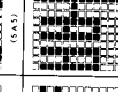
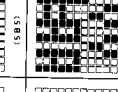
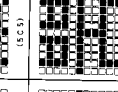
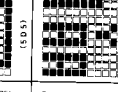



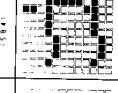

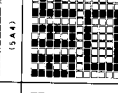
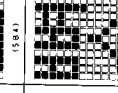
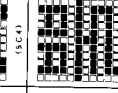





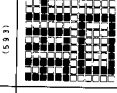
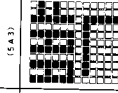
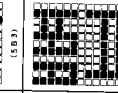
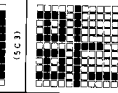
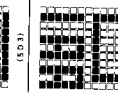
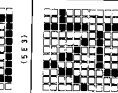

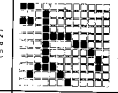
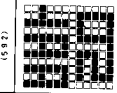
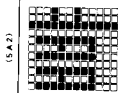
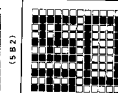
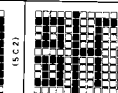
HD66730/731 A01 Korean font set (KS C 5601-1992 subset)

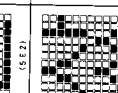
0	0	0	0	0	0	0	0
1	1	1	1	1	1	1	1
2	2	2	2	2	2	2	2
3	3	3	3	3	3	3	3
4	4	4	4	4	4	4	4
5	5	5	5	5	5	5	5
6	6	6	6	6	6	6	6
7	7	7	7	7	7	7	7
8	8	8	8	8	8	8	8
9	9	9	9	9	9	9	9
A	A	A	A	A	A	A	A
B	B	B	B	B	B	B	B
C	C	C	C	C	C	C	C
D	D	D	D	D	D	D	D
E	E	E	E	E	E	E	E
F	F	F	F	F	F	F	F
G	G	G	G	G	G	G	G
H	H	H	H	H	H	H	H
I	I	I	I	I	I	I	I
J	J	J	J	J	J	J	J
K	K	K	K	K	K	K	K
L	L	L	L	L	L	L	L
M	M	M	M	M	M	M	M
N	N	N	N	N	N	N	N
O	O	O	O	O	O	O	O
P	P	P	P	P	P	P	P
Q	Q	Q	Q	Q	Q	Q	Q
R	R	R	R	R	R	R	R
S	S	S	S	S	S	S	S
T	T	T	T	T	T	T	T
U	U	U	U	U	U	U	U
V	V	V	V	V	V	V	V
W	W	W	W	W	W	W	W
X	X	X	X	X	X	X	X
Y	Y	Y	Y	Y	Y	Y	Y
Z	Z	Z	Z	Z	Z	Z	Z
[[[[[[[[
\	\	\	\	\	\	\	\
]]]]]]]]
^	^	^	^	^	^	^	^
_	_	_	_	_	_	_	_
`	`	`	`	`	`	`	`
{	{	{	{	{	{	{	{
}	}	}	}	}	}	}	}
~	~	~	~	~	~	~	~
À	À	À	À	À	À	À	À
Á	Á	Á	Á	Á	Á	Á	Á
Â	Â	Â	Â	Â	Â	Â	Â
Ã	Ã	Ã	Ã	Ã	Ã	Ã	Ã
Ä	Ä	Ä	Ä	Ä	Ä	Ä	Ä
Å	Å	Å	Å	Å	Å	Å	Å
Æ	Æ	Æ	Æ	Æ	Æ	Æ	Æ
Ç	Ç	Ç	Ç	Ç	Ç	Ç	Ç
È	È	È	È	È	È	È	È
É	É	É	É	É	É	É	É
Ê	Ê	Ê	Ê	Ê	Ê	Ê	Ê
Ë	Ë	Ë	Ë	Ë	Ë	Ë	Ë
Ì	Ì	Ì	Ì	Ì	Ì	Ì	Ì
Í	Í	Í	Í	Í	Í	Í	Í
Î	Î	Î	Î	Î	Î	Î	Î
Ï	Ï	Ï	Ï	Ï	Ï	Ï	Ï
Ð	Ð	Ð	Ð	Ð	Ð	Ð	Ð
Ñ	Ñ	Ñ	Ñ	Ñ	Ñ	Ñ	Ñ
Ò	Ò	Ò	Ò	Ò	Ò	Ò	Ò
Ó	Ó	Ó	Ó	Ó	Ó	Ó	Ó
Ô	Ô	Ô	Ô	Ô	Ô	Ô	Ô
Õ	Õ	Õ	Õ	Õ	Õ	Õ	Õ
Ö	Ö	Ö	Ö	Ö	Ö	Ö	Ö
×	×	×	×	×	×	×	×
Ø	Ø	Ø	Ø	Ø	Ø	Ø	Ø
Ù	Ù	Ù	Ù	Ù	Ù	Ù	Ù
Ú	Ú	Ú	Ú	Ú	Ú	Ú	Ú
Û	Û	Û	Û	Û	Û	Û	Û
Ü	Ü	Ü	Ü	Ü	Ü	Ü	Ü
Ý	Ý	Ý	Ý	Ý	Ý	Ý	Ý
Þ	Þ	Þ	Þ	Þ	Þ	Þ	Þ
ß	ß	ß	ß	ß	ß	ß	ß
à	à	à	à	à	à	à	à
á	á	á	á	á	á	á	á
â	â	â	â	â	â	â	â
ã	ã	ã	ã	ã	ã	ã	ã
ä	ä	ä	ä	ä	ä	ä	ä
å	å	å	å	å	å	å	å
æ	æ	æ	æ	æ	æ	æ	æ
ç	ç	ç	ç	ç	ç	ç	ç
è	è	è	è	è	è	è	è
é	é	é	é	é	é	é	é
ê	ê	ê	ê	ê	ê	ê	ê
ë	ë	ë	ë	ë	ë	ë	ë
ì	ì	ì	ì	ì	ì	ì	ì
í	í	í	í	í	í	í	í
î	î	î	î	î	î	î	î
ï	ï	ï	ï	ï	ï	ï	ï
ð	ð	ð	ð	ð	ð	ð	ð
ñ	ñ	ñ	ñ	ñ	ñ	ñ	ñ
ò	ò	ò	ò	ò	ò	ò	ò
ó	ó	ó	ó	ó	ó	ó	ó
ô	ô	ô	ô	ô	ô	ô	ô
õ	õ	õ	õ	õ	õ	õ	õ
ö	ö	ö	ö	ö	ö	ö	ö
÷	÷	÷	÷	÷	÷	÷	÷
ø	ø	ø	ø	ø	ø	ø	ø
ù	ù	ù	ù	ù	ù	ù	ù
ú	ú	ú	ú	ú	ú	ú	ú
û	û	û	û	û	û	û	û
ü	ü	ü	ü	ü	ü	ü	ü
ý	ý	ý	ý	ý	ý	ý	ý
þ	þ	þ	þ	þ	þ	þ	þ
ÿ	ÿ	ÿ	ÿ	ÿ	ÿ	ÿ	ÿ

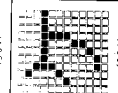
HD66730/HD66731

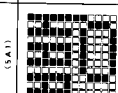
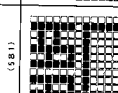
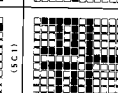
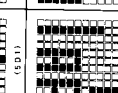
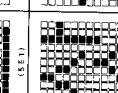
HD66730/731 A01 Korean font set (KS C 5601-1992 subset)

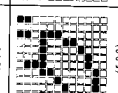
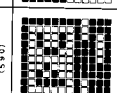
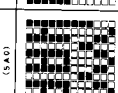
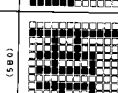
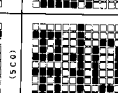
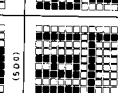
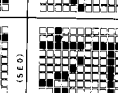
HD66730/731 A01 Korean font set (KS C 5601-1992 subset)

工 (6097)	의 (6197)	하 (6297)	하 (6397)	하 (6497)	하 (6597)	하 (6697)	하 (6797)
의 (6098)	의 (6198)	하 (6298)	하 (6398)	하 (6498)	하 (6598)	하 (6698)	하 (6798)
의 (6099)	의 (6199)	하 (6299)	하 (6399)	하 (6499)	하 (6599)	하 (6699)	하 (6799)
의 (6100)	의 (6200)	하 (6300)	하 (6400)	하 (6500)	하 (6600)	하 (6700)	하 (6800)
의 (6101)	의 (6201)	하 (6301)	하 (6401)	하 (6501)	하 (6601)	하 (6701)	하 (6801)
의 (6102)	의 (6202)	하 (6302)	하 (6402)	하 (6502)	하 (6602)	하 (6702)	하 (6802)
의 (6103)	의 (6203)	하 (6303)	하 (6403)	하 (6503)	하 (6603)	하 (6703)	하 (6803)
의 (6104)	의 (6204)	하 (6304)	하 (6404)	하 (6504)	하 (6604)	하 (6704)	하 (6804)
의 (6105)	의 (6205)	하 (6305)	하 (6405)	하 (6505)	하 (6605)	하 (6705)	하 (6805)
의 (6106)	의 (6206)	하 (6306)	하 (6406)	하 (6506)	하 (6606)	하 (6706)	하 (6806)
의 (6107)	의 (6207)	하 (6307)	하 (6407)	하 (6507)	하 (6607)	하 (6707)	하 (6807)
의 (6108)	의 (6208)	하 (6308)	하 (6408)	하 (6508)	하 (6608)	하 (6708)	하 (6808)
의 (6109)	의 (6209)	하 (6309)	하 (6409)	하 (6509)	하 (6609)	하 (6709)	하 (6809)
의 (6110)	의 (6210)	하 (6310)	하 (6410)	하 (6510)	하 (6610)	하 (6710)	하 (6810)
의 (6111)	의 (6211)	하 (6311)	하 (6411)	하 (6511)	하 (6611)	하 (6711)	하 (6811)
의 (6112)	의 (6212)	하 (6312)	하 (6412)	하 (6512)	하 (6612)	하 (6712)	하 (6812)
의 (6113)	의 (6213)	하 (6313)	하 (6413)	하 (6513)	하 (6613)	하 (6713)	하 (6813)
의 (6114)	의 (6214)	하 (6314)	하 (6414)	하 (6514)	하 (6614)	하 (6714)	하 (6814)
의 (6115)	의 (6215)	하 (6315)	하 (6415)	하 (6515)	하 (6615)	하 (6715)	하 (6815)
의 (6116)	의 (6216)	하 (6316)	하 (6416)	하 (6516)	하 (6616)	하 (6716)	하 (6816)
의 (6117)	의 (6217)	하 (6317)	하 (6417)	하 (6517)	하 (6617)	하 (6717)	하 (6817)
의 (6118)	의 (6218)	하 (6318)	하 (6418)	하 (6518)	하 (6618)	하 (6718)	하 (6818)
의 (6119)	의 (6219)	하 (6319)	하 (6419)	하 (6519)	하 (6619)	하 (6719)	하 (6819)
의 (6120)	의 (6220)	하 (6320)	하 (6420)	하 (6520)	하 (6620)	하 (6720)	하 (6820)

HD66730/731 A01 Korean font set (KS C 5601-1992 subset)

0x10000	0x10001	0x10002	0x10003	0x10004	0x10005	0x10006	0x10007
0x10008	0x10009	0x1000A	0x1000B	0x1000C	0x1000D	0x1000E	0x1000F
0x10010	0x10011	0x10012	0x10013	0x10014	0x10015	0x10016	0x10017
0x10018	0x10019	0x1001A	0x1001B	0x1001C	0x1001D	0x1001E	0x1001F
0x10020	0x10021	0x10022	0x10023	0x10024	0x10025	0x10026	0x10027
0x10028	0x10029	0x1002A	0x1002B	0x1002C	0x1002D	0x1002E	0x1002F
0x10030	0x10031	0x10032	0x10033	0x10034	0x10035	0x10036	0x10037
0x10038	0x10039	0x1003A	0x1003B	0x1003C	0x1003D	0x1003E	0x1003F
0x10040	0x10041	0x10042	0x10043	0x10044	0x10045	0x10046	0x10047
0x10048	0x10049	0x1004A	0x1004B	0x1004C	0x1004D	0x1004E	0x1004F
0x10050	0x10051	0x10052	0x10053	0x10054	0x10055	0x10056	0x10057
0x10058	0x10059	0x1005A	0x1005B	0x1005C	0x1005D	0x1005E	0x1005F
0x10060	0x10061	0x10062	0x10063	0x10064	0x10065	0x10066	0x10067
0x10068	0x10069	0x1006A	0x1006B	0x1006C	0x1006D	0x1006E	0x1006F
0x10070	0x10071	0x10072	0x10073	0x10074	0x10075	0x10076	0x10077
0x10078	0x10079	0x1007A	0x1007B	0x1007C	0x1007D	0x1007E	0x1007F
0x10080	0x10081	0x10082	0x10083	0x10084	0x10085	0x10086	0x10087
0x10088	0x10089	0x1008A	0x1008B	0x1008C	0x1008D	0x1008E	0x1008F
0x10090	0x10091	0x10092	0x10093	0x10094	0x10095	0x10096	0x10097
0x10098	0x10099	0x1009A	0x1009B	0x1009C	0x1009D	0x1009E	0x1009F
0x100A0	0x100A1	0x100A2	0x100A3	0x100A4	0x100A5	0x100A6	0x100A7
0x100A8	0x100A9	0x100AA	0x100AB	0x100AC	0x100AD	0x100AE	0x100AF
0x100B0	0x100B1	0x100B2	0x100B3	0x100B4	0x100B5	0x100B6	0x100B7
0x100B8	0x100B9	0x100BA	0x100BB	0x100BC	0x100BD	0x100BE	0x100BF
0x100C0	0x100C1	0x100C2	0x100C3	0x100C4	0x100C5	0x100C6	0x100C7
0x100C8	0x100C9	0x100CA	0x100CB	0x100CC	0x100CD	0x100CE	0x100CF
0x100D0	0x100D1	0x100D2	0x100D3	0x100D4	0x100D5	0x100D6	0x100D7
0x100D8	0x100D9	0x100DA	0x100DB	0x100DC	0x100DD	0x100DE	0x100DF
0x100E0	0x100E1	0x100E2	0x100E3	0x100E4	0x100E5	0x100E6	0x100E7
0x100E8	0x100E9	0x100EA	0x100EB	0x100EC	0x100ED	0x100EE	0x100EF
0x100F0	0x100F1	0x100F2	0x100F3	0x100F4	0x100F5	0x100F6	0x100F7
0x100F8	0x100F9	0x100FA	0x100FB	0x100FC	0x100FD	0x100FE	0x100FF

HD66730/HD66731

HD66730/731 A01 Korean font set (KS C 5601-1992 subset)

가	가	가	가	가	가	가	가
706E	711E	724E	733E	744E	755E	766E	777E
하	하	하	하	하	하	하	하
706F	711F	724F	733F	744F	755F	766F	777F
우	우	우	우	우	우	우	우
7070	7120	7250	7340	7450	7560	7670	7780
오	오	오	오	오	오	오	오
7071	7121	7251	7341	7451	7561	7671	7781
우	우	우	우	우	우	우	우
7072	7122	7252	7342	7452	7562	7672	7782
우	우	우	우	우	우	우	우
7073	7123	7253	7343	7453	7563	7673	7783
우	우	우	우	우	우	우	우
7074	7124	7254	7344	7454	7564	7674	7784
우	우	우	우	우	우	우	우
7075	7125	7255	7345	7455	7565	7675	7785
우	우	우	우	우	우	우	우
7076	7126	7256	7346	7456	7566	7676	7786
우	우	우	우	우	우	우	우
7077	7127	7257	7347	7457	7567	7677	7787
우	우	우	우	우	우	우	우
7078	7128	7258	7348	7458	7568	7678	7788
우	우	우	우	우	우	우	우
7079	7129	7259	7349	7459	7569	7679	7789
우	우	우	우	우	우	우	우
7080	7130	7260	7350	7460	7570	7680	7790
우	우	우	우	우	우	우	우
7081	7131	7261	7351	7461	7571	7681	7791
우	우	우	우	우	우	우	우
7082	7132	7262	7352	7462	7572	7682	7792
우	우	우	우	우	우	우	우
7083	7133	7263	7353	7463	7573	7683	7793
우	우	우	우	우	우	우	우
7084	7134	7264	7354	7464	7574	7684	7794
우	우	우	우	우	우	우	우
7085	7135	7265	7355	7465	7575	7685	7795
우	우	우	우	우	우	우	우
7086	7136	7266	7356	7466	7576	7686	7796
우	우	우	우	우	우	우	우
7087	7137	7267	7357	7467	7577	7687	7797
우	우	우	우	우	우	우	우
7088	7138	7268	7358	7468	7578	7688	7798
우	우	우	우	우	우	우	우
7089	7139	7269	7359	7469	7579	7689	7799
우	우	우	우	우	우	우	우
7090	7140	7270	7360	7470	7580	7690	7700
우	우	우	우	우	우	우	우

Fullfont Code Map 030 ~ 137

HD66730/731 A01 Korean font set (KS C 5601-1992 subset)

ㄱ	ㄴ	ㄷ	ㄹ	ㅁ	ㅂ	ㅃ	ㅄ
ㅅ	ㅇ	ㅈ	ㅊ	ㅋ	ㆁ	ㆂ	ㆃ
ㆄ	ㆅ	ㆆ	ㆇ	ㆈ	ㆉ	ㆊ	ㆋ
ㆌ	ㆍ	ㆎ	㆏	㆐	㆑	㆒	㆓
㆔	㆕	㆖	㆗	㆘	㆙	㆚	㆛
㆜	㆝	㆞	㆟	ㆠ	ㆡ	ㆢ	ㆣ
ㆤ	ㆥ	ㆦ	ㆧ	ㆨ	ㆩ	ㆪ	ㆫ
ㆬ	ㆭ	ㆮ	ㆯ	ㆰ	ㆱ	ㆲ	ㆳ
ㆴ	ㆵ	ㆶ	ㆷ	ㆸ	ㆹ	ㆺ	ㆻ
ㆼ	ㆽ	ㆾ	ㆿ	ㆿ	ㆿ	ㆿ	ㆿ
ㅀ	ㅁ	ㅂ	ㅃ	ㅄ	ㅅ	ㅆ	ㅈ
ㅉ	ㅊ	ㅋ	ㆁ	ㆂ	ㆃ	ㆄ	ㆅ
ㆆ	ㆇ	ㆈ	ㆉ	ㆊ	ㆋ	ㆌ	ㆍ
ㆎ	㆏	㆐	㆑	㆒	㆓	㆔	㆕
㆖	㆗	㆘	㆙	㆚	㆛	㆜	㆝
㆞	㆟	ㆠ	ㆡ	ㆢ	ㆣ	ㆤ	ㆥ
ㆦ	ㆧ	ㆨ	ㆩ	ㆪ	ㆫ	ㆬ	ㆭ
ㆮ	ㆯ	ㆰ	ㆱ	ㆲ	ㆳ	ㆴ	ㆵ
ㆶ	ㆷ	ㆸ	ㆹ	ㆺ	ㆻ	ㆼ	ㆽ
ㆿ	ㆿ	ㆿ	ㆿ	ㆿ	ㆿ	ㆿ	ㆿ
ㅁ	ㅂ	ㅃ	ㅄ	ㅅ	ㅆ	ㅈ	ㅉ
ㅊ	ㅋ	ㆁ	ㆂ	ㆃ	ㆄ	ㆅ	ㆆ
ㆇ	ㆈ	ㆉ	ㆊ	ㆋ	ㆌ	ㆍ	ㆎ
㆏	㆐	㆑	㆒	㆓	㆔	㆕	㆖
㆗	㆘	㆙	㆚	㆛	㆜	㆝	㆞
㆟	ㆠ	ㆡ	ㆢ	ㆣ	ㆤ	ㆥ	ㆦ
ㆧ	ㆨ	ㆩ	ㆪ	ㆫ	ㆬ	ㆭ	ㆮ
ㆯ	ㆰ	ㆱ	ㆲ	ㆳ	ㆴ	ㆵ	ㆶ
ㆷ	ㆸ	ㆹ	ㆺ	ㆻ	ㆼ	ㆽ	ㆿ
ㆿ	ㆿ	ㆿ	ㆿ	ㆿ	ㆿ	ㆿ	ㆿ

HD66730/HD66731

HD66730/731 A01 Korean font set (KS C 5601-1992 subset)

0000	0001	0002	0003	0004	0005	0006	0007
0008	0009	0010	0011	0012	0013	0014	0015
0016	0017	0018	0019	0020	0021	0022	0023
0024	0025	0026	0027	0028	0029	0030	0031
0032	0033	0034	0035	0036	0037	0038	0039
0040	0041	0042	0043	0044	0045	0046	0047
0048	0049	0050	0051	0052	0053	0054	0055
0056	0057	0058	0059	0060	0061	0062	0063
0064	0065	0066	0067	0068	0069	0070	0071
0072	0073	0074	0075	0076	0077	0078	0079
0080	0081	0082	0083	0084	0085	0086	0087
0088	0089	0090	0091	0092	0093	0094	0095
0096	0097	0098	0099	0100	0101	0102	0103
0104	0105	0106	0107	0108	0109	0110	0111
0112	0113	0114	0115	0116	0117	0118	0119
0120	0121	0122	0123	0124	0125	0126	0127
0128	0129	0130	0131	0132	0133	0134	0135
0136	0137	0138	0139	0140	0141	0142	0143
0144	0145	0146	0147	0148	0149	0150	0151
0152	0153	0154	0155	0156	0157	0158	0159
0160	0161	0162	0163	0164	0165	0166	0167
0168	0169	0170	0171	0172	0173	0174	0175
0176	0177	0178	0179	0180	0181	0182	0183
0184	0185	0186	0187	0188	0189	0190	0191
0192	0193	0194	0195	0196	0197	0198	0199

HD66730/731 A01 Korean font set (KS C 5601-1992 subset)

0	1	2	3	4	5	6	7	8
9	A	B	C	D	E	F	G	H
I	J	K	L	M	N	O	P	Q
R	S	T	U	V	W	X	Y	Z
[\]	^	_	`	a	b	c
d	e	f	g	h	i	j	k	l
m	n	o	p	q	r	s	t	u
v	w	x	y	z	{		}	~
0	1	2	3	4	5	6	7	8
9	A	B	C	D	E	F	G	H
I	J	K	L	M	N	O	P	Q
R	S	T	U	V	W	X	Y	Z
[\]	^	_	`	a	b	c
d	e	f	g	h	i	j	k	l
m	n	o	p	q	r	s	t	u
v	w	x	y	z	{		}	~
0	1	2	3	4	5	6	7	8
9	A	B	C	D	E	F	G	H
I	J	K	L	M	N	O	P	Q
R	S	T	U	V	W	X	Y	Z
[\]	^	_	`	a	b	c
d	e	f	g	h	i	j	k	l
m	n	o	p	q	r	s	t	u
v	w	x	y	z	{		}	~
0	1	2	3	4	5	6	7	8
9	A	B	C	D	E	F	G	H
I	J	K	L	M	N	O	P	Q
R	S	T	U	V	W	X	Y	Z
[\]	^	_	`	a	b	c
d	e	f	g	h	i	j	k	l
m	n	o	p	q	r	s	t	u
v	w	x	y	z	{		}	~
0	1	2	3	4	5	6	7	8
9	A	B	C	D	E	F	G	H
I	J	K	L	M	N	O	P	Q
R	S	T	U	V	W	X	Y	Z
[\]	^	_	`	a	b	c
d	e	f	g	h	i	j	k	l
m	n	o	p	q	r	s	t	u
v	w	x	y	z	{		}	~

Font: HD66730/731 A01 Korean font set (KS C 5601-1992 subset)

HD66730/HD66731

HD66730/731 A01 Korean font set (KS C 5601-1992 subset)

가 (900F)	나 (901F)	다 (902F)	라 (903F)	사 (904F)	자 (905F)	차 (906F)	카 (907F)
국 (9081)	궁 (9091)	구 (90A1)	구 (90B1)	구 (90C1)	구 (90D1)	구 (90E1)	구 (90F1)
국 (9101)	궁 (9111)	구 (9121)	구 (9131)	구 (9141)	구 (9151)	구 (9161)	구 (9171)
국 (9181)	궁 (9191)	구 (91A1)	구 (91B1)	구 (91C1)	구 (91D1)	구 (91E1)	구 (91F1)
국 (9201)	궁 (9211)	구 (9221)	구 (9231)	구 (9241)	구 (9251)	구 (9261)	구 (9271)
국 (9281)	궁 (9291)	구 (92A1)	구 (92B1)	구 (92C1)	구 (92D1)	구 (92E1)	구 (92F1)
국 (9301)	궁 (9311)	구 (9321)	구 (9331)	구 (9341)	구 (9351)	구 (9361)	구 (9371)
국 (9381)	궁 (9391)	구 (93A1)	구 (93B1)	구 (93C1)	구 (93D1)	구 (93E1)	구 (93F1)
국 (9401)	궁 (9411)	구 (9421)	구 (9431)	구 (9441)	구 (9451)	구 (9461)	구 (9471)
국 (9481)	궁 (9491)	구 (94A1)	구 (94B1)	구 (94C1)	구 (94D1)	구 (94E1)	구 (94F1)
국 (9501)	궁 (9511)	구 (9521)	구 (9531)	구 (9541)	구 (9551)	구 (9561)	구 (9571)
국 (9581)	궁 (9591)	구 (95A1)	구 (95B1)	구 (95C1)	구 (95D1)	구 (95E1)	구 (95F1)
국 (9601)	궁 (9611)	구 (9621)	구 (9631)	구 (9641)	구 (9651)	구 (9661)	구 (9671)
국 (9681)	궁 (9691)	구 (96A1)	구 (96B1)	구 (96C1)	구 (96D1)	구 (96E1)	구 (96F1)
국 (9701)	궁 (9711)	구 (9721)	구 (9731)	구 (9741)	구 (9751)	구 (9761)	구 (9771)
국 (9781)	궁 (9791)	구 (97A1)	구 (97B1)	구 (97C1)	구 (97D1)	구 (97E1)	구 (97F1)
국 (9801)	궁 (9811)	구 (9821)	구 (9831)	구 (9841)	구 (9851)	구 (9861)	구 (9871)
국 (9881)	궁 (9891)	구 (98A1)	구 (98B1)	구 (98C1)	구 (98D1)	구 (98E1)	구 (98F1)
국 (9901)	궁 (9911)	구 (9921)	구 (9931)	구 (9941)	구 (9951)	구 (9961)	구 (9971)
국 (9981)	궁 (9991)	구 (99A1)	구 (99B1)	구 (99C1)	구 (99D1)	구 (99E1)	구 (99F1)

Font-Path: Code-Misc-200-312

HD66730/731 A01 Korean font set (KS C 5601-1992 subset)

ㄴ (987F)	ㄴ (988F)	ㄴ (989F)	ㄴ (98AF)	ㄴ (98BF)	ㄴ (98CF)	ㄴ (98DF)	ㄴ (98EF)
ㄴ (98FF)	ㄴ (990E)	ㄴ (991E)	ㄴ (992E)	ㄴ (993E)	ㄴ (994E)	ㄴ (995E)	ㄴ (996E)
ㄴ (997E)	ㄴ (998E)	ㄴ (999E)	ㄴ (99AE)	ㄴ (99BE)	ㄴ (99CE)	ㄴ (99DE)	ㄴ (99EE)
ㄴ (99FC)	ㄴ (99GC)	ㄴ (99AC)	ㄴ (99BC)	ㄴ (99CC)	ㄴ (99DC)	ㄴ (99EC)	ㄴ (99FC)
ㄴ (990D)	ㄴ (991D)	ㄴ (992D)	ㄴ (993D)	ㄴ (994D)	ㄴ (995D)	ㄴ (996D)	ㄴ (997D)
ㄴ (998D)	ㄴ (999D)	ㄴ (99AD)	ㄴ (99BD)	ㄴ (99CD)	ㄴ (99DD)	ㄴ (99ED)	ㄴ (99FD)
ㄴ (99A4)	ㄴ (99B4)	ㄴ (99C4)	ㄴ (99D4)	ㄴ (99E4)	ㄴ (99F4)	ㄴ (9905)	ㄴ (9915)
ㄴ (9925)	ㄴ (9935)	ㄴ (9945)	ㄴ (9955)	ㄴ (9965)	ㄴ (9975)	ㄴ (9985)	ㄴ (9995)
ㄴ (99A5)	ㄴ (99B5)	ㄴ (99C5)	ㄴ (99D5)	ㄴ (99E5)	ㄴ (99F5)	ㄴ (9906)	ㄴ (9916)
ㄴ (9926)	ㄴ (9936)	ㄴ (9946)	ㄴ (9956)	ㄴ (9966)	ㄴ (9976)	ㄴ (9986)	ㄴ (9996)
ㄴ (99A6)	ㄴ (99B6)	ㄴ (99C6)	ㄴ (99D6)	ㄴ (99E6)	ㄴ (99F6)	ㄴ (9907)	ㄴ (9917)
ㄴ (9927)	ㄴ (9937)	ㄴ (9947)	ㄴ (9957)	ㄴ (9967)	ㄴ (9977)	ㄴ (9987)	ㄴ (9997)
ㄴ (99A7)	ㄴ (99B7)	ㄴ (99C7)	ㄴ (99D7)	ㄴ (99E7)	ㄴ (99F7)	ㄴ (9908)	ㄴ (9918)
ㄴ (9928)	ㄴ (9938)	ㄴ (9948)	ㄴ (9958)	ㄴ (9968)	ㄴ (9978)	ㄴ (9988)	ㄴ (9998)
ㄴ (99A8)	ㄴ (99B8)	ㄴ (99C8)	ㄴ (99D8)	ㄴ (99E8)	ㄴ (99F8)	ㄴ (9909)	ㄴ (9919)
ㄴ (9929)	ㄴ (9939)	ㄴ (9949)	ㄴ (9959)	ㄴ (9969)	ㄴ (9979)	ㄴ (9989)	ㄴ (9999)
ㄴ (99A9)	ㄴ (99B9)	ㄴ (99C9)	ㄴ (99D9)	ㄴ (99E9)	ㄴ (99F9)	ㄴ (990A)	ㄴ (991A)
ㄴ (992A)	ㄴ (993A)	ㄴ (994A)	ㄴ (995A)	ㄴ (996A)	ㄴ (997A)	ㄴ (998A)	ㄴ (999A)
ㄴ (99A0)	ㄴ (99B0)	ㄴ (99C0)	ㄴ (99D0)	ㄴ (99E0)	ㄴ (99F0)	ㄴ (9901)	ㄴ (9911)
ㄴ (9921)	ㄴ (9931)	ㄴ (9941)	ㄴ (9951)	ㄴ (9961)	ㄴ (9971)	ㄴ (9981)	ㄴ (9991)
ㄴ (99A1)	ㄴ (99B1)	ㄴ (99C1)	ㄴ (99D1)	ㄴ (99E1)	ㄴ (99F1)	ㄴ (9902)	ㄴ (9912)
ㄴ (9922)	ㄴ (9932)	ㄴ (9942)	ㄴ (9952)	ㄴ (9962)	ㄴ (9972)	ㄴ (9982)	ㄴ (9992)
ㄴ (99A2)	ㄴ (99B2)	ㄴ (99C2)	ㄴ (99D2)	ㄴ (99E2)	ㄴ (99F2)	ㄴ (9903)	ㄴ (9913)
ㄴ (9923)	ㄴ (9933)	ㄴ (9943)	ㄴ (9953)	ㄴ (9963)	ㄴ (9973)	ㄴ (9983)	ㄴ (9993)
ㄴ (99A3)	ㄴ (99B3)	ㄴ (99C3)	ㄴ (99D3)	ㄴ (99E3)	ㄴ (99F3)	ㄴ (9904)	ㄴ (9914)
ㄴ (9924)	ㄴ (9934)	ㄴ (9944)	ㄴ (9954)	ㄴ (9964)	ㄴ (9974)	ㄴ (9984)	ㄴ (9994)
ㄴ (99A4)	ㄴ (99B4)	ㄴ (99C4)	ㄴ (99D4)	ㄴ (99E4)	ㄴ (99F4)	ㄴ (9905)	ㄴ (9915)
ㄴ (9925)	ㄴ (9935)	ㄴ (9945)	ㄴ (9955)	ㄴ (9965)	ㄴ (9975)	ㄴ (9985)	ㄴ (9995)
ㄴ (99A5)	ㄴ (99B5)	ㄴ (99C5)	ㄴ (99D5)	ㄴ (99E5)	ㄴ (99F5)	ㄴ (9906)	ㄴ (9916)
ㄴ (9926)	ㄴ (9936)	ㄴ (9946)	ㄴ (9956)	ㄴ (9966)	ㄴ (9976)	ㄴ (9986)	ㄴ (9996)
ㄴ (99A6)	ㄴ (99B6)	ㄴ (99C6)	ㄴ (99D6)	ㄴ (99E6)	ㄴ (99F6)	ㄴ (9907)	ㄴ (9917)
ㄴ (9927)	ㄴ (9937)	ㄴ (9947)	ㄴ (9957)	ㄴ (9967)	ㄴ (9977)	ㄴ (9987)	ㄴ (9997)
ㄴ (99A7)	ㄴ (99B7)	ㄴ (99C7)	ㄴ (99D7)	ㄴ (99E7)	ㄴ (99F7)	ㄴ (9908)	ㄴ (9918)
ㄴ (9928)	ㄴ (9938)	ㄴ (9948)	ㄴ (9958)	ㄴ (9968)	ㄴ (9978)	ㄴ (9988)	ㄴ (9998)
ㄴ (99A8)	ㄴ (99B8)	ㄴ (99C8)	ㄴ (99D8)	ㄴ (99E8)	ㄴ (99F8)	ㄴ (9909)	ㄴ (9919)
ㄴ (9929)	ㄴ (9939)	ㄴ (9949)	ㄴ (9959)	ㄴ (9969)	ㄴ (9979)	ㄴ (9989)	ㄴ (9999)
ㄴ (99A9)	ㄴ (99B9)	ㄴ (99C9)	ㄴ (99D9)	ㄴ (99E9)	ㄴ (99F9)	ㄴ (990A)	ㄴ (991A)
ㄴ (992A)	ㄴ (993A)	ㄴ (994A)	ㄴ (995A)	ㄴ (996A)	ㄴ (997A)	ㄴ (998A)	ㄴ (999A)











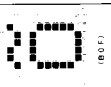
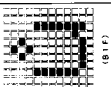
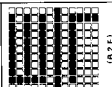

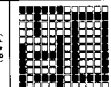

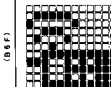
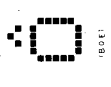
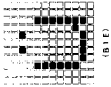
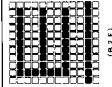
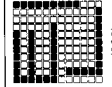



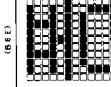

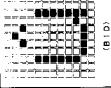



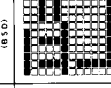

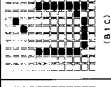
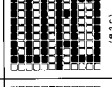

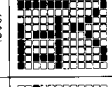
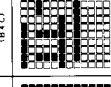
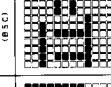

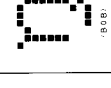
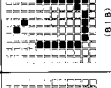
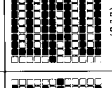

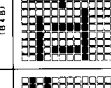
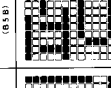

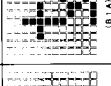
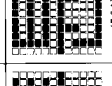

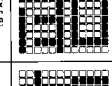
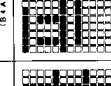

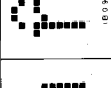
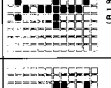
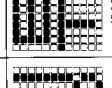
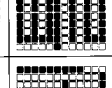

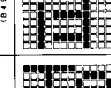

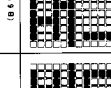

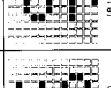
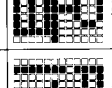
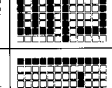
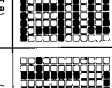

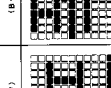

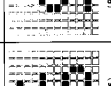
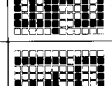
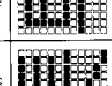
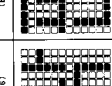

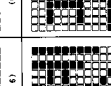
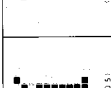
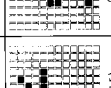

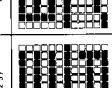





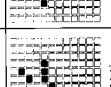
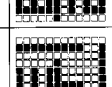
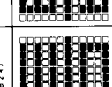



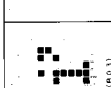
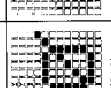

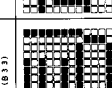

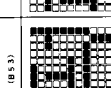
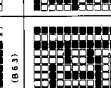
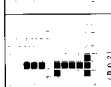
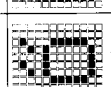
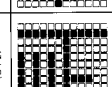

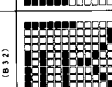
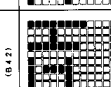
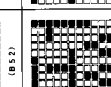
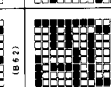
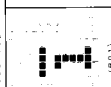
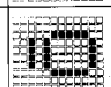

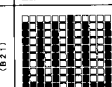

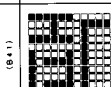
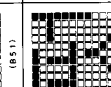

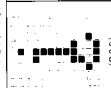
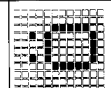
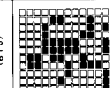
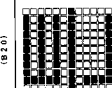
HD66730/HD66731

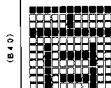
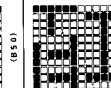
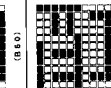
HD66730/731 A01 Korean font set (KS C 5601-1992 subset)

Full Font Code Msk AUG - A7E

HD66730/HD66731

HD66730/731 A01 Korean font set (KS C 5601–1992 subset)

							
(B0F)	(B1F)	(B2F)	(B3F)	(B4F)	(B5F)	(B6F)	(B7F)
							
(B0E)	(B1E)	(B2E)	(B3E)	(B4E)	(B5E)	(B6E)	(B7E)
							
(B0D)	(B1D)	(B2D)	(B3D)	(B4D)	(B5D)	(B6D)	(B7D)
							
(B0C)	(B1C)	(B2C)	(B3C)	(B4C)	(B5C)	(B6C)	(B7C)
							
(B0B)	(B1B)	(B2B)	(B3B)	(B4B)	(B5B)	(B6B)	(B7B)
							
(B0A)	(B1A)	(B2A)	(B3A)	(B4A)	(B5A)	(B6A)	(B7A)
							
(B09)	(B19)	(B29)	(B39)	(B49)	(B59)	(B69)	(B79)
							
(B08)	(B18)	(B28)	(B38)	(B48)	(B58)	(B68)	(B78)
							
(B07)	(B17)	(B27)	(B37)	(B47)	(B57)	(B67)	(B77)
							
(B06)	(B16)	(B26)	(B36)	(B46)	(B56)	(B66)	(B76)
							
(B05)	(B15)	(B25)	(B35)	(B45)	(B55)	(B65)	(B75)
							
(B04)	(B14)	(B24)	(B34)	(B44)	(B54)	(B64)	(B74)
							
(B03)	(B13)	(B23)	(B33)	(B43)	(B53)	(B63)	(B73)
							
(B02)	(B12)	(B22)	(B32)	(B42)	(B52)	(B62)	(B72)
							
(B01)	(B11)	(B21)	(B31)	(B41)	(B51)	(B61)	(B71)
							
(B00)	(B10)	(B20)	(B30)	(B40)	(B50)	(B60)	(B70)

Fullfont Corp. Mac, PC, EBCDIC, BDF

HD66730/731 A01 Korean font set (KS C 5601-1992 subset)

가	가	가	가	가	가	가	가
 (B8F7)	 (B8F7)	 (B8F7)	 (B8F7)	 (B8F7)	 (B8F7)	 (B8F7)	 (B8F7)
 (B8E7)	 (B8E7)	 (B8E7)	 (B8E7)	 (B8E7)	 (B8E7)	 (B8E7)	 (B8E7)
 (B8D0)	 (B8D0)	 (B8D0)	 (B8D0)	 (B8D0)	 (B8D0)	 (B8D0)	 (B8D0)
 (B8C7)	 (B8C7)	 (B8C7)	 (B8C7)	 (B8C7)	 (B8C7)	 (B8C7)	 (B8C7)
 (B8B0)	 (B8B0)	 (B8B0)	 (B8B0)	 (B8B0)	 (B8B0)	 (B8B0)	 (B8B0)
 (B8A4)	 (B8A4)	 (B8A4)	 (B8A4)	 (B8A4)	 (B8A4)	 (B8A4)	 (B8A4)
 (B894)	 (B894)	 (B894)	 (B894)	 (B894)	 (B894)	 (B894)	 (B894)
 (B884)	 (B884)	 (B884)	 (B884)	 (B884)	 (B884)	 (B884)	 (B884)
 (B877)	 (B877)	 (B877)	 (B877)	 (B877)	 (B877)	 (B877)	 (B877)
 (B86C)	 (B86C)	 (B86C)	 (B86C)	 (B86C)	 (B86C)	 (B86C)	 (B86C)
 (B855)	 (B855)	 (B855)	 (B855)	 (B855)	 (B855)	 (B855)	 (B855)
 (B844)	 (B844)	 (B844)	 (B844)	 (B844)	 (B844)	 (B844)	 (B844)
 (B833)	 (B833)	 (B833)	 (B833)	 (B833)	 (B833)	 (B833)	 (B833)
 (B822)	 (B822)	 (B822)	 (B822)	 (B822)	 (B822)	 (B822)	 (B822)
 (B811)	 (B811)	 (B811)	 (B811)	 (B811)	 (B811)	 (B811)	 (B811)
 (B800)	 (B800)	 (B800)	 (B800)	 (B800)	 (B800)	 (B800)	 (B800)

HD66730/HD66731

HD66730/731 A01 Korean font set (KS C 5601-1992 subset)

								(C 674)
								(C 675)
								(C 676)
								(C 677)
								(C 678)
								(C 679)
								(C 680)
								(C 681)
								(C 682)
								(C 683)
								(C 684)
								(C 685)
								(C 686)
								(C 687)
								(C 688)
								(C 689)
								(C 690)
								(C 691)
								(C 692)
								(C 693)
								(C 694)
								(C 695)
								(C 696)
								(C 697)
								(C 698)
								(C 699)
								(C 700)

HD66730/731 A01 Korean font set (KS C 5601-1992 subset)











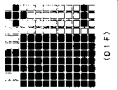
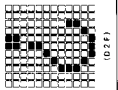

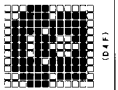
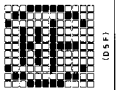
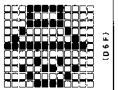
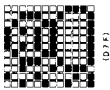
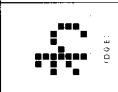
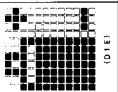
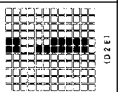
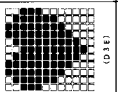

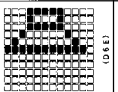
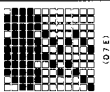
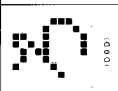

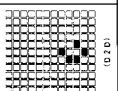
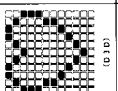

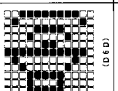
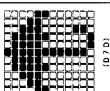
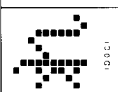
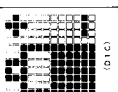
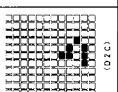
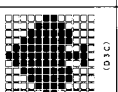
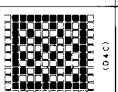
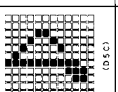
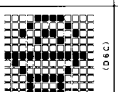
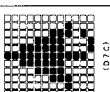
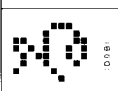

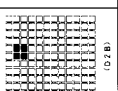
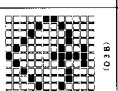
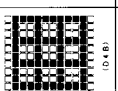

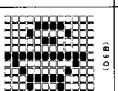
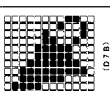
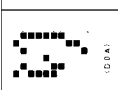
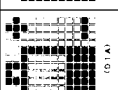
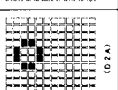
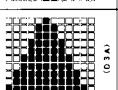
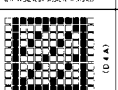
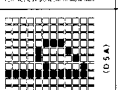
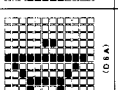

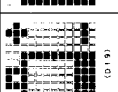
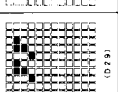
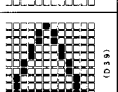





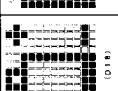
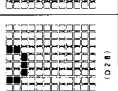
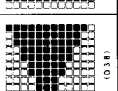

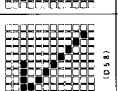

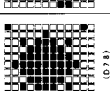

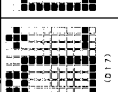

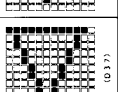



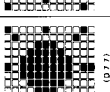

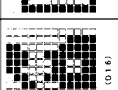
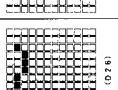

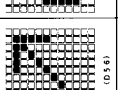

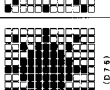
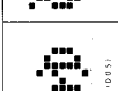

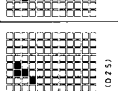

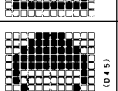
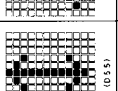
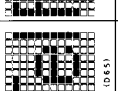
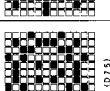

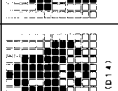
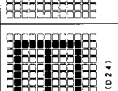
(CBF)	(CBF)	(CAF)	(CBF)	(CCF)	(CDF)	(CEFF)	(CFF)
(CBE)	(CBE)	(CAE)	(CBE)	(CEE)	(CDE)	(CEE)	(CFE)
(CBD)	(CBD)	(CAD)	(CBD)	(CED)	(CDD)	(CED)	(CFD)
(CBE)	(CBE)	(CAE)	(CBE)	(CEE)	(CDE)	(CEE)	(CFE)
(CBB)	(CBB)	(CAB)	(CBB)	(CEB)	(CDB)	(CEB)	(CFB)
(CBA)	(CBA)	(CAA)	(CBA)	(CEA)	(CDA)	(CEA)	(CFA)
(CB9)	(CB9)	(CA9)	(CB9)	(CE9)	(CD9)	(CE9)	(CF9)
(CB8)	(CB8)	(CA8)	(CB8)	(CE8)	(CD8)	(CE8)	(CF8)
(CB7)	(CB7)	(CA7)	(CB7)	(CE7)	(CD7)	(CE7)	(CF7)
(CB6)	(CB6)	(CA6)	(CB6)	(CE6)	(CD6)	(CE6)	(CF6)
(CB5)	(CB5)	(CA5)	(CB5)	(CE5)	(CD5)	(CE5)	(CF5)
(CB4)	(CB4)	(CA4)	(CB4)	(CE4)	(CD4)	(CE4)	(CF4)
(CB3)	(CB3)	(CA3)	(CB3)	(CE3)	(CD3)	(CE3)	(CF3)
(CB2)	(CB2)	(CA2)	(CB2)	(CE2)	(CD2)	(CE2)	(CF2)
(CB1)	(CB1)	(CA1)	(CB1)	(CE1)	(CD1)	(CE1)	(CF1)
(CB0)	(CB0)	(CA0)	(CB0)	(CE0)	(CD0)	(CE0)	(CF0)

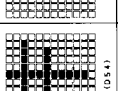
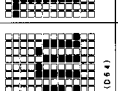
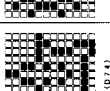
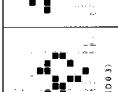
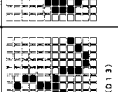
FontFont Code MZE CS0 - CFF

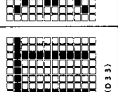
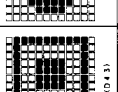
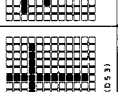
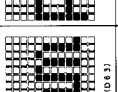
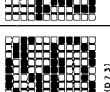
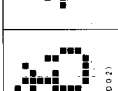
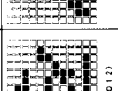
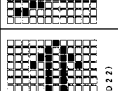
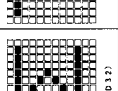

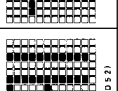

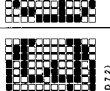
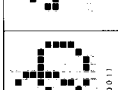
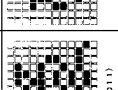
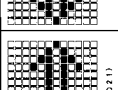
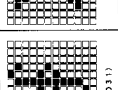
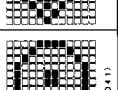
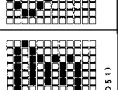

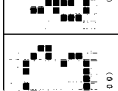
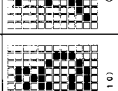
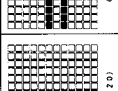
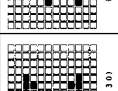
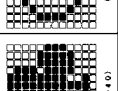
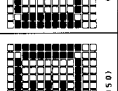
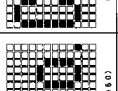
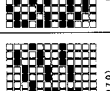



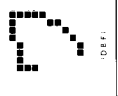
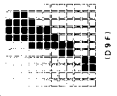
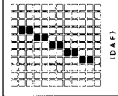
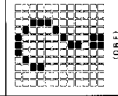
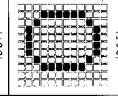
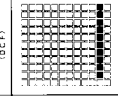
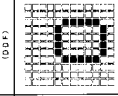
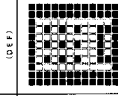
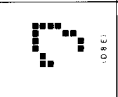
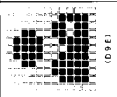
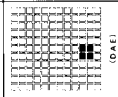
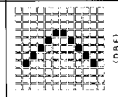
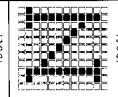
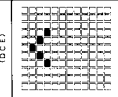
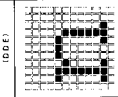
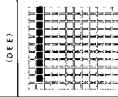
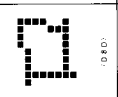
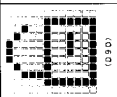
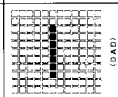
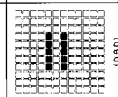
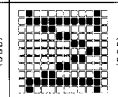
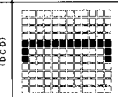
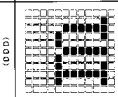
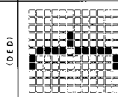
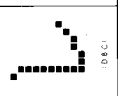
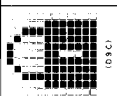
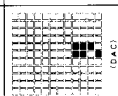
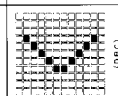
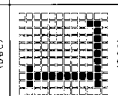
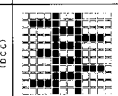
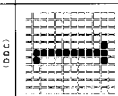
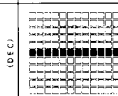
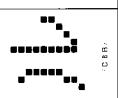
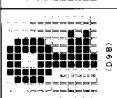
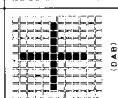
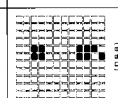
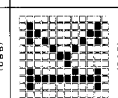
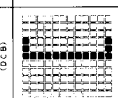
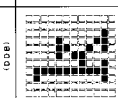
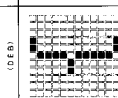
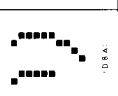
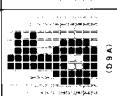

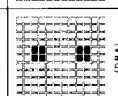
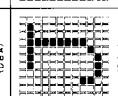
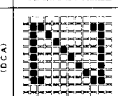
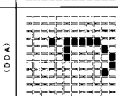
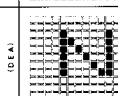
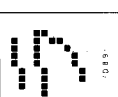

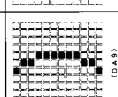
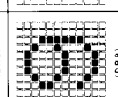
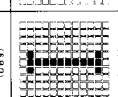
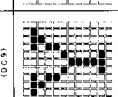
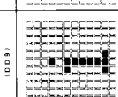
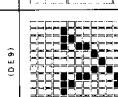

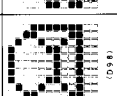
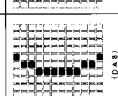
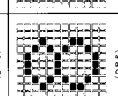
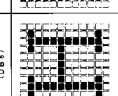

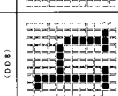
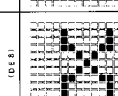
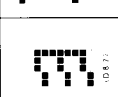
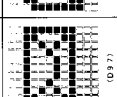
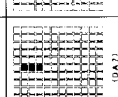
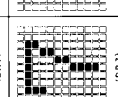

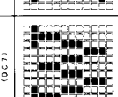
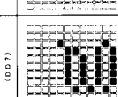
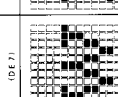

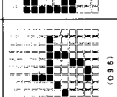
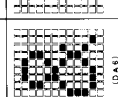
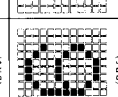
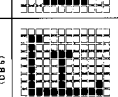
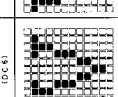

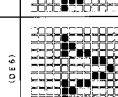
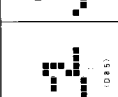
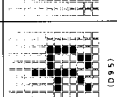
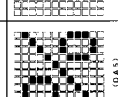
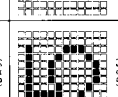



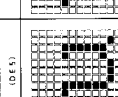

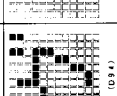
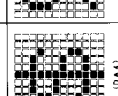
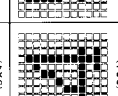
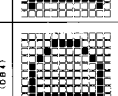
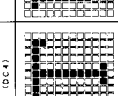
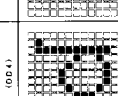
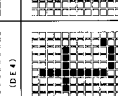
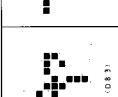
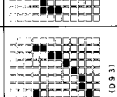
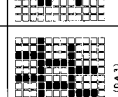
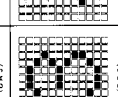
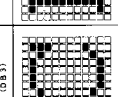
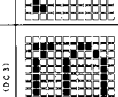
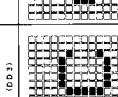
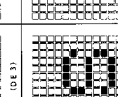
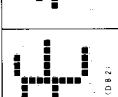
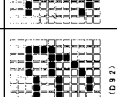
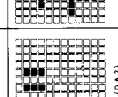
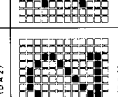
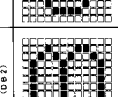
HD66730/HD66731

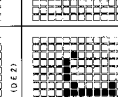
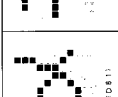
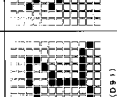
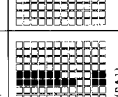
HD66730/731 A01 Korean font set (KS C 5601-1992 subset)

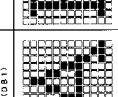
Full-Font Code-Mask 000 - 07F

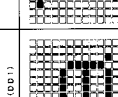
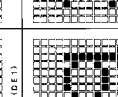
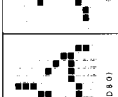
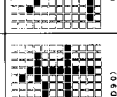
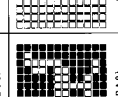
 (0000)	 (0001)	 (0002)	 (0003)	 (0004)	 (0005)	 (0006)	 (0007)
 (0008)	 (0009)	 (000A)	 (000B)	 (000C)	 (000D)	 (000E)	 (000F)
 (0010)	 (0011)	 (0012)	 (0013)	 (0014)	 (0015)	 (0016)	 (0017)
 (0018)	 (0019)	 (001A)	 (001B)	 (001C)	 (001D)	 (001E)	 (001F)
 (0020)	 (0021)	 (0022)	 (0023)	 (0024)	 (0025)	 (0026)	 (0027)
 (0028)	 (0029)	 (002A)	 (002B)	 (002C)	 (002D)	 (002E)	 (002F)
 (0030)	 (0031)	 (0032)	 (0033)	 (0034)	 (0035)	 (0036)	 (0037)
 (0038)	 (0039)	 (003A)	 (003B)	 (003C)	 (003D)	 (003E)	 (003F)
 (0040)	 (0041)	 (0042)	 (0043)	 (0044)	 (0045)	 (0046)	 (0047)
 (0048)	 (0049)	 (004A)	 (004B)	 (004C)	 (004D)	 (004E)	 (004F)
 (0050)	 (0051)	 (0052)	 (0053)	 (0054)	 (0055)	 (0056)	 (0057)
 (0058)	 (0059)	 (005A)	 (005B)	 (005C)	 (005D)	 (005E)	 (005F)
 (0060)	 (0061)	 (0062)	 (0063)	 (0064)	 (0065)	 (0066)	 (0067)
 (0068)	 (0069)	 (006A)	 (006B)	 (006C)	 (006D)	 (006E)	 (006F)
 (0070)	 (0071)	 (0072)	 (0073)	 (0074)	 (0075)	 (0076)	 (0077)
 (0078)	 (0079)	 (007A)	 (007B)	 (007C)	 (007D)	 (007E)	 (007F)

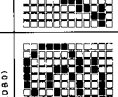
HD66730/731 A01 Korean font set (KS C 5601-1992 subset)

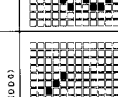
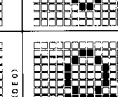
 (0800)	 (0801)	 (0802)	 (0803)	 (0804)	 (0805)	 (0806)	 (0807)
 (0808)	 (0809)	 (0810)	 (0811)	 (0812)	 (0813)	 (0814)	 (0815)
 (0816)	 (0817)	 (0818)	 (0819)	 (0820)	 (0821)	 (0822)	 (0823)
 (0824)	 (0825)	 (0826)	 (0827)	 (0828)	 (0829)	 (0830)	 (0831)
 (0832)	 (0833)	 (0834)	 (0835)	 (0836)	 (0837)	 (0838)	 (0839)
 (0840)	 (0841)	 (0842)	 (0843)	 (0844)	 (0845)	 (0846)	 (0847)
 (0848)	 (0849)	 (0850)	 (0851)	 (0852)	 (0853)	 (0854)	 (0855)
 (0856)	 (0857)	 (0858)	 (0859)	 (0860)	 (0861)	 (0862)	 (0863)
 (0864)	 (0865)	 (0866)	 (0867)	 (0868)	 (0869)	 (0870)	 (0871)
 (0872)	 (0873)	 (0874)	 (0875)	 (0876)	 (0877)	 (0878)	 (0879)
 (0880)	 (0881)	 (0882)	 (0883)	 (0884)	 (0885)	 (0886)	 (0887)
 (0888)	 (0889)	 (0890)	 (0891)	 (0892)	 (0893)	 (0894)	 (0895)
 (0896)	 (0897)	 (0898)	 (0899)	 (0900)	 (0901)	 (0902)	 (0903)
 (0904)	 (0905)	 (0906)	 (0907)	 (0908)	 (0909)	 (0910)	 (0911)
 (0912)	 (0913)	 (0914)	 (0915)	 (0916)	 (0917)	 (0918)	 (0919)
 (0920)	 (0921)	 (0922)	 (0923)	 (0924)	 (0925)	 (0926)	 (0927)

Full-font Code Map 080 - 0FF

HD66730/HD66731

HD66730/731 A01 Korean font set (KS C 5601-1992 subset)

0	1	2	3	4	5	6	7	8
9	0	1	2	3	4	5	6	7
8	9	0	1	2	3	4	5	6
7	8	9	0	1	2	3	4	5
6	7	8	9	0	1	2	3	4
5	6	7	8	9	0	1	2	3
4	5	6	7	8	9	0	1	2
3	4	5	6	7	8	9	0	1
2	3	4	5	6	7	8	9	0
1	2	3	4	5	6	7	8	9
0	1	2	3	4	5	6	7	8
9	0	1	2	3	4	5	6	7
8	9	0	1	2	3	4	5	6
7	8	9	0	1	2	3	4	5
6	7	8	9	0	1	2	3	4
5	6	7	8	9	0	1	2	3
4	5	6	7	8	9	0	1	2
3	4	5	6	7	8	9	0	1
2	3	4	5	6	7	8	9	0
1	2	3	4	5	6	7	8	9
0	1	2	3	4	5	6	7	8

Font-Font Code Map E00 - E7F

HD66730/731 A01 Korean font set (KS C 5601-1992 subset)

田 (E8D0)	器 (E8D1)	长 (E8D2)	和 (E8D3)	〇 (E8D4)	■ (E8D5)	○ (E8D6)	◎ (E8D7)
米 (E8E0)	烟 (E8E1)	烟 (E8E2)	烟 (E8E3)	川 (E8E4)	烟 (E8E5)	烟 (E8E6)	烟 (E8E7)
烟 (E8F0)	烟 (E8F1)	烟 (E8F2)	烟 (E8F3)	烟 (E8F4)	烟 (E8F5)	烟 (E8F6)	烟 (E8F7)
烟 (E900)	烟 (E901)	烟 (E902)	烟 (E903)	烟 (E904)	烟 (E905)	烟 (E906)	烟 (E907)
烟 (E910)	烟 (E911)	烟 (E912)	烟 (E913)	烟 (E914)	烟 (E915)	烟 (E916)	烟 (E917)
烟 (E920)	烟 (E921)	烟 (E922)	烟 (E923)	烟 (E924)	烟 (E925)	烟 (E926)	烟 (E927)
烟 (E930)	烟 (E931)	烟 (E932)	烟 (E933)	烟 (E934)	烟 (E935)	烟 (E936)	烟 (E937)
烟 (E940)	烟 (E941)	烟 (E942)	烟 (E943)	烟 (E944)	烟 (E945)	烟 (E946)	烟 (E947)
烟 (E950)	烟 (E951)	烟 (E952)	烟 (E953)	烟 (E954)	烟 (E955)	烟 (E956)	烟 (E957)
烟 (E960)	烟 (E961)	烟 (E962)	烟 (E963)	烟 (E964)	烟 (E965)	烟 (E966)	烟 (E967)
烟 (E970)	烟 (E971)	烟 (E972)	烟 (E973)	烟 (E974)	烟 (E975)	烟 (E976)	烟 (E977)
烟 (E980)	烟 (E981)	烟 (E982)	烟 (E983)	烟 (E984)	烟 (E985)	烟 (E986)	烟 (E987)
烟 (E990)	烟 (E991)	烟 (E992)	烟 (E993)	烟 (E994)	烟 (E995)	烟 (E996)	烟 (E997)
烟 (E9A0)	烟 (E9A1)	烟 (E9A2)	烟 (E9A3)	烟 (E9A4)	烟 (E9A5)	烟 (E9A6)	烟 (E9A7)
烟 (E9B0)	烟 (E9B1)	烟 (E9B2)	烟 (E9B3)	烟 (E9B4)	烟 (E9B5)	烟 (E9B6)	烟 (E9B7)
烟 (E9C0)	烟 (E9C1)	烟 (E9C2)	烟 (E9C3)	烟 (E9C4)	烟 (E9C5)	烟 (E9C6)	烟 (E9C7)
烟 (E9D0)	烟 (E9D1)	烟 (E9D2)	烟 (E9D3)	烟 (E9D4)	烟 (E9D5)	烟 (E9D6)	烟 (E9D7)
烟 (E9E0)	烟 (E9E1)	烟 (E9E2)	烟 (E9E3)	烟 (E9E4)	烟 (E9E5)	烟 (E9E6)	烟 (E9E7)
烟 (E9F0)	烟 (E9F1)	烟 (E9F2)	烟 (E9F3)	烟 (E9F4)	烟 (E9F5)	烟 (E9F6)	烟 (E9F7)

Font Code Map EOD - F7E

HD66730/731 A01 Korean font set (KS C 5601-1992 subset)

Cutil-Font_C5601_M48-18D...FFF

Relationship between Character Codes (DDRAM), CGRAM Addresses, and Display Characters

Full size character codes H'000 to H'007 can be used to access 8 character patterns in the CGRAM. Since each character pattern can be displayed up to 12 × 13 dots, CGRAM patterns can be displayed immediately next to each other (to the right, left, top, or bottom) without any character spaces between them. Table 6 shows the correspondence between CGRAM addresses and full-size character codes for access of the CGRAM by the MPU.

Table 7 Relationship between Character Codes (DDRAM), CGRAM Addresses, and Display Characters

Character Code					CGRAM Data																								
					CGRAM Address					A0 = 0						A0 = 1													
C11	C10	C9	C8	C7	A7	A6	A5	A4	A3	A2	A1	D7	D6	D5	D4	D3	D2	D1	D0	D7	D6	D5	D4	D3	D2	D1	D0		
0	0	0	0	0	0	0	0	0	0	0	0	A	A	0	0	0	0	0	0	A	A	0	0	0	0	0	0	Character pattern (1)	
												A	A	0	1	1	1	1	1	A	A	1	1	1	1	1	0		
												A	A	0	1	0	0	0	0	A	A	0	0	0	1	0	0		
												A	A	0	1	0	0	0	0	A	A	0	0	0	1	0	0		
												A	A	0	1	0	0	0	0	A	A	0	0	0	1	0	0		
												A	A	0	1	0	0	0	0	A	A	0	0	0	1	0	0		
												A	A	0	1	1	1	1	1	A	A	1	1	1	1	1	0		
												A	A	0	1	1	1	1	1	A	A	1	1	1	1	1	0		
												A	A	0	1	0	0	0	0	A	A	0	0	0	1	0	0		
												A	A	0	1	0	0	0	0	A	A	0	0	0	1	0	0		
												A	A	0	1	0	0	0	0	A	A	0	0	0	1	0	0		
												A	A	0	1	0	0	0	0	A	A	0	0	0	1	0	0		
												A	A	0	1	1	1	1	1	A	A	1	1	1	1	1	0		
0	0	0	0	0	0	0	0	0	0	0	0	A	A	0	0	0	0	0	1	A	A	0	0	0	0	0	0	Character pattern (2)	
												A	A	0	1	1	1	1	1	A	A	1	1	1	1	1	0		
												A	A	0	0	0	1	1	1	A	A	0	0	0	1	0	0		
												A	A	0	0	1	0	0	0	A	A	0	0	0	1	0	0		
												A	A	0	0	1	0	0	0	A	A	0	0	0	1	0	0		
												A	A	0	0	1	0	0	0	A	A	0	0	0	1	0	0		
												A	A	0	0	1	0	0	0	A	A	0	0	0	1	0	0		
												A	A	0	0	1	0	0	0	A	A	0	0	0	1	0	0		
												A	A	0	0	0	1	0	0	A	A	0	0	0	1	0	0		
												A	A	0	0	0	1	0	0	A	A	0	0	0	1	0	0		
												A	A	0	0	0	1	0	0	A	A	0	0	0	1	0	0		
												A	A	0	0	0	0	1	0	0	A	A	0	0	0	1	0		0
												A	A	1	1	1	1	1	1	A	A	1	1	1	1	1	0		
												A	A	0	0	0	0	0	0	A	A	0	0	0	0	0	0		
												A	A	0	0	0	0	0	0	A	A	0	0	0	0	0	0		
0	0	0	0	0	1	1	1	1	1	1	1	A	A	0	0	1	0	0	0	A	A	0	0	1	0	0	0	Character pattern (8)	
												A	A	0	1	0	0	0	1	A	A	0	0	1	0	0	0		
												A	A	0	1	0	0	0	1	A	A	0	0	0	1	0	0		
												A	A	1	0	0	0	0	1	A	A	0	0	0	0	1	0		
												A	A	1	0	0	0	0	1	A	A	0	0	0	0	1	0		
												A	A	1	0	0	0	0	1	A	A	0	0	0	0	1	0		
												A	A	1	0	0	0	0	1	A	A	0	0	0	0	1	0		
												A	A	1	0	0	0	0	1	A	A	0	0	0	0	1	0		
												A	A	1	0	0	0	0	1	A	A	0	0	0	0	1	0		
												A	A	0	1	0	0	0	1	A	A	0	0	0	1	0	0		
												A	A	0	1	0	0	0	1	A	A	0	0	0	1	0	0		
												A	A	0	1	0	0	0	1	A	A	0	0	0	1	0	0		
												A	A	0	0	0	0	0	0	A	A	0	0	0	0	0	0		
												A	A	0	0	0	0	0	0	A	A	0	0	0	0	0	0		

- Notes:
1. CGRAM is selected when the upper 9 bits (C3 to C11) of the full size character codes are 0. In this case, the lower 3 bits (C0 to C2) of the character code correspond to bits 5 to 7 (A5 to A7) (3 bits: 8 types) in the CGRAM address.
 2. CGRAM address bits 1 to 4 (A1 to A4) designate the character pattern line position. The 12th line is the cursor position and its display is formed by a logical OR with the cursor.
 3. CGRAM address 0 (A0) corresponds to the left-half and right-half of a full-size character pattern.
 4. The character data is stored with the rightmost character element in bit 0 (LSB), as shown in the table above. Pattern produced by bits 0 to 5 is displayed and 13 raster-rows are displayed together. Thus, an arbitrary character pattern consisting of 12×13 dots can be displayed.
 5. A set bit in the CGRAM data corresponds to display selection, and 0 to non-selection.
 6. The upper two bits (AA) of CGRAM data indicate the display attribute for the lower 6-bit pattern. In this case, display attributes specified for the DDRAM during full-size character display is disabled. When these upper two bits are 00, the CGRAM pattern is simply displayed as set; when 01, the pattern reverses (black/white), when 10, the pattern blinks; and when 11, the pattern reverses and blinks.

Relationship between SEGRAM Addresses and Display Patterns

SEGRAM data is displayed when the select level of the COMS pin is output. Since SEGRAM data does not depend on character code data in DDRAM, and does not undergo horizontal smooth scroll, it can be used to display icon and marks. The following shows the relationship between SEGRAM addresses and segment output pins.

Table 8 Relationship between SEGRAM Addresses and Display Patterns

SEGRAM Address				SEGRAM Data							
A3	A2	A1	A0	D7	D6	D5	D4	D3	D2	D1	D0
0	0	0	0	B1	B0	SEG1	SEG2	SEG3	SEG4	SEG5	SEG6
0	0	0	1	B1	B0	SEG7	SEG8	SEG9	SEG10	SEG11	SEG12
0	0	1	0	B1	B0	SEG13	SEG14	SEG15	SEG16	SEG17	SEG18
0	0	1	1	B1	B0	SEG19	SEG20	SEG21	SEG22	SEG23	SEG24
0	1	0	0	B1	B0	SEG25	SEG26	SEG27	SEG28	SEG29	SEG30
0	1	0	1	B1	B0	SEG31	SEG32	SEG33	SEG34	SEG35	SEG36
0	1	1	0	B1	B0	SEG37	SEG38	SEG39	SEG40	SEG41	SEG42
0	1	1	1	B1	B0	SEG43	SEG44	SEG45	SEG46	SEG47	SEG48
1	0	0	0	B1	B0	SEG49	SEG50	SEG51	SEG52	SEG53	SEG54
1	0	0	1	B1	B0	SEG55	SEG56	SEG57	SEG58	SEG59	SEG60
1	0	1	0	B1	B0	SEG61	SEG62	SEG63	SEG64	SEG65	SEG66
1	0	1	1	B1	B0	SEG67	SEG68	SEG69	SEG70	SEG71	SEG72
1	1	0	0	B1	B0	SEG73	SEG74	SEG75	SEG76	SEG77	SEG78
1	1	0	1	B1	B0	SEG79	SEG80	SEG81	SEG82	SEG83	SEG84
1	1	1	0	B1	B0	SEG85	SEG86	SEG87	SEG88	SEG89	SEG90
1	1	1	1	B1	B0	SEG91	SEG92	SEG93	SEG94	SEG95	SEG96

Blinking control

Pattern on/off

- Notes:
1. SEG1 to SEG71 are pin numbers of the segment output driver of the HD66730. Pin SEG1 is positioned on the left edge of the display. Segments from SEG72 on are displayed by extension drivers. After SEG 96, display is performed from SEG1 again.
 2. The lower six bits (D0 to D5) indicate display on/off for of each segment. A bit setting of 1 selects display while 0 selects no display.
 3. Pattern blinking of the lower six bits is controlled by the upper two bits (D6 and D7) of SEGRAM data. When the upper two bits (B0 and B1) are 10, segments whose corresponding bits in the lower 6 bits are set to 1 will blink on the display. When the upper two bits (B0 and B1) are 01, only the bit-5 pattern can blink. Do not attempt to set the upper two bits (B0 and B1) to 11 (setting is prohibited).

Register Functions

Outline

Data can be written from the MPU to the internal control registers and internal RAM of the HD66730/1 via an 8-bit bus interface or a serial interface. There are five types of internal control registers, as follows (details are described later):

- Index register: Selects and designates which control register the MPU is to access
- Status register: Indicates the internal state
- Control registers: Designates display control
- RAM address register: Sets an address for accessing the various RAMs
- RAM data register: Receives and transmits data to and from the various RAMs

Table 17 shows the instruction list and the number of execution cycles of each instruction after performing register setting. Instructions that perform data transfer with the RAM data register tend to be used the most. However, auto-incrementation by 1 (or auto decrementation by 1) of internal HD66730/1 RAM addresses after each data write can lighten the program load on the MPU. Note that when an instruction is being executed (internal operations are being performed), only the busy flag in the status register can be read.

Since the busy flag is 1 during execution, the MPU should check this value before accessing a register. When accessing a register without checking the busy flag, an interval longer than the instruction execution time is needed before the next access. Refer to Table 17 Instruction Registers, for instruction execution times.

When rewriting DDRAM, character display will momentarily breakdown if the data (character codes) that is being rewritten is also being read by the system for display. For this reason, check the display read line position (NF) and the display read raster-row position (LF) in the status register (SR), and rewrite a DDRAM line that is not being read and displayed.

Functional Description

Index Register (IR)

The index register (Figure 4) designates control registers (R0 to R7), RAM address register (RAR: R8), and RAM data register (RDR: R9). The register number must be set between addresses 0000 to 1001 in binary digits. Note that if address 1111 is set, the test register will be selected. Addresses 1010 to 1110 are ignored.

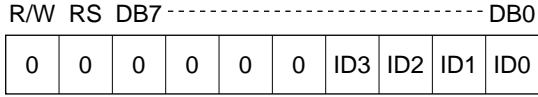

Figure 4 Index Register

Status Register (ST)

The status register (Figure 5) includes the busy flag (BF), display line bits (NF1/0), and display raster-row bits (LF0 to LF3). If BF is 1, an instruction is being executed, and another instruction will not be accepted during this time. Any attempt to write data to a register at this time is ignored.

Rasters-rows are driven one at a time according to specific timing to perform liquid crystal display. Bits NF1 and NF0 indicate display lines, and bits LF3 to LF0 indicate the raster-row in a line. If character display degenerates when rewriting DDRAM, rewrite only those display lines that are not currently being read out by the system for display. During segment display, the next state of the last raster-row in the character display is read out.

Table 9 Display State According to NF1 and NF0

NF1	NF0	Display State
0	0	Displaying the first line
0	1	Displaying the second line
1	0	Displaying the third line
1	1	Displaying the fourth line

Table 10 Display State According to LF3 to LF0

LF3	LF2	LF1	LF0	Display State
0	0	0	0	Displaying the first raster-row
0	0	0	1	Displaying the second raster-row
0	0	1	0	Displaying the third raster-row
0	0	1	1	Displaying the fourth raster-row
•				•
•				•
•				•
1	1	0	0	Displaying the 13th raster-row

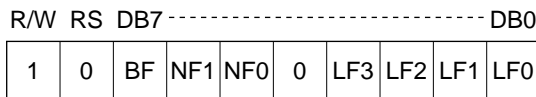

Figure 5 Status Register

Entry Mode Register (R0)

The entry mode register (Figure 6) includes bits I/D, RM1, and RM0.

I/D: Increments ($I/D = 1$) or decrements ($I/D = 0$) the DDRAM address by 1 when a character code is written into or read out from the DDRAM. When the DDRAM address is incremented by 1, the cursor or blinking will also shift to the right. This applies to both CGRAM and SEGRAM.

RM1/0: Selects DDRAM, CGRAM, or SEGRAM for access (Table 10).

Table 11 RAM Selection by RM1 and RM0

RM1	RM0	Selected RAM
0	0/1	Display data RAM (DDRAM)
1	0	Character generator RAM (CGRAM)
1	1	Segment RAM (SEGRAM)

R/W RS DB7-----DB0

0	1	0	0	0	0	0	I/D	RM1	RM0
---	---	---	---	---	---	---	-----	-----	-----

Figure 6 Entry Mode Register

Function Set Register (R1)

The function set register (Figure 7) includes bits BST, EXT2, EXT1, DT1, DT0, and DCL.

BST: When BST is 1, the booster starts to operate. When the LCD voltage is external, set BST to 0 to stop operation of the internal booster. In addition, the consumption current can be suppressed by stopping the booster when entering standby mode without display.

EXT2/1: Extends the common driver and segment driver of HD66730. Set EXT2 to 1 to extend the driver to the common side if the duty ratio is 1/40 or 1/53. Extend the driver to the segment side by setting EXT1 to 1 when displaying 7 or more digits (of full size) in the horizontal direction. DDRAM capacity is 80 bytes. When the HD66731, these EXT2/1 bits must be set to 1.

DT1/0: Selects the duty ratio of the LCD (Table 11). Although this bit can be set separately from the display line designation (NL1/0), the duty ratio must be selected so that it will be smaller than the number of display lines.

DCL: When DCL is 1, the display is cleared by writing the code for half-size space (H'A0) into all DDRAM addresses. Then H'00 is written into the RAM address counter (RAR) and the DDRAM is selected. The character code for character code H'A0 must be a blank pattern when rewriting HCGROM used for half-size characters.

Cursor Control Register (R2)

The cursor control register includes bits CHM, C, CM1, and CM0.

CHM: When CHM is set to 1, DDRAM is selected, the RAM address counter (RAR) is set to 0, and the cursor home instruction is executed. The contents of DDRAM do not change. The cursor or blinking moves to the left edge of the display (the left edge of the first line if two lines are displayed).

C: When C = 1, cursor display is turned on. The cursor is displayed at the position corresponding to the count value of the RAM address counter (RAR). To set data in the RAR, set the index register (IDR) to 1000 to select it, and modify the data in the RAR. Note that the RAM address counter (RAR) automatically increments (decrements) when the RAM is accessed, and the cursor will move accordingly.

CM1/0: Selects cursor display mode (Table 12 and Figure 9). The blinking frequency (cycle) of the blink cursor and the white/black inverted cursor has 64 frames.

Table 12 Duty Drive Ratio

DT1	DT0	Duty Drive Ratio
0	0	1/14 duty drive
0	1	1/27 duty drive
1	0	1/40 duty drive
1	1	1/53 duty drive

Table 13 Cursor Mode Selection

CM1	CM0	Selected Cursor Mode
0	0	12th raster-row cursor
0	1	Blink cursor
1	0/1	White/black inverted cursor

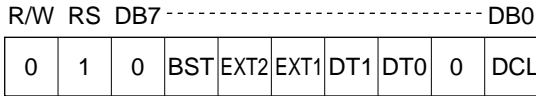

Figure 7 Function Set Register

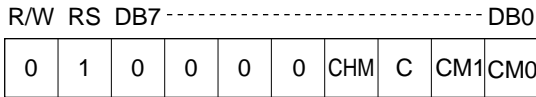
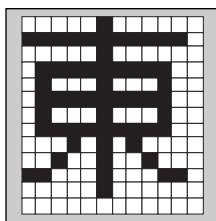
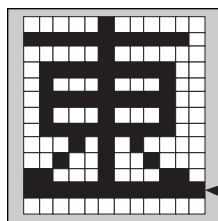

Figure 8 Cursor Control Register



Normal display example



i) 12th-raster-row display example

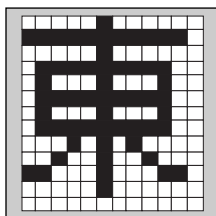

↔
Alternating
display



ii) Blink display example

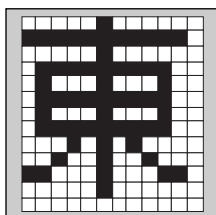

↔
Alternating
display

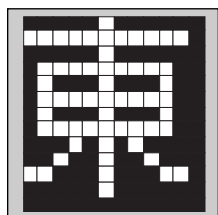

iii) White/black inverted display example

Figure 9 Cursor Display Examples

Display Control Register 1 (R3)

The display control register 1 (Figure 10) includes bits ST, DC, and DS.

ST: When ST is 1, the display control register 1 enters the standby mode. The internal operation clock is divided into 32. Data cannot be displayed on the LCD panel, however, the consumption current can be suppressed during the standby mode. Note that the register setting value and the data inside the RAM are maintained.

DC: When DC is 1, the character display is turned on.

DS: When DS is 1, the segment display is turned on. Bit DS can selectively display marks.

Display Control Register 2 (R4)

NC1/0: Selects the display character in the horizontal direction. When performing a horizontal smooth scroll, set the number of display characters larger than the actual number of liquid crystal drive characters. When the frame frequency (cycle) is stable, the operation frequency is proportional to the display characters. Operation frequency must be suppressed by setting the number of display character as small as possible because the consumption current is proportional to the operation frequency. Refer to Oscillator for details.

NL1/0: Sets the number of display lines. Set the number of display lines larger than the duty drive ratio (DT1/0). Do not set 10 to these bits. Table 13 indicates the settings of the display lines.

Table 14 Display Control Register 2 Setting

Display Lines NL1/0	Display Characters: NC1/0		
	00	01	10
00	1-line 6 characters	1-line 20 characters	1-line 40 characters
01	2-line 6 characters	2-line 10 characters	2-line 20 characters
10	Setting is inhibited.		
11	4-line 6 characters	4-line 10 characters	4-line 10 characters

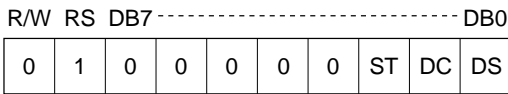

Figure 10 Display Control Register 1

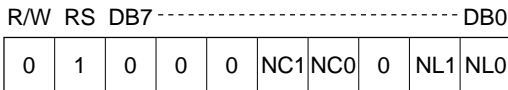

Figure 11 Display Control Register 2

Scroll Control Register 1 (R5)

The scroll control register 1 (Figure 12) includes bits SN1, SN0, SL3, SL2, SL1, and SL0.

SN1/0: Selects the starting line to be displayed. When SN1/0 shows 00, display begins from the first line. When SN1/0 shows 01, 10, 11, display begins from the second, third, or fourth line, respectively. Use these bits within the display line setting (NL1/0). SN can be used to display a smooth scroll and DDRAM memory bank switching.

SL0 to SL3: Selects the scroll starting raster-row of the line set by the start display line (SL1/0). When these bits show 0000, a display line starting from the head raster-row (first raster-row) is displayed and can be set to 1100 (13th raster-row) showing the last raster-row. A vertical smooth scroll can be performed by sequentially incrementing the first raster-row. Refer to Vertical Smooth Scroll for details. Note that bits SL0 to SL3 that are set to a value above 1100 will not operate correctly.

Scroll Control Register 2 (R6)

The scroll control register 2 (Figure 13) includes bits PS1, PS0, SE4, SE3, SE2, and SE1.

PS1/0: Selects the partial smooth scroll mode. When PS1/0 bits are 00, all characters scroll horizontally across the display. When bits PS1/0 are 01, only the leftmost character is fixed and the remaining characters perform horizontal smooth scroll display. When bits PS1/0 are 10, the two leftmost bits, and when 11, the three leftmost characters are fixed and the remaining characters perform horizontal smooth scroll. Refer to Partial Smooth Scroll for details.

SE1 to SE4: These bits enable a dot scroll in display lines designated by scroll control register 3 (R7). When bit SE is 1, the first line is scrolled according to scroll control register 3 (R7). When SE2 is 1, the second line scrolls independently, when SE3 is 1, the third line scrolls independently, when SE4 is 1, the fourth line scrolls independently. Scrolling multiple lines at the same time is also possible.

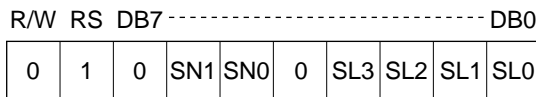

Figure 12 Scroll Control Register 1

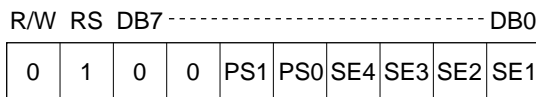

Figure 13 Scroll Control Register 2

Scroll Control Register 3 (R7)

The scroll control register 3 (Figure 14) includes bits SQ5, SQ4, SQ3, SQ2, SQ1, and SQ0.

SQ0 to SQ5: These bits designate the number of dots to be horizontally scrolled to the left on the panel. Horizontal smooth scroll can be performed for any number of dots between 1 and 48 inclusive by using the non-display DDRAM area. When these bits are 000000, scrolling is not performed. When these bits are 110000, 48 dots are scrolled to the left. If these bits are set to a value above 110000, 48 dots are still scrolled. Refer to Horizontal Smooth Scroll for details.

RAM Address Register (R8)

The RAM address register (Figure15) initially contains the RAM address at which incrementation (decrementation) starts. RAM selection bits (RM1/0) in the entry mode register (R0) select which RAM to access (DDRAM/CGRAM/SEGRAM). When DDRAM (RM1/0 = 00) is selected, address allocation differs according to the number of display lines, but in all cases the most significant bit (RA7) is ignored. During a 1-line display (NL1/0 = 00), addresses H'00 to H'4F are allocated to that line. During a 2-line display, addresses H'00 to H'27 are allocated to the first line, and addresses H'40 to H'67 are allocated to the second line. During a 4-line display, addresses H'00 to H'13 are allocated to the first line, H'20 to H'33 to the second, H'40 to H'53 to the third, and H'60 to H'73 to the fourth. See Table 14.

When CGRAM (RM1/0 = 10) is selected, addresses H'00 to H'19 are allocated to the first character and addresses H'20 to H'39 are allocated to the second character, and so on (Table 15). The setting of addresses between characters (example: H'1A to H'1F) is ignored here. When SEGRAM is selected (RM1/0 = 11), addresses H'0 to H'F are allocated to the RAM and the upper four bits (R4 to R7) are ignored (Table 16).

**Figure 14 Scroll Control Register 3****Figure 15 RAM Address Register**

Table 15 DDRAM Address Allocation

Displayed Lines	1-Line Display (NL1/0 = 00)	2-Line Display (NL1/0 = 01)	4-Line Display (NL1/0 = 00)
First line	H'00 to H'4F	H'00 to H'27	H'00 to H'13
Second line	—	H'40 to H'67	H'20 to H'33
Third line	—	—	H'40 to H'53
Fourth line	—	—	H'60 to H'73

Table 16 CGRAM Address Allocation

Displayed Character	CGRAM Address
First character	H'00 to H'19
Second character	H'20 to H'39
Third character	H'40 to H'59
Fourth character	H'60 to H'79
Fifth character	H'80 to H'99
Sixth character	H'A0 to H'B9
Seventh character	H'C0 to H'D9
Eighth character	H'E0 to H'F9

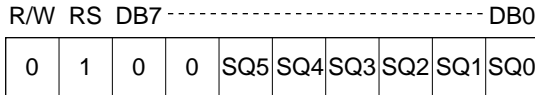
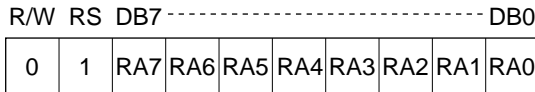
Table 17 SEGRAM Address Allocation

Displayed Segment	SEGRAM Address
SEG1 to SEG6	H'0
SEG7 to SEG12	H'1
SEG13 to SEG18	H'2
SEG19 to SEG24	H'3
SEG25 to SEG30	H'4
SEG31 to SEG36	H'5
SEG37 to SEG42	H'6
SEG43 to SEG48	H'7
SEG49 to SEG54	H'8
SEG55 to SEG60	H'9
SEG61 to SEG66	H'A
SEG67 to SEG72	H'B
SEG73 to SEG78	H'C
SEG79 to SEG84	H'D
SEG85 to SEG90	H'E
SEG91 to SEG96	H'F

Note: SEG72 to SEG96 are driven by extension drivers.

RAM Data Register (R9)

This register (Figure 16) stores 8-bit data that is written to or read from the DDRAM, CGRAM, or SEGRAM at the address indicated by the RAM address counter (RAC). The RAM selection bit (RM1/0) selects the RAM (DDRAM, CGRAM, SEGRAM). After the said RAM is accessed, RAM address is automatically incremented (decremented) by 1 according to the I/D bit.

Note that RAM selection bits (RM1/0) and RAM address register (R8) must be set before reading. If not, the first data read is invalid. If read instructions continue to be executed, however, data will be read correctly from the second read.

Test Register (RF)

This is a test register (Figure 17) and must be set to H'00 at all times. This register is automatically cleared (H'00) by reset input; however, it must be cleared by software after power-on if the reset pin is not used.

**Figure 16 RAM Data Register****Figure 17 Test Register**

Table 18 Instruction Registers

Reg. No.	Index (Hex)	Register	Code										Description	Execution Clock Cycle
			R/W	RS	DB7	DB6	DB5	DB4	DB3	DB2	DB1	DB0		
IR	—	Index (IDR)	0	0	—	—	—	—	ID3	ID2	ID1	ID0	Designates the register number of the instruction register to access. ID = 0000: R0 to 1001: R9	12
SR	—	Status (STR)	1	0	BF	NF1	NF0	—	LF3	LF2	LF1	LF0	Indicates the busy flag (BF), display read line position (NF1/0), display read raster-row position(NL0 to NL3).	0
R0	0	Entry mode (EMR)	0	1	0	0	0	0	0	I/D	RM1	RM0	Designates RAM address in incrementation or decrementation (I/D) and RAM selection (RM1/0).	12
R1	1	Function set (FSR)	0	1	0	BST	EXT2	EXT1	DT1	DT0	0	DCL	Clears display (DCL) and initializes the DDRAM address. Selects duty drive ratio(DT1/0), enables extension driver (EXT2/1) and sets the booster operation on.	DCL = 1: 492 Other: 12
R2	2	Cursor control (CCR)	0	1	0	0	0	0	CHM	C	CM1	CM0	Designates cursor-on (C) and cursor display mode(CM1/0). Executes cursor home (CHM) instruction.	12
R3	3	Display control 1 (DCR1)	0	1	0	0	0	0	0	ST	DC	DS	Designates standby mode (ST), character display on (DC), and segment display on (DS).	12
R4	4	Display control 2 (DCR2)	0	1	0	0	NC1	NC0	0	0	NL1	NL0	Sets the number of display characters(NC1/0) and display lines(NL1/0).	12
R5	5	Scroll control 1 (SCR1)	0	1	0	SN1	SN0	0	SL3	SL2	SL1	SL0	Sets the display start line (SN1/0) and start raster-row (ST0 to ST3).	12
R6	6	Scroll control 2 (SCR2)	0	1	0	0	PS1	PS0	SE4	SE3	SE2	SE1	Designates partial scroll columns (PS1/0) and scroll display line enable(SE1 to SE4).	12
R7	7	Scroll control 3 (SCR3)	0	1	0	0	SQ5	SQ4	SQ3	SQ2	SQ1	SQ0	Sets the number of dots to be scrolled (SQR0 to SQR5).	12

Table 18 Instruction Registers (cont)

Reg. No.	Index (Hex)	Register	Code										Description	Execution Clock Cycle
			R/W	RS	DB7	DB6	DB5	DB4	DB3	DB2	DB1	DB0		
R8	8	RAM address (RAR)	0	1	RA7	RA6	RA5	RA4	RA3	RA2	RA1	RA0	Resets the address address counter for DDRAM/CGRAM/SEGRAM. RAM is selected by RM1/0.	12
R9	9	RAM data (RDR)	0/1	1	RD7	RD6	RD5	RD4	RD3	RD2	RD1	RD0	Writes or reads data to and from DDRAM/CGRAM/SEGRAM. RAM is selected by RM1/0.	12
RF	F	Test (TSR)	0	1	0	0	0	0	0	0	0	0	This is a test register. Set 00 in this register.	12

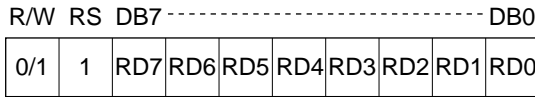
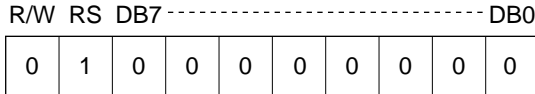
Note: The execution time depends on the input or oscillation frequency.

- BF = 1: Internal processing being performed
- NF1/0: Position of display read line
- LF0 to LF3: Position of display read raster-row
- ID= 1: Address increment
- = 0: Address decrement
- RM1/0: RAM selection (00/01: DDRAM, (10: GGRAM, 11: SEGRAM)
- BST = 1: Booster on
- EXT2 = 1: Common driver extension enable
- EXT1 = 1: Segment driver extension enable
- DT1/0: Duty ratio (00: 1/14, 01: 1/27, 10: 1/40, 11: 1/53)
- DCL = 1: Executes display-clear instruction
- CHM = 1: Executes cursor-home instruction
- C = 1: Cursor on
- CM1/0: Designates cursor mode (00: 12th raster-row, 01: blinking, 10: white/black inverse)
- ST = 1: Standby mode
- DC = 1: Character display on
- DS = 1: Segment display on
- NC1/0: Sets the number of display characters (6 to 40 characters)
- NL1/0: Sets the number of display lines (00: 1 line, 01: 2 lines, 11: 4 lines)
- SN1/0: Designates the line to start displaying (00: first line, 01: second line, 10: third line, 11: fourth line)
- SL0 to SL3: Designates scroll starting raster-row(0000: first raster-row, 1100: 13th raster-row)
- PS1/0: Designates partial scroll (00: all columns scroll, 01: the leftmost column fixed, 10: the two leftmost columns fixed, 11: the three leftmost columns fixed)
- SE1 to SE4: Designates which line to scroll (SE = 1: enables the first line to be scrolled, etc.)
- SQ0 to SQ5: Number of dots to scroll (0 to 48 dots)
- RA0 to RA7: RAM address
- RD0 to RD7: RAM data

Reset Function

The HD66730/1 is reset by setting the RESET pin to low level. During reset, the system performs next-control-register setting and executes instructions. The busy flag (BF) therefore indicates a busy state (BF = 1) at this time, which means that only the index register and status register can be accessed.

Display clear (DDRAM reset) is performed automatically by reset input. Since more than 1,000 clocks of execution cycles are needed to initialize the DDRAM, the reset period must be set to more than this number. Note that if the reset input conditions specified in Electrical Characteristics are not satisfied, the HD66730/1 will not operate correctly, and reset should be performed by software.

Initialization of Instruction Register Function

1. Index Register: IR

The index register cannot be initialized by reset. After reset release, the index register must be set to access a control register.

2. Status register: SR

BF = 1: Busy state

3. Entry mode register: R0

I/D = 1: +1 (incrementation)

RM1/0 = 00: DDRAM selection

4. Function set register: R1

BST = 0: Booster off

EXT2/1 = 11: Driver extension enable

DT1/0 = 11: 1/53 duty drive

DCL = 1: Display-clear execution

Note: At least 1,000 clock cycles of execution time is needed to clear the DDRAM.

5. Cursor control register: R2
 - CHM = 1: Cursor home execution
 - C = 0: Cursor display off
 - CM1/0 = 00: 12th raster-row cursor display mode
6. Display control register 1: R3
 - ST = 0: Standby mode clear
 - DC = 0: Character display off
 - DS = 0: Segment display off
7. Display control register 2: R4
 - NC1/0 = 00: 6-column display mode
 - NL1/0 = 00: 1-line display mode
8. Scroll control register 1: R5
 - SN1/0 = 00: Starts displaying from the first line.
 - SL3 to SL0 = 0000: Starts displaying from the first raster-row.
9. Scroll control register 2: R6
 - PS1/0 = 00: Partial scroll release
 - SE4 to SE1 = 0000: Disables dot scrolling for all lines.
10. Scroll control register 3: R7
 - SQ5 to SQ0 = 000000: Number of dots to be scrolled = 0
11. RAM address register: R8
 - RAM address register is automatically incremented during reset when display-clear is executed. Note that after reset is released, this register must be reset by software before accessing RAM.

Initial Setting of Pin Functions

1. Bus/serial interface

The input level of pin IM selects the 8-bit bus or serial interface. For an 8-bit bus interface, data is written into the index register or read from the status register according to the level of pin R/W. Note that pin RS must be held low during this time. For serial interface, data is written into the index register according to bit R/W. Note that bit RS must be 0 during this time. During reset, only the index register and status register can be set and RAM cannot be accessed.

2. LCD driver output

Since segment drivers (pins SEG1 to SEG71/119) are in a display-off state during reset, they output non-selective levels (V2/V3 level) during reset. At this time, a 4-line 6-character display alternates its current. Common drivers (pins COM1 to COM24/53 and COMS) output non-selective levels (V1/V4 level) during reset, and alternate its current for a 4-line 6-character display.

Note: Pins COM25/COMD of HD66730 are grounded (0V) during reset. When pin COM25 is used without expanding drivers to the common side, display may be performed using the liquid crystal drive voltage. In this case, adjust the liquid crystal voltage during reset.

3. Extension driver interface output (HD66730)

Since bits EXT2/1 are 11 during reset, extension is performed to both segment side and common side. Pin CL2 outputs the oscillation (operation) frequency clock. Pins CL1 and M output signals in a cycle corresponding to a 4-line 6-character display size. In addition, pins SEGD and COM25/COMD output low (ground level) since the display is turned off.

4. Booster output

The operation of the internal booster stops because bit BST becomes 0 during reset.

Note: The potential of pins V5OUT2 and V5OUT3 increases by about +0.7 V with respect to GND level when the booster stops. When using external polarized capacitors, make sure that no reverse bias occurs.

Interfacing to the MPU

The HD66730/1 enters 8-bit bus interface mode when the IM pin is set high. The HD66730/1 can interface with the MPU via an I/O port. Use the serial interface when there are restraints in the bus wiring width.

Instruction is executed when data is written into the control register. In this case, only the status register can be read (busy check, etc.). In this case, check the busy flag when accessing (polling), or insert an interval considering the execution time and perform the next access when the internal process has completely finished. The instruction execution time depends on the HD66730/1 operation frequency. When using the internal oscillation circuit of the HD66730/1, the instruction time will change as the oscillation frequency does. Figure 18 shows an example of an 8-bit data transfer timing sequence. Figure 19 shows an example of interface between HD66730/1 and 8-bit microcomputers.

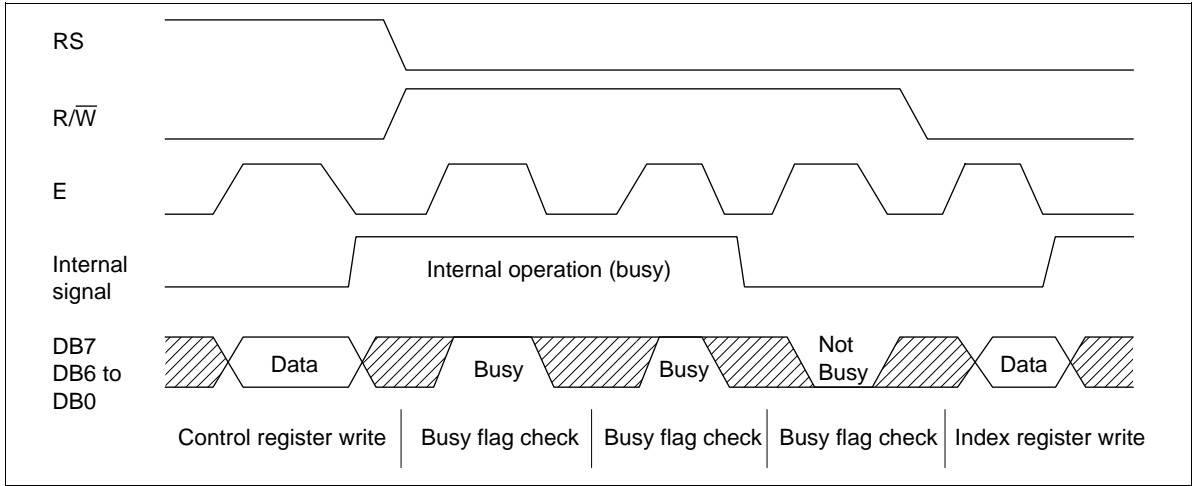

Figure 18 Example of an 8-bit Data Transfer Timing Sequence

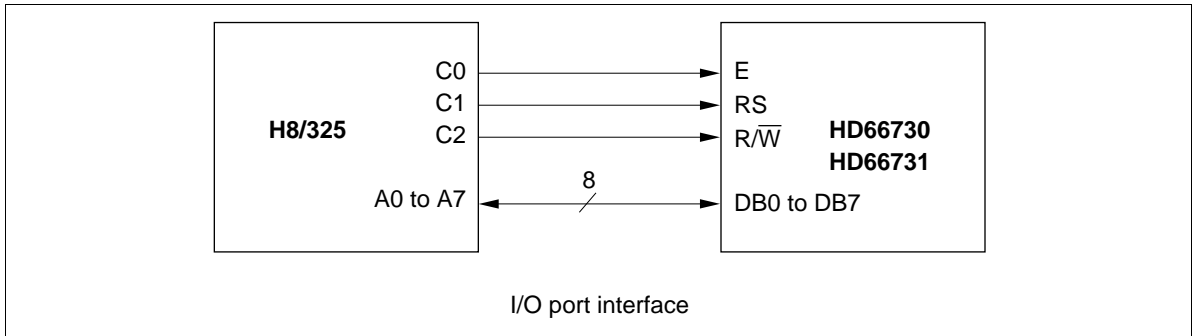

Figure 19 Example of Interfacing with 8-Bit Microcomputers

Transferring Serial Data

The HD66730/1 enters serial interface mode when the IM pin is set low. A three-line clock-synchronous transfer method is used. The HD66730/1 receives serial input data (SID) and transmits serial output data (SOD) by synchronizing with a transfer clock (SCLK) sent from the master side.

When the HD66730/1 interfaces with several chips, chip select pin (CS*) must be used. The transfer clock (SCLK) input is activated by making chip select (CS*) low. In addition, the transfer counter of the HD66730/1 can be reset and serial transfer synchronized by making chip select (CS*) high. Here, since the data which was being sent at reset is cleared, restart the transfer from the first bit of this data. In a minimum system where a single HD66730/1 interfaces to a single MPU, an interface can be constructed from the transfer clock (SCLK) and serial input data (SID). In this case, chip select (CS*) should be fixed to low.

The transfer clock (SCLK) is independent of operational clock (CLK) of the HD66730/1. However, when several instructions are continuously transferred, the instruction execution time determined by the operational clock (CLK) (see Continuous Transfer) must be considered since the HD66730/1 does not have an internal transmit/receive buffer.

Figure 20 shows the basic procedure for transferring serial data. To begin with, transfer the start byte. By receiving five consecutive bits of 1 (synchronizing bit string) at the beginning of the start byte, the transfer counter of the HD66730/1 is reset and serial transfer is synchronized. The 2 bits following the synchronizing bit string (5 bits) specify transfer direction (R/ \overline{W} bit) and register select (RS bit). Be sure to transfer 0 in the 8th bit.

After receiving the start byte, instructions are received and the data/busy flag is transmitted. When the transfer direction and register select remain the same, data can be continuously transmitted or received.

The transfer protocol is described in detail in the following.

a) Serial data input (receiving)

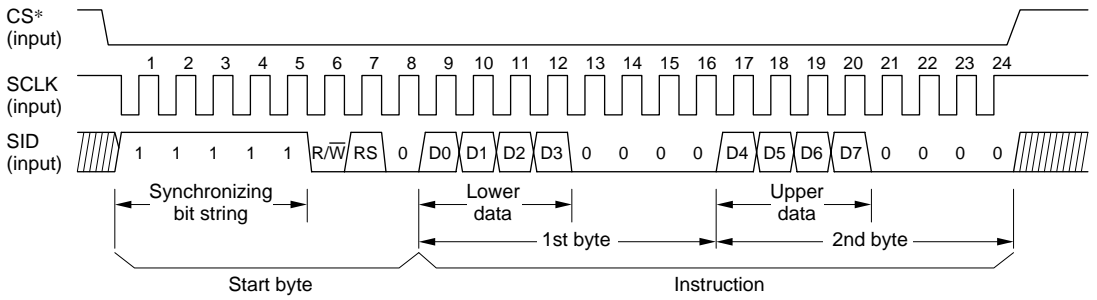

b) Serial data output (transmitting)

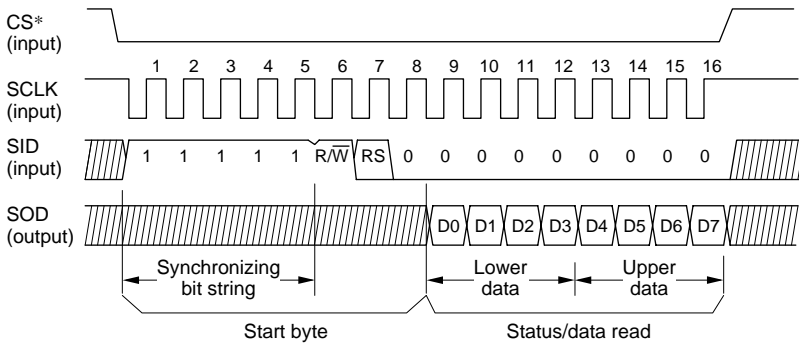

Figure 20 Basic Procedure for Transferring Serial Data

- Receiving (write)

After receiving the start synchronizing bit string, the R/W bit (= 0), and the RS bit in the start byte, an 8-bit instruction is received in 2 bytes: the lower 4 bits of the instruction are placed in the LSB of the first byte, and the higher 4 bits of the instruction are placed in the LSB of the second byte. Be sure to transfer 0 in the following 4 bits of each byte. When instructions are received with R/W bit and RS bit unchanged, continuous transfer is possible (see Continuous Transfer in the following).

- Transmitting (read)

After receiving the synchronizing bit string, the R/W bit (= 0), and the RS bit in the start byte, 8-bit read data is transmitted from pin SOD in the same way as receiving. When read data is transmitted with R/W bit and RS bit unchanged, continuous transfer is possible (see Continuous Transfer in the following).

The status register (SR) is read when the RS bit is 0. RAM data is read out when the RS bit is set to 1 after designating RAM data register (R9) with the index register (IR). Bits RM1/0 of entry mode register (R0) select the RAM. When reading RAM data, an interval longer than the RAM reading time must be taken after the start byte has been accepted and before the first data has been read out. During transmission (data output), the SID input is continuously monitored for a start synchronizing bit string (1111). Once this has been detected, the R/\bar{W} and RS bits are received. Accordingly, 0 must always be input to SID when transmitting data continuously.

- Continuous Transfer

When instructions are received with the R/W bit and RS bit unchanged, continuous receive is possible without inserting a start byte between instructions.

After receiving the last bit (the 8th bit in the 2nd byte) of an instruction, the system begins to execute it. To execute the next instruction, the instruction execution time of the HD66730/1 must be considered. If the last bit (the 8th bit in the 2nd byte) of the next instruction is received during execution of the previous instruction, the instruction will be ignored.

In addition, if the next unit of data is read before read execution of previous data is completed for RAM data, normal data is not sent. To transfer data normally, the busy flag must be checked. However, if the amount of wiring used for transmission needs to be reduced, or if the burden of polling on the CPU needs to be lightened, transfer can be performed without reading the busy flag. In this case, insert a transfer wait between instructions so that the current instruction has time to complete execution. Figure 21 shows the procedure for continuous data transfer.

i) Continuous data write by polling processing

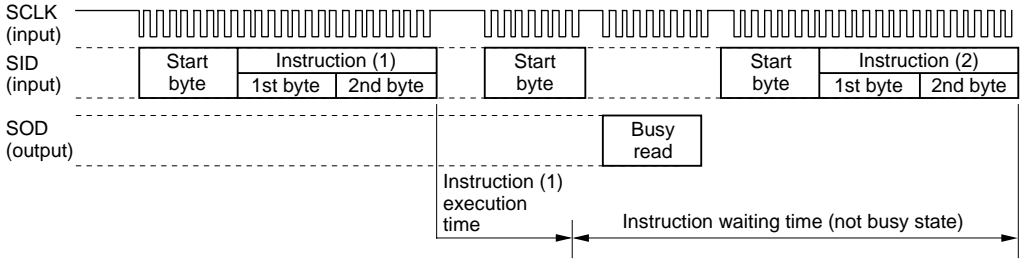

ii) Continuous data write by CPU wait insert

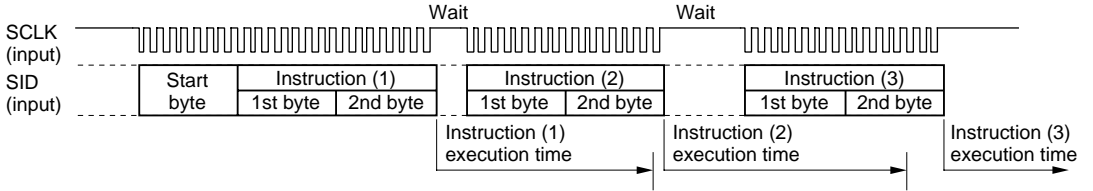

iii) Continuous data write by CPU wait insert

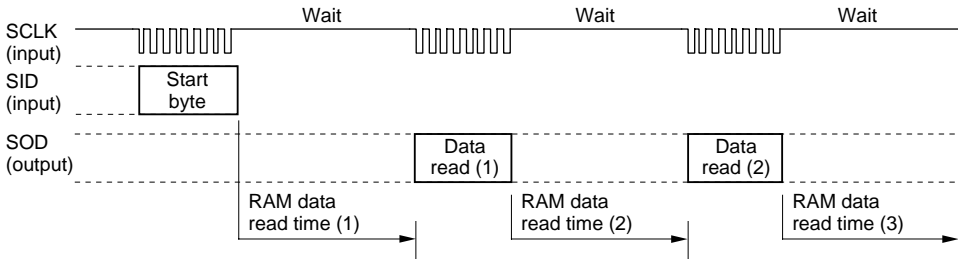

Figure 21 Procedure for Continuous Data Transfer

Combined Display of Full-Size and Half-Size Characters

The HD66730/1 performs display from the left edge of the display combining 12-dot full-size (character size: 11 × 12 dots) and 6-dot half-size characters (character size: 6 × 12 dots). There will be a one-dot space between these fonts.

The most significant bit in the data (8 bits) in DDRAM is allocated to the designation bit indicating a full-size or half-size character. When this MSB is 0, the full-size character is selected, and when 1, the half-size character is selected.

When the full-size character is selected, 2 bytes of DDRAM are linked and used as a 16-bit code (Figure 22). In this case, the lower byte is written into the smaller DDRAM address. 12 bits of this 16-bit code are used as character codes. Up to 4096 character codes can be specified. In addition, two of the remaining four bits can be allocated to a display-attribute code and can designate white/black inverted display for individual characters (refer to Display Attribute Designation). Table 18 shows the relationship between the 16-bit designated JIS code and the HD66730/1 12-bit character code. 8-bit data designating half-size characters are used as an 8-bit code (Figure 23). Specifically, 7 bits of the 8-bit half-size characters become the character codes, so that a total of 128 characters can be displayed (alphanumeric characters and symbols can be displayed as half-size characters).

User fonts can be displayed using the CGRAM. Special symbols not included in the internal CGROM or the JIS Level-2 Kanji Set can be displayed as needed. Since the display font size of the CGRAM is 12 × 13 dots, CGRAM fonts can be displayed to the right, left, top or bottom, in order to be used to display double-size characters or graphics. Note that the display-attribute code (A1/A0) designation that is to be written into the DDRAM is ignored when the CGRAM is used. In this case, bits 6 and 7 in the CGRAM are used for display-attribute-code designation. Refer to CGRAM for details.

Table 19 Relationship between JIS Codes and HD66730 Character Codes

- JIS first byte code: b1 to b7 (7 bits)
- JIS second byte code: a1 to a7 (7 bits)
- CGRAM address for user fonts: u0 to u2 (3 bits)

Character Code Arrangement of HD66730

JIS	b7	b6	b5	C11	C10	C9	C8	C7	C6	C5	C4	C3	C2	C1	C0
Non-kanji	0	1	0	a7	a6	b3	b2	b1	0	0	a5	a4	a3	a2	a1
Level 1 kanji	0	1	1	b7	b4	b3	b2	b1	a7	a6	a5	a4	a3	a2	a1
Level 1 kanji	1	0	0	b7	b4	b3	b2	b1	a7	a6	a5	a4	a3	a2	a1
User font	—	—	—	0	0	0	0	0	0	0	0	0	u2	u1	u0

Upper byte
Lower byte

Full-size character format

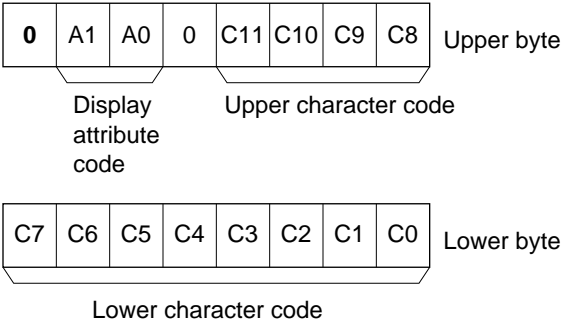

Display attribute code: A1/A0 (2 bits)
MSB LSB
Character code: C11 to C0 (12 bits)

Figure 22 Full-Size Character Codes

Half-size character format

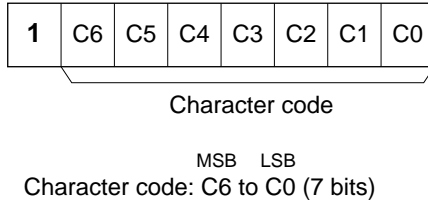

Figure 23 Half-Size Character Codes

An example of displaying full-size and half-size characters together is described here.

Full-size character display conforms to JIS (16 bits). Perform code conversion (16 bits → 12 bits) according to the relationship between the 16-bit JIS code and the HD66730/1 12-bit character code and write two-byte character data to the DDRAM (write the lower byte to the smaller DDRAM address). The example is shown in Table 19. When displaying a half-size character, refer to Table 5 the HD66730/1 Half-size Font List and write one-byte character data into the DDRAM. The example is shown in Table 20.

Figure 24 shows how to set data to the DDRAM when performing a 2-line display and Figure 25 shows the resulting liquid crystal display.

Table 20 Example of Full-Size Font Conversion

Displayed Character	JIS Code (First/Second Byte)	Character Code (C11 to C0)
東	45/6C (Hex)	AEC (Hex)
京	35/7E (Hex)	2FE (Hex)
都	45/54 (Hex)	AD4 (Hex)
小	3E/2E (Hex)	72E (Hex)
平	4A/3F (Hex)	D3F (Hex)
市	3B/54 (Hex)	5D4 (Hex)
本	4B/5C (Hex)	DDC (Hex)
町	44/2E (Hex)	A2C (Hex)
の	24/4E (Hex)	A0E (Hex)

Table 21 Example of Half-Size Font Code

Display Character	Character Code (C0 to C11)
1	31 (Hex)
2	32 (Hex)
0	30 (Hex)
,	2C (Hex)
M	4D (Hex)
C	43 (Hex)

0: Full-size designation
1: Half-size designation

Address	00 (Hex)	01 (Hex)	02 (Hex)	03 (Hex)	04 (Hex)	05 (Hex)	06 (Hex)	07 (Hex)	08 (Hex)	09 (Hex)	0A (Hex)	0B (Hex)	---
1st-line data	1110	0000	1111	0000	1101	0000	0010	0000	0011	0000	1101	0000	---
	1100	1010	1110	0010	0100	1010	1110	0111	1111	1101	0100	0101	---
	東		京		都		小		平		市		

Address	40 (Hex)	41 (Hex)	42 (Hex)	43 (Hex)	44 (Hex)	45 (Hex)	46 (Hex)	47 (Hex)	48 (Hex)	49 (Hex)	4A (Hex)	4B (Hex)	---
2nd-line data	1101	0000	0010	0000	1011	0000	0000	1011	1011	1010	1100	1100	---
	1100	1101	1110	1010	0001	1110	1010	0010	0000	1100	1101	0011	---
	本		町		1		の		2		0 , M C		

Figure 24 Example of DDRAM Character Code (2-Line Display Mode)

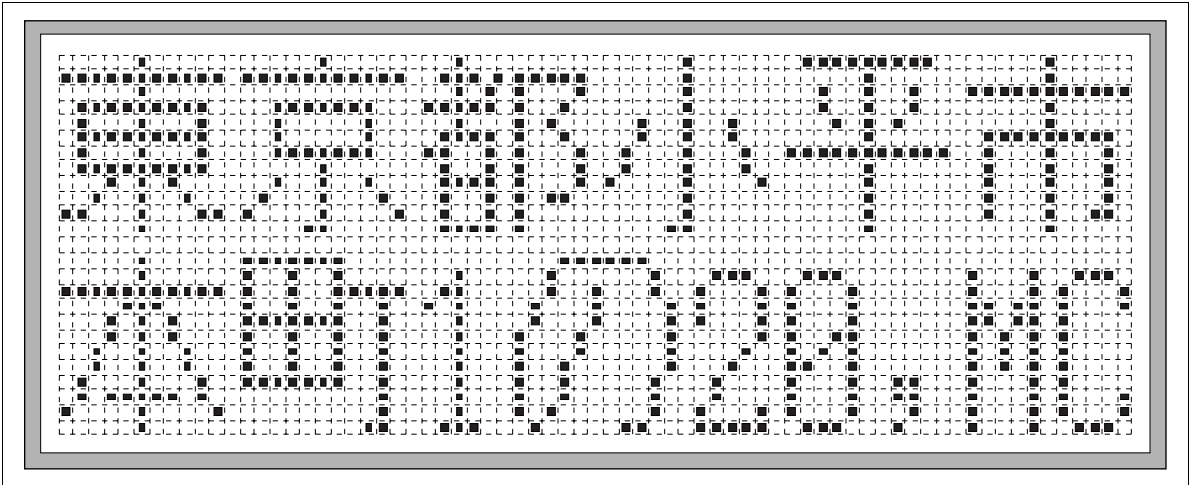

Figure 25 Example of Liquid Crystal Display

Display Attribute Designation

The HD66730/1 allocates 12 bits of the full-size 16-bit code character to an abbreviated character code and 2 bits to a display-attribute code (Figure 26). White/black inverted display, blinking display, and white/black inverted blinking display can be designated for each full-size character (Table 21). Display attribute control is performed for a 12 × 13 dot matrix unit that includes a 11 × 12 dot full-size character and a column of dots to the right and a row of dots to the bottom (Figure 27). The blinking cycle for blinking display and white/black inverted blinking display is 64 frames. Blinking display is performed by changing the display pattern every 32 frames. Since the 8-bit code designated for half-size characters cannot accommodate a display attribute, they will always be displayed normally.

Table 22 Display Attribute Designation

A1	A0	Display State
0	0	Normal display
0	1	White/black inverted display
1	0	Blinking display
1	1	White/black inverted blinking display

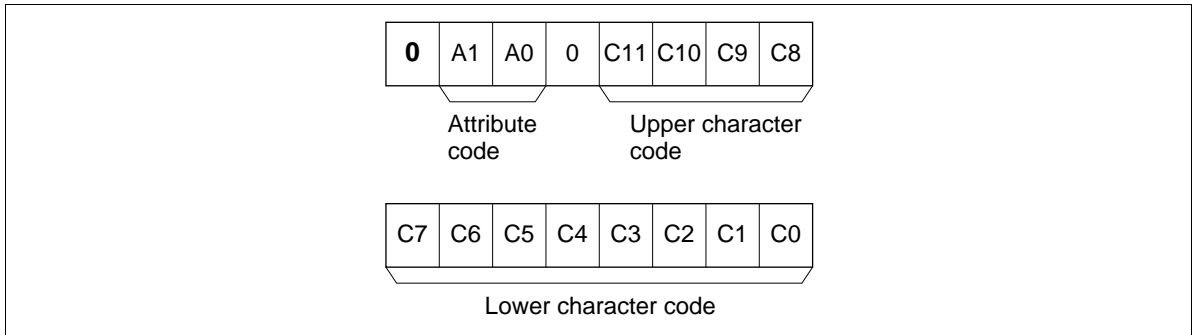
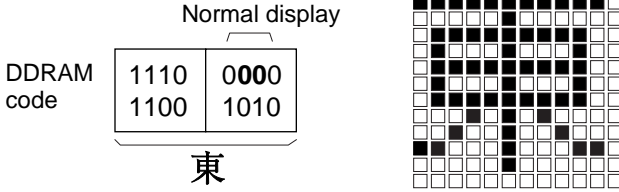
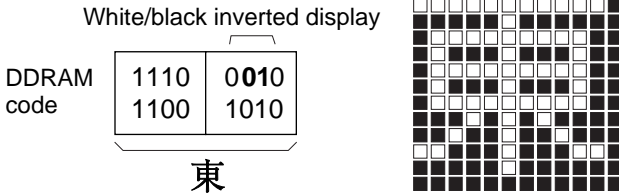

Figure 26 Full-Size Code Format

a) Example of normal display



b) Example of white/black inverted display



c) Example of blinking display

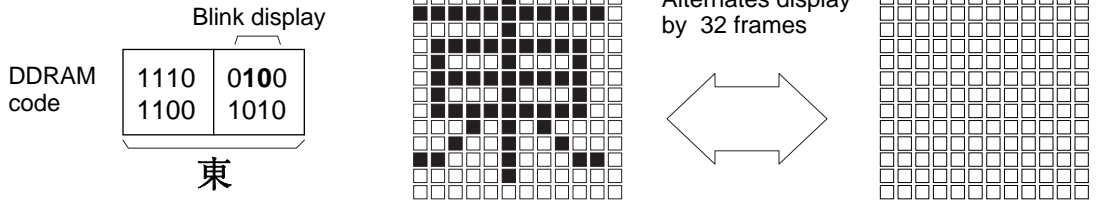

d) Example of white/black inverted blinking display

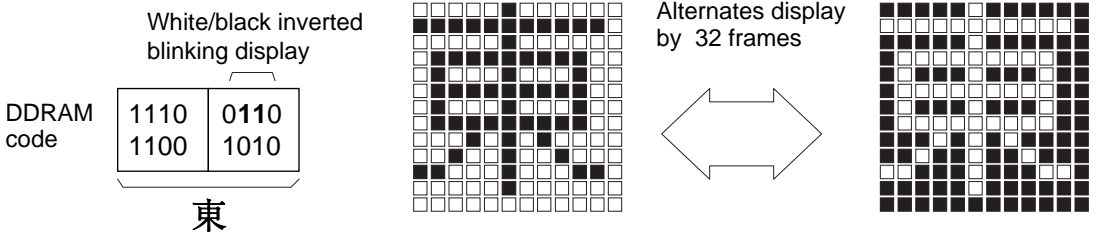

Figure 27 Setting Codes in the DDRAM and Display Examples

Horizontal Smooth Scroll

Data shown on the display can be scrolled horizontally to the left for a specified number of dots (Figure 28). The number of dots are set in scroll control register 3 (SCR3: R7), and the display lines to be scrolled are designated by the display line enable bits (SE1/SE2/SE3/SE4) in scroll control register 2 (SCR2: R6). Because the number of dots that can be set for scrolling here is 48, scrolling for more than this number can be achieved by shifting to the left by four characters of character code data in DDRAM for the scroll display line in question, rewriting the characters, and then scrolling again. When rewriting DDRAM while displaying characters, however, character output will momentarily breakdown, and the display may flicker. In this case, first check which display lines are currently being displayed by referring to NF1/0 (line 1 to the line 4) and display raster-rows LF0 to LF3 (raster-row 1 to raster-row 13) in the status register, and then rewrite a DDRAM line that is not being displayed. Keep in mind that scroll display line enable bits (SE1 to SE4) can be used to designate those display lines for which horizontal smooth scroll is desired.

In partial scroll, one to three leftmost characters on the display as specified by the partial scroll bits (PS1/0) of the scroll control register 2 (SCR: R6) are fixed and the remaining characters undergo a smooth scroll to perform partial smooth scroll.

When performing horizontal smooth scroll, the number of characters to be displayed (NC1/0: R4) must be at least 4 characters more than the number of characters actually displayed on the liquid crystal display. For example, set 10 or more display characters (NC1/0) for a single-chip 6-character display.

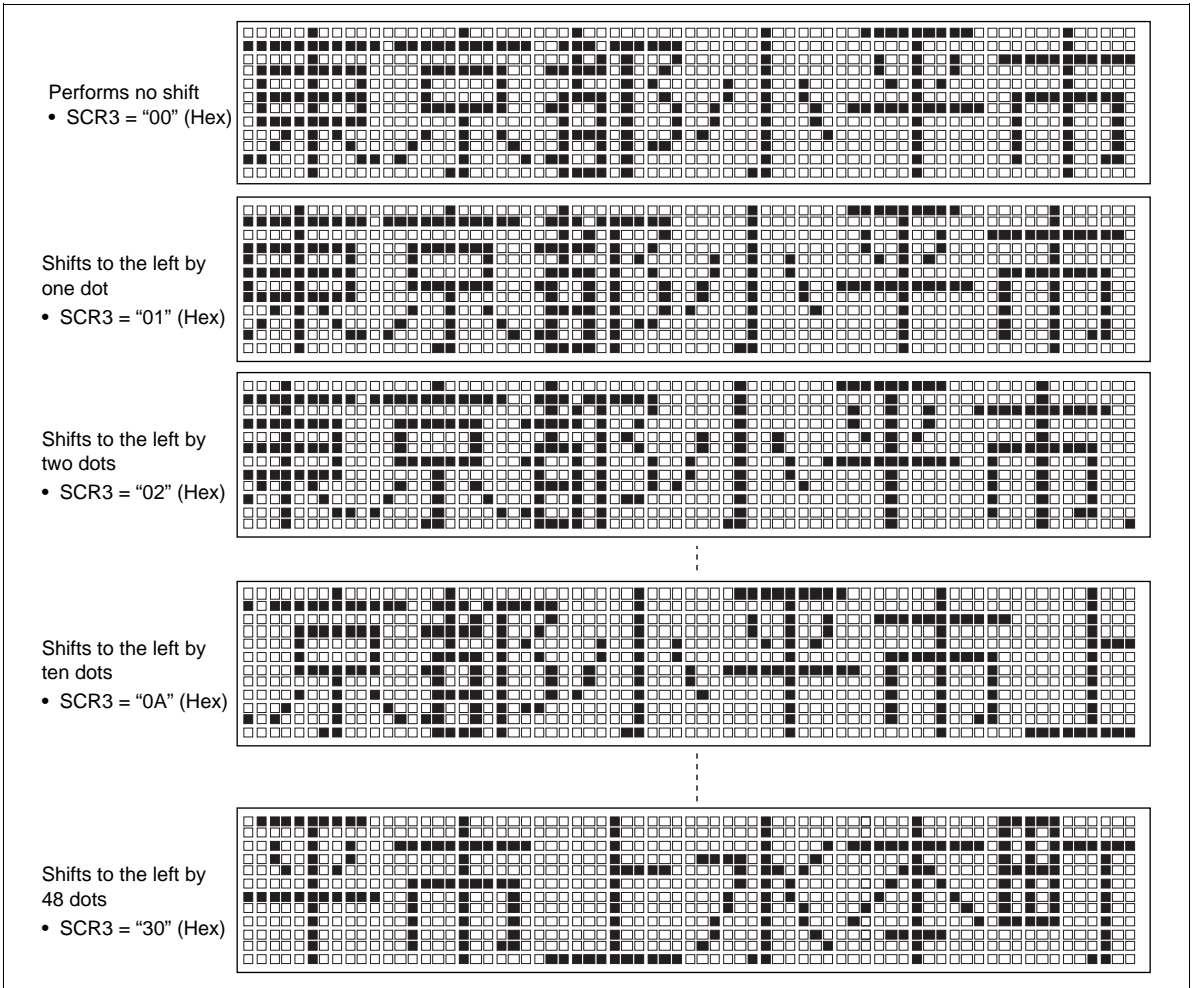

Figure 28 Example of Horizontal Smooth Scroll Display

Examples of Register Setting

	R/W	RS	DB7	DB6	DB5	DB4	DB3	DB2	DB1	DB0	
1	0	0	0	0	0	0	0	1	1	0	Index register set (R6 designation)
2	0	1	0	0	0	1	0	0	1	0	Enables scroll (scrolls only the second line)
3	0	0	0	0	0	0	0	1	1	1	Index register set (R7 designation)
4	0	1	0	0	0	0	0	0	0	1	Shifts the second line to the left by one dot
CPU Wait											
5	0	1	1	0	0	0	0	0	1	0	Shifts the second line to the left by two dots
CPU Wait											
6	0	1	1	0	0	0	0	0	1	1	Shifts the second line to the left by three dots
CPU Wait											
⋮											
51	0	1	1	0	1	1	0	0	0	0	Shifts the second line to the left by 48 dots*

Note: The number of dots that can be specified for scrolling is 48. Scrolling for more than this number can be achieved by rewriting DDRAM data and scrolling again from dot 0.
 Note that the number of characters shown on the LCD and the number of scroll characters must be less than the number of maximum display characters (1-line display mode: 40 characters, 2-line display mode: 20 characters, 4-line display mode: 10 characters).

Figure 29 Example of Executing Smooth Scroll to the Left

	R/W	RS	DB7	DB6	DB5	DB4	DB3	DB2	DB1	DB0	
1	0	0	0	0	0	0	0	1	1	0	Index register set (R6 designation)
2	0	1	0	0	0	1	0	0	1	0	Enables scroll (scrolls only the second line)
3	0	0	0	0	0	0	0	1	1	1	Index register set (R7 designation)
4	0	1	1	0	1	1	0	0	0	0	Shifts the second line to the left by 48 dots*
CPU Wait											
5	0	1	1	0	1	0	1	1	1	1	Shifts the second line to the left by 47 dots
CPU Wait											
⋮											
49	0	1	1	1	0	0	0	0	0	1	Shifts the second line to the left by one dot
CPU Wait											
51	0	1	1	0	0	0	0	0	0	0	Perform no shift

Note: The number of dots that can be specified for scrolling is 48. Rewrite 48 dots (4 characters) of data inside the DDRAM and shift them to the right before scrolling. Scrolling for more than this number can be achieved by rewriting the data of DDRAM and begin scrolling from dot 48 again. Note that the number of characters shown on the LCD and the number of scroll characters must be less than the number of maximum display characters (1-line display mode: 40 characters, 2-line display mode: 20 characters, 4-line display mode: 10 characters).

Figure 30 Example of Executing Smooth Scroll to the Right

Partial Smooth Scroll

Partial smooth scroll displays one to three leftmost characters as fixed while the remaining ones undergo a horizontal smooth scroll in the left and right direction. Specifically, the number of leftmost characters to be fixed is specified by the partial scroll bits (PS1/0) in the scroll control register 2 (SCR2: R6). For example, when bits PS1/0 are 10, the two leftmost characters are fixed; when 11, the three leftmost characters are fixed.

Although half-size characters can be displayed in a fixed display area, they must be displayed in even-numbered groups of two, four or six characters. Figure 31 shows an example of smooth scroll performed in a display when bits PS1/0 are set to 10. The two leftmost characters (住所) are displayed as fixed, and the remaining four characters undergo a smooth scroll.

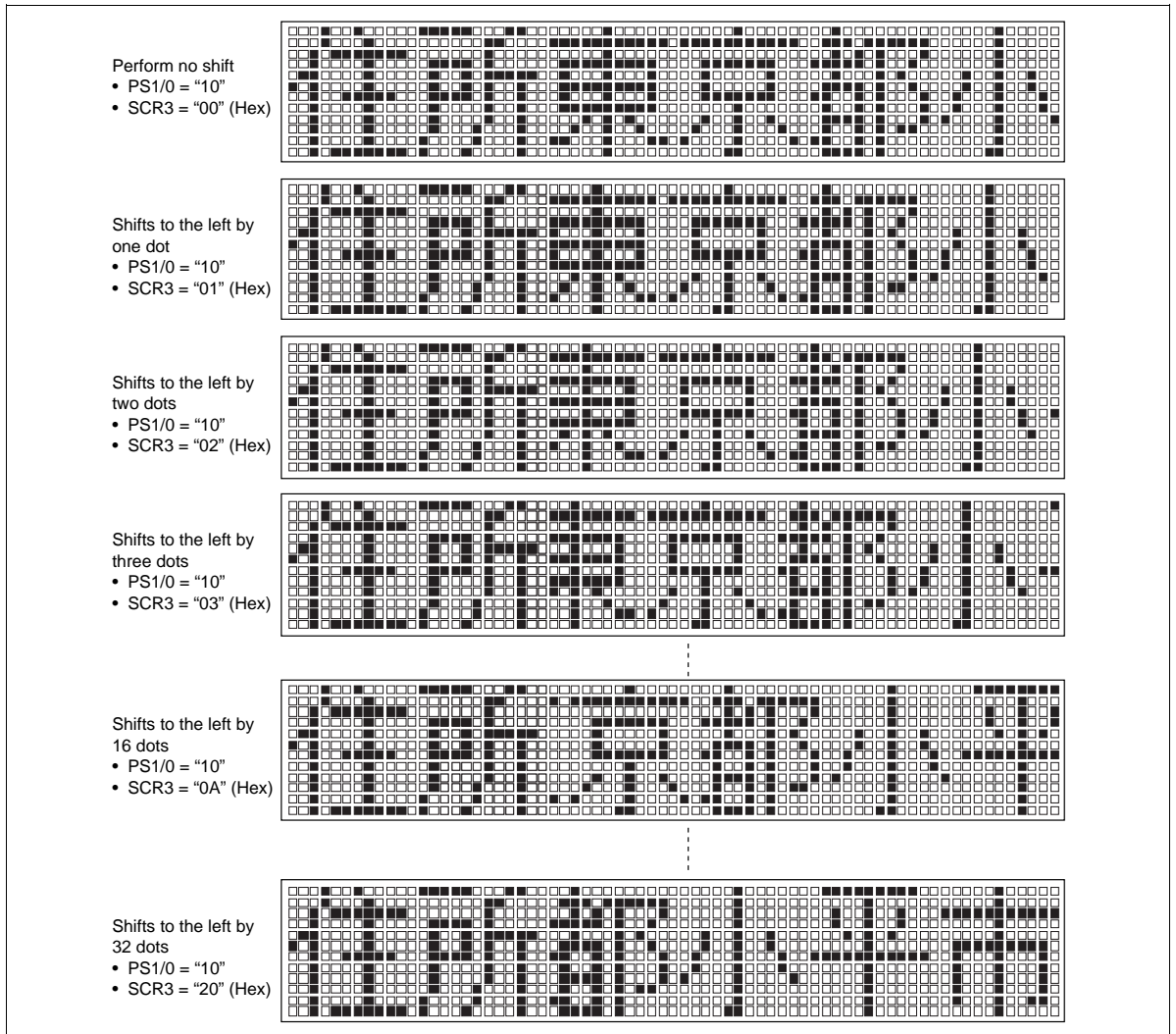

Figure 31 Example of Partial Smooth Scroll Display

Vertical Smooth Scroll

Vertical smooth scroll up and down can be performed by setting the number of display lines (NL1/0: R4) to a value greater than the actual number of liquid crystal display lines, which can be set by the duty drive ratio (DT1/0: R1) to 1/14 (1-line display), 1/27 (2-line display), 1/40 (3-line display), or 1/53 (4-line display). The display line setting (NL1/0: R4), which controls the display, can select 1-line display mode, 2-line display mode, or 4-line display mode.

For example, to perform normal vertical smooth scroll for a 3-line liquid crystal display with a duty ratio of 1/40, set the number of display lines (NL1/0: R4) to 4 lines. Note that if vertical smooth scroll is performed when the number of actual liquid display lines is the same as the number of set display lines, the display line that has scrolled out of the display will appear again from the bottom (or the top) (this function is called lap-around). In a 4-line crystal liquid display, only the lap-around function can be performed. Vertical smooth scroll is controlled by incrementing or decrementing the display line (SN1/0), which indicates which line to start from, and the display raster-row (SL0 to SL3). For example, when performing smooth scroll up, the display raster-row (SL0 to SL3) is incremented from 0000 to 1100 in order to scroll 12 raster-rows. Moreover, by incrementing the display line (SN1/0) and then incrementing the display raster-row from 0000 to 1100 again, a total of 25 raster-rows can be scrolled. Since the DDRAM is only 80 bytes, its data must be rewritten when performing continuous scroll exceeding this capacity.

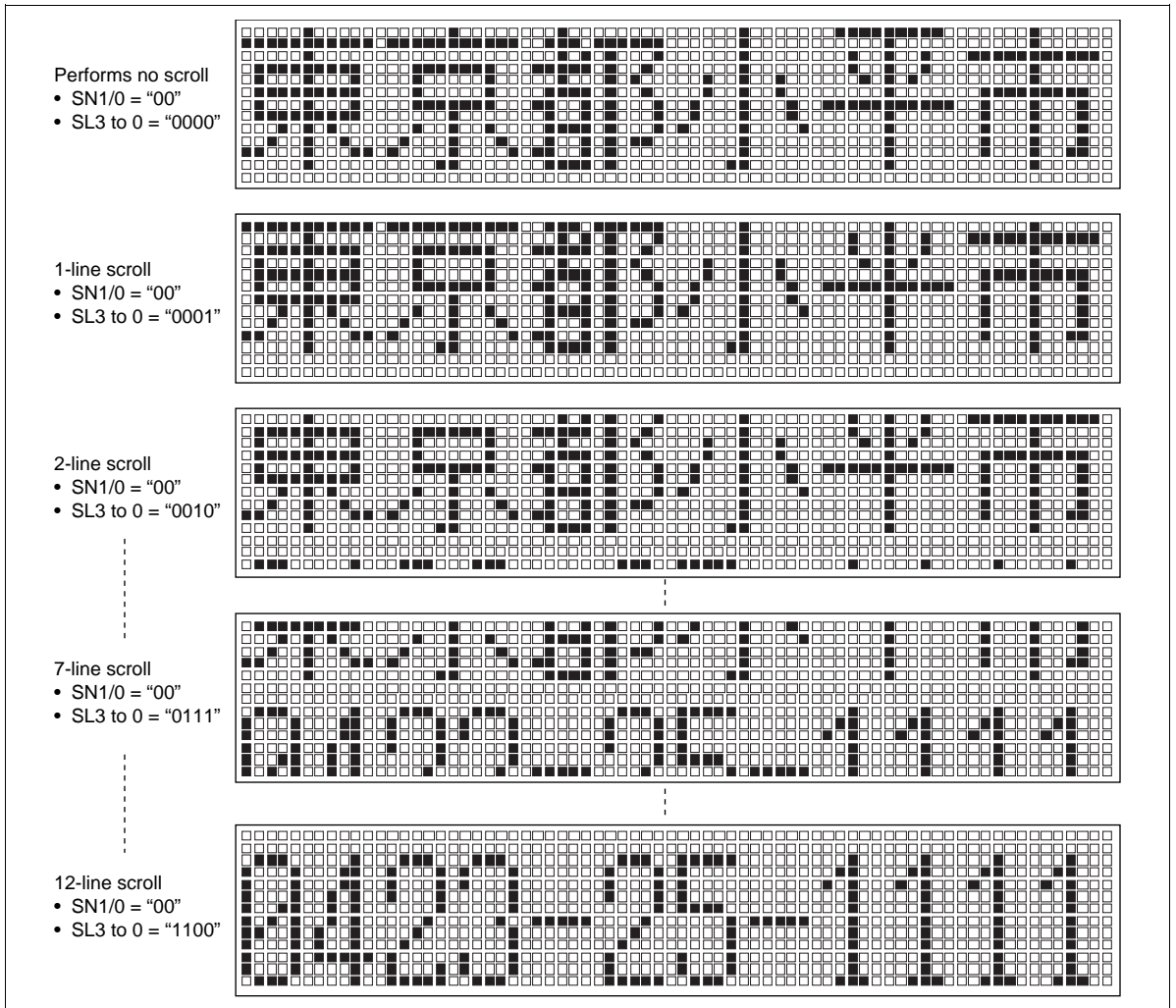

Figure 32 Example of Vertical Smooth Scroll Display

Examples of Register Setting (2-Line Liquid Crystal Drive: DT1/0 = 01, 4-Line Display Mode: NL1/0 = 11)

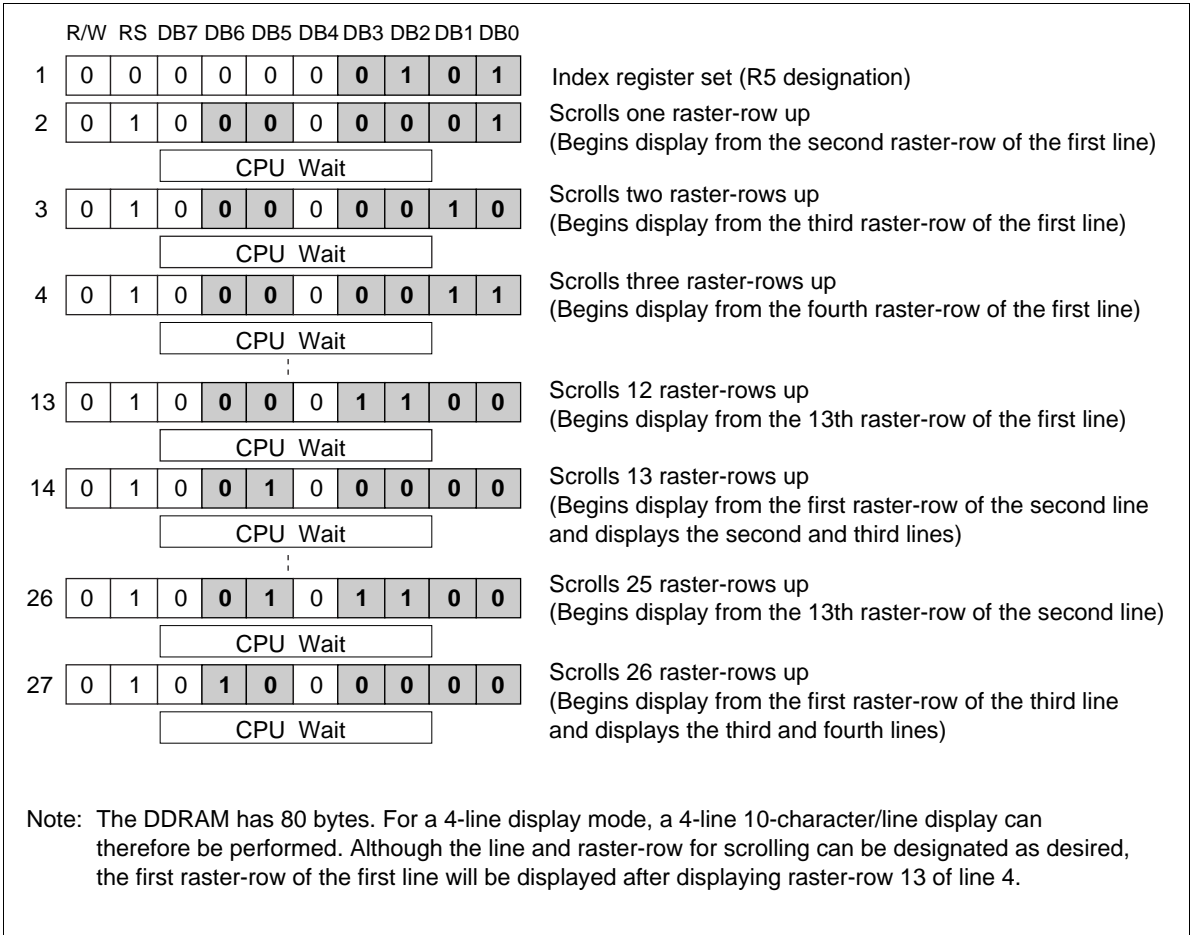

Figure 33 Example of Performing Smooth Scroll Up

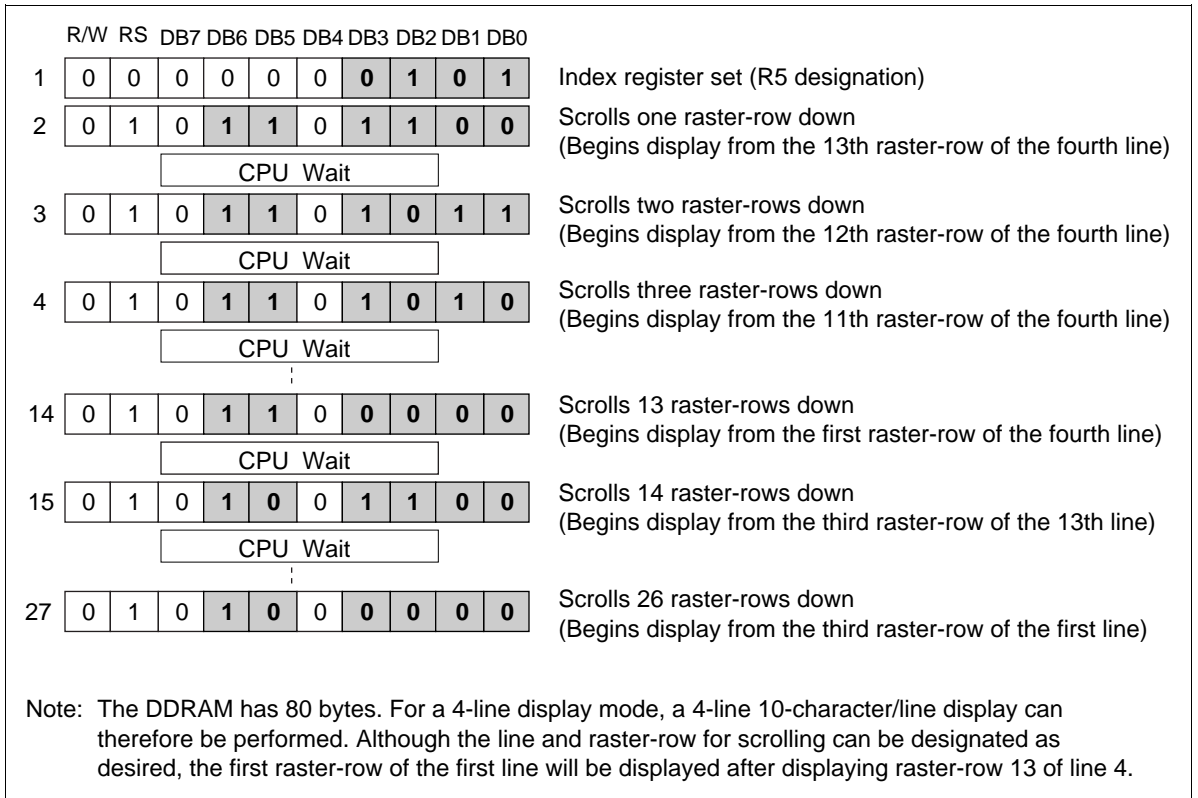

Figure 34 Example of Performing Smooth Scroll Down

Extension Driver LSI Interface (HD66730)

The HD66730 can interface with extension drivers using extension driver interface signals CL1, CL2, D, and M output from the HD66730, increasing the number of display characters (Figure 35). Although the liquid crystal driver voltage that drives the booster of the HD66730 can also be used as the driver power supply of extension drivers, the output voltage drop of the booster increases as the load of the booster increases.

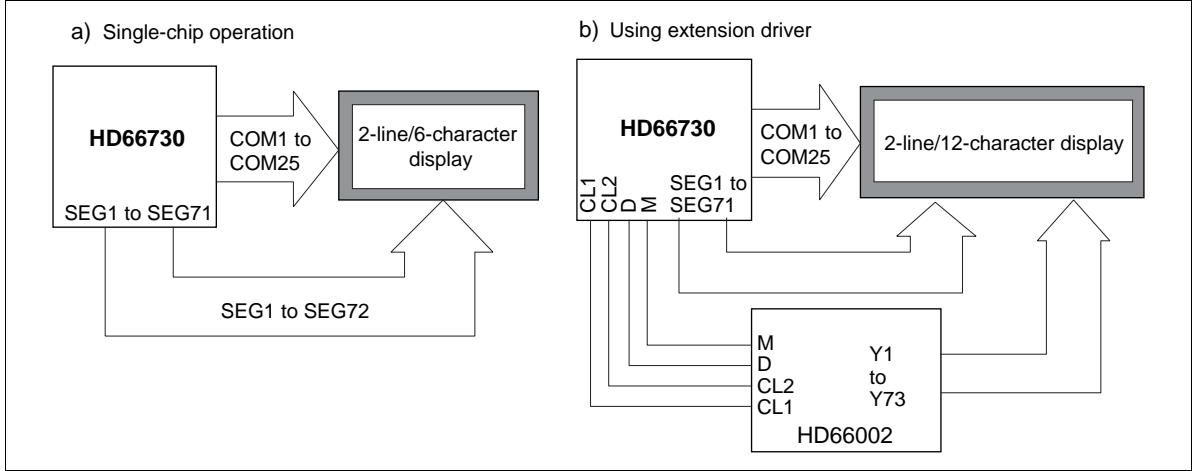

Figure 35 HD66730 and Extension Driver LSI Connection

Interfacing with the Liquid Crystal Panel

By connecting the HD66730 to extension drivers, the display can be expanded up to a 1-line/40-character, 2-line/20-character, or a 4-line/10-character display configuration. Bits DT1/0 set the duty drive ratio and bits NC1/0 set the number of characters per line. In addition, bits NL1/0 sets the number of display lines during display read control. Table 22 shows the relationship between the number of characters actually displayed on the liquid crystal panel and the corresponding number of extension drivers needed.

Table 23 Relationship between the Number of Liquid Crystal Display Characters and Extension Drivers

Display Lines	Number of Display Characters per Line						Duty Drive
	6 Characters	10 Characters	12 Characters	16 Characters	20 Characters	40 Characters	
1 line	(0/0)	(2/0)	(2/0)	(3/0)	(5/0)	(11/0)	1/14
2 lines	(0/0)	(2/0)	(2/0)	(3/0)	(5/0)	Display disabled	1/27
3 lines	(0/1)	(2/1)	Display disabled	Display disabled	Display disabled	Display disabled	1/40
4 lines	(0/1)	(2/1)	Display disabled	Display disabled	Display disabled	Display disabled	1/53

- Notes:
1. Numbers in parentheses = (number of extension segment drivers/number of common drivers)
 2. This is an example when using the 40 output extension drivers, and when N_h represents display characters and N_d extension driver outputs, the number of extension drivers needed can generally be calculated as follows:

$$[\text{Number of extension drivers}] = (12 * N_h - 71 - 1)/N_d \uparrow$$
 3. The right-edge segment (space between characters) is not displayed in 6-character or 16-character display.
 4. Horizontal smooth scroll cannot be performed during an 1-line/40-character, 2-line/20-character, 3-line/10-character, or 4-line/10-character display.

Example of Interfacing with a 1-Line Display Panel

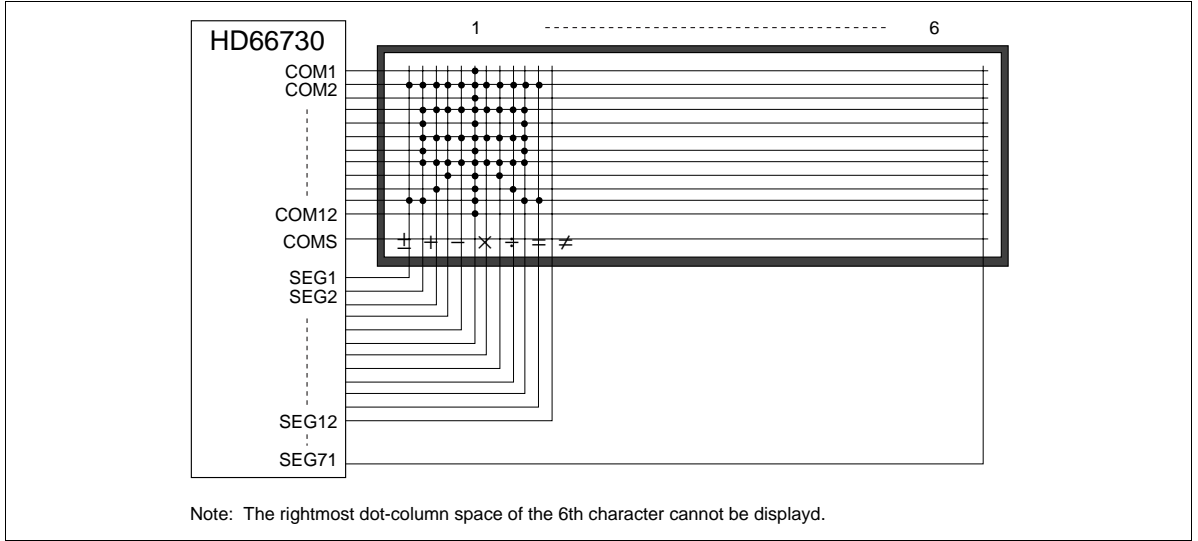

Figure 36 Example of 1-Line/6-Character + 71-Segment Display (Using 1/14 Duty)

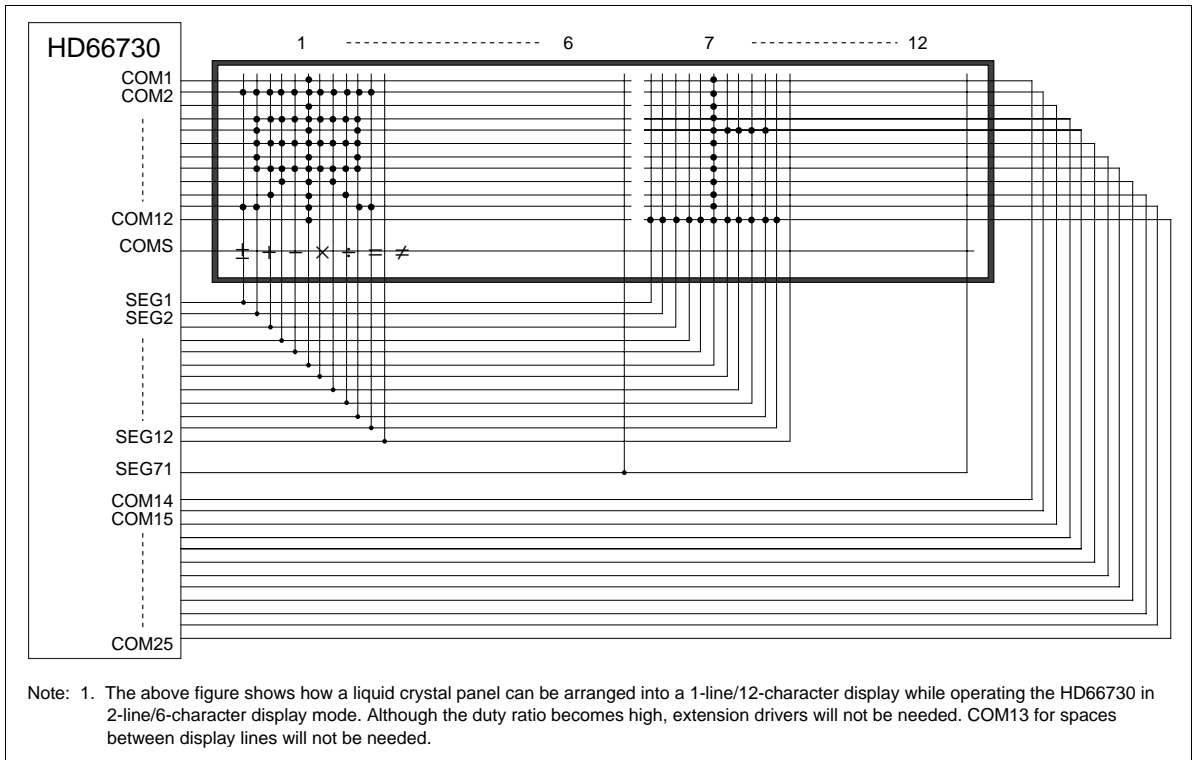

Figure 37 Example of 1-Line/12-Character + 71-Segment Display (Using 1/27 Duty)

Example of Interfacing with a 2-Line Display Panel

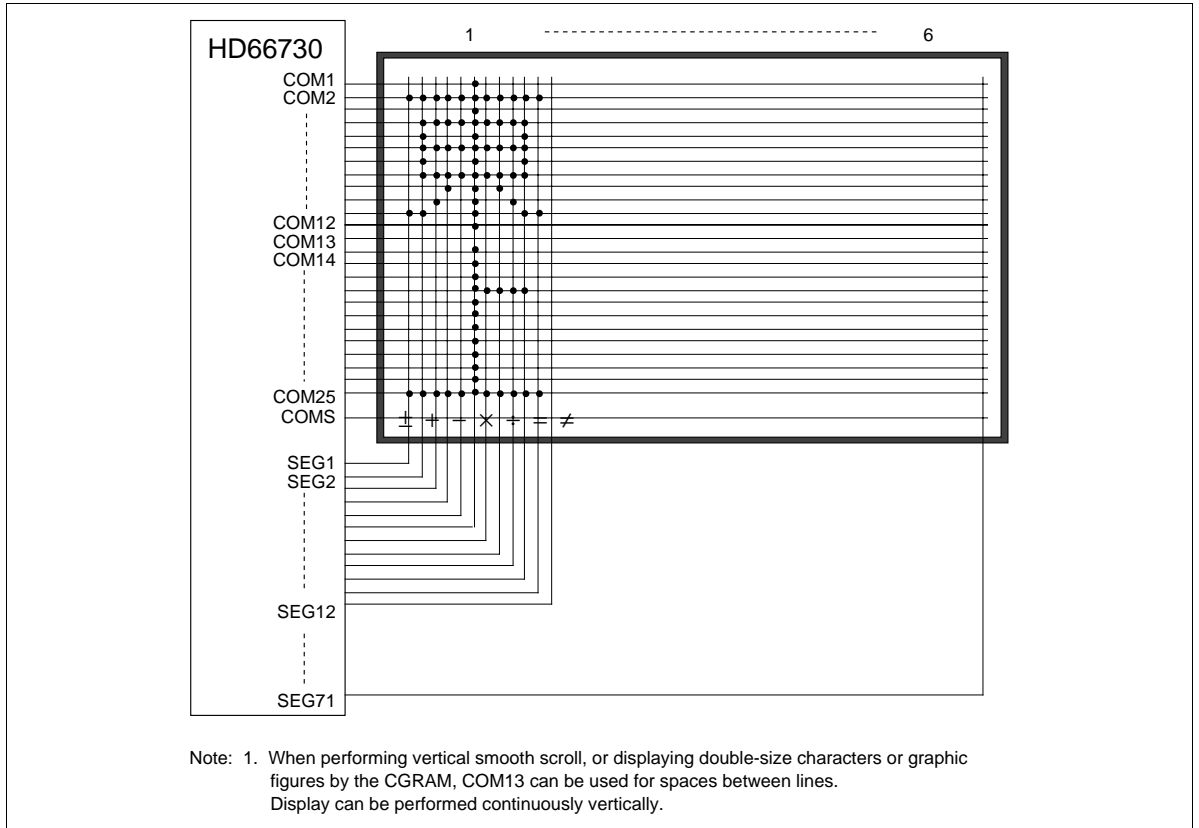

Figure 38 Example of 2-Line/6-Character + 71-Segment Display (Using 1/27 Duty)

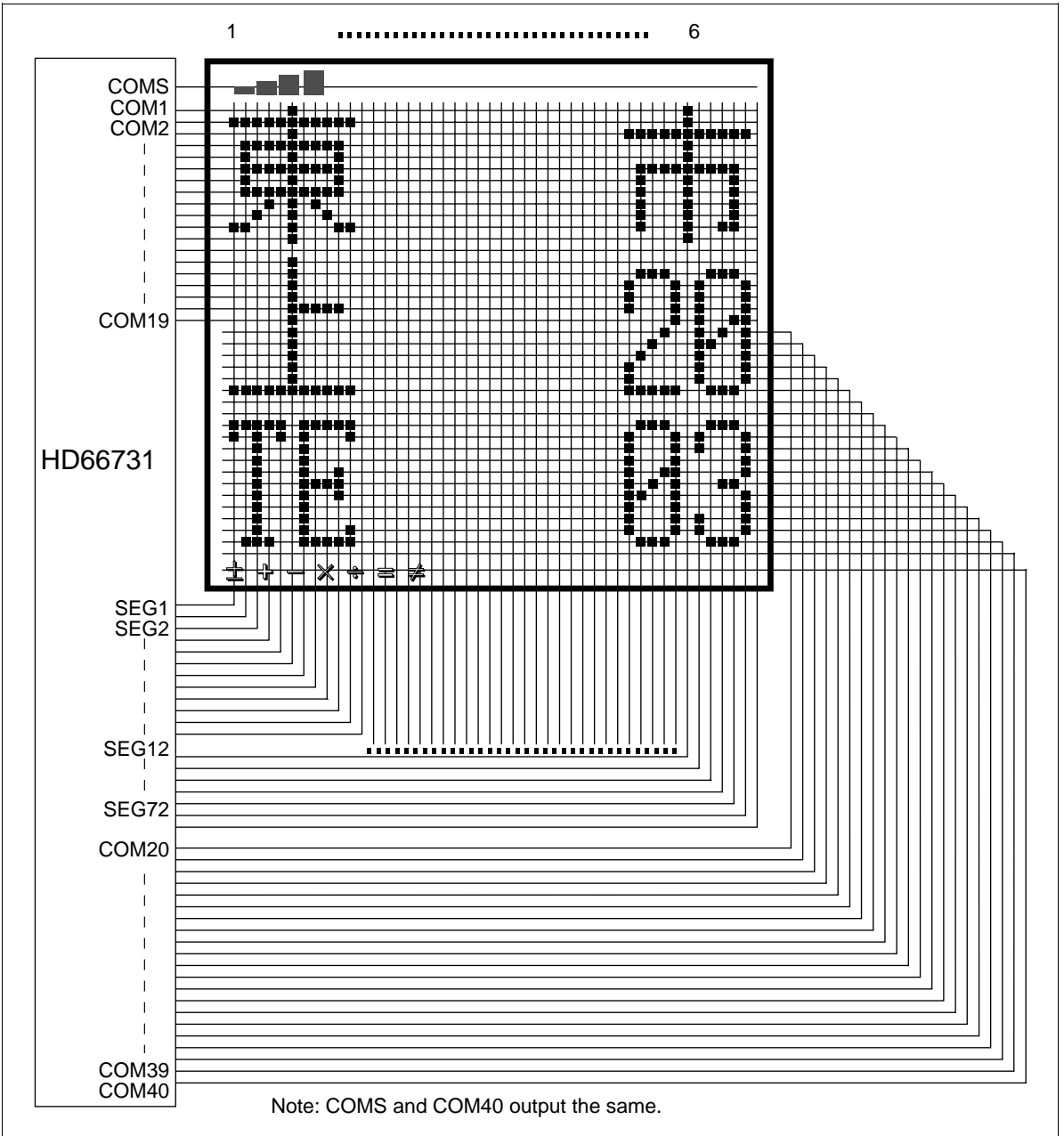
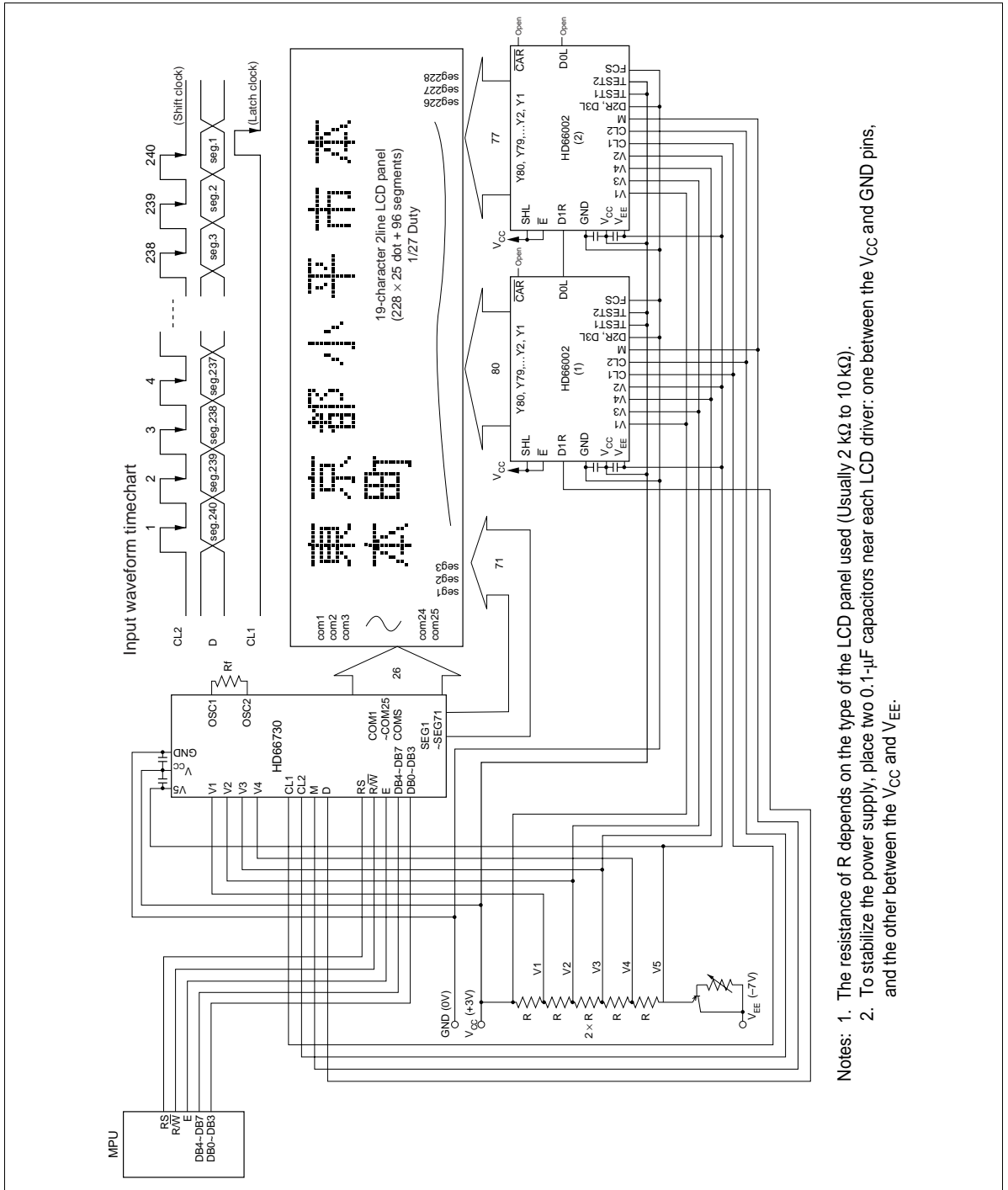

Figure 39 Example of 3-Line/6-Character + 72-Segment Display (Using 1/40 Duty)

Interfacing between HD66730 and HD66002



- Notes:
1. The resistance of R depends on the type of the LCD panel used (Usually 2 kΩ to 10 kΩ).
 2. To stabilize the power supply, place two 0.1-μF capacitors near each LCD driver: one between the V_{CC} and GND pins, and the other between the V_{EE} and V_{CC}.

Figure 40 Example of Display Extension Circuit

Oscillator

Figure 41 shows the optimal value of the oscillation frequency or the external clock frequency depends on the duty drive ratio setting (DT1/0), number of display lines (NL1/0), and the number of display characters (NC1/0) in the HD66730/1. The oscillation frequency or the external clock frequency must be adjusted according to the frame frequency of the liquid crystal drive.

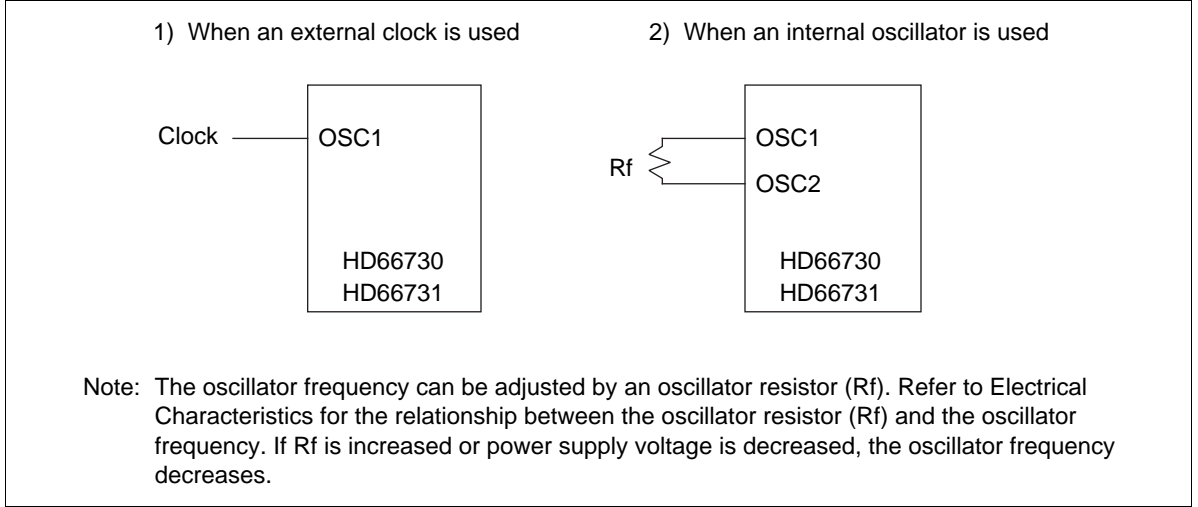

Figure 41 Oscillator Connections

Relationship between the Oscillation Frequency and the Liquid Crystal Display Frame Frequency

Figures 42 to 45 and Tables 24 to 27 show the oscillation frequency and the external clock frequency for various register settings when the frame frequency is 80 Hz.

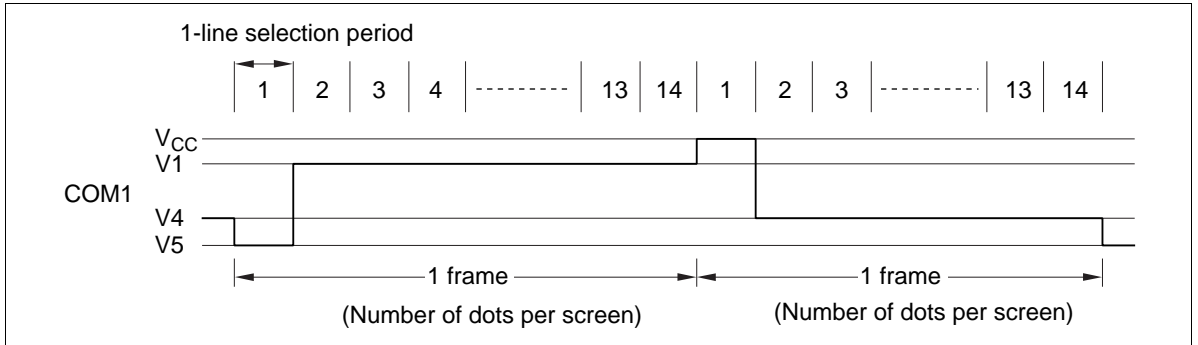

Figure 42 Frame Frequency (1/14 Duty Cycle)

Table 24 1/14 Duty Drive

Number of Display Lines: (NL1/0 Set Value):	1-Line Display (00)		
Number of display characters	6 characters	20 characters	40 characters
(NC1/0 set value)	(00)	(01)	(11)
1-line selection period (dot)	72 dots	240 dots	480 dots
Number of dots per screen (dot)	1008 dots	3360 dots	6720 dots
Oscillation frequency (kHz)*	70	235	475

Number of Display Lines: (NL1/0 Set Value):	2-line Display (01)		
Number of display characters	6 characters	20 characters	40 characters
(NC1/0 set value)	(00)	(01)	(11)
1-line selection period (dot)	72 dots	120 dots	240 dots
Number of dots per screen (dot)	1008 dots	1680 dots	3360 dots
Oscillation frequency (kHz)*	70	120	235

Number of Display Lines: (NL1/0 Set Value):	4-Line Display (11)	
Number of display characters	6 characters	10 characters
(NC1/0 set value)	(00)	(01)
1-line selection period (dot)	72 dots	120 dots
Number of dots per screen (dot)	1008 dots	1680 dots
Oscillation frequency (kHz)*	70	120

Note: * The frequencies in Table 23 are examples when the frame frequency is set to 70 Hz. Adjust the oscillation frequency so that a optimum frame frequency can be obtained.

1/27 Duty Cycle (DT1/0 = 01: 2-Line Drive)

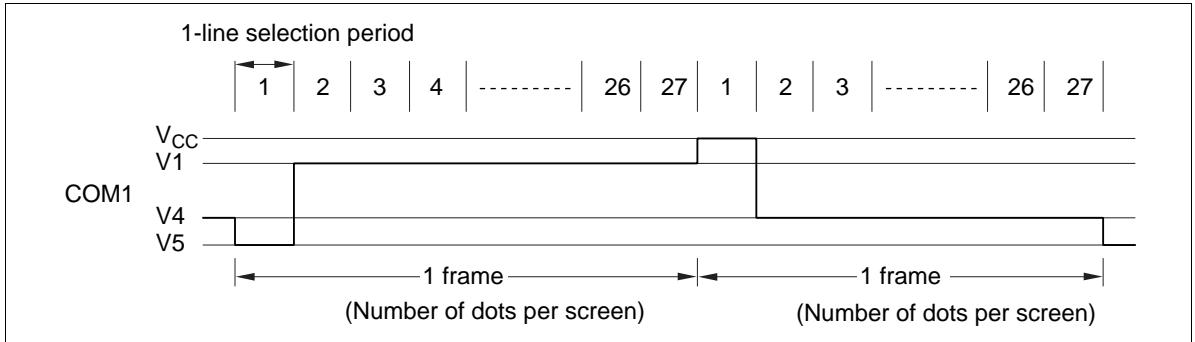

Figure 43 Frame Frequency (1/27 Duty Cycle)

Table 25 1/27 Duty Drive

Number of Display Lines: (NL1/0 Set Value):	2-Line Display (01)		
	Number of display characters	6 characters	10 characters
(NC1/0 set value)	(00)	(01)	(11)
1-line selection period (dot)	72 dots	120 dots	240 dots
Number of dots per screen (dot)	1944 dots	3240 dots	6480 dots
Oscillation frequency (kHz)*	135	225	475

Number of Display Lines: (NL1/0 Set Value):	4-Line Display (11)	
	Number of display characters	6 characters
(NC1/0 set value)	(00)	(01)
1-line selection period (dot)	72 dots	120 dots
Number of dots per screen (dot)	1944 dots	3240 dots
Oscillation frequency (kHz)*	135	225

Note: * The frequencies in Table 24 are examples when the frame frequency is set to 70 Hz. Adjust the oscillation frequency so that an optimum frame frequency can be obtained.

1/40 Duty Cycle (DT1/0 = 10: 3-Line Drive)

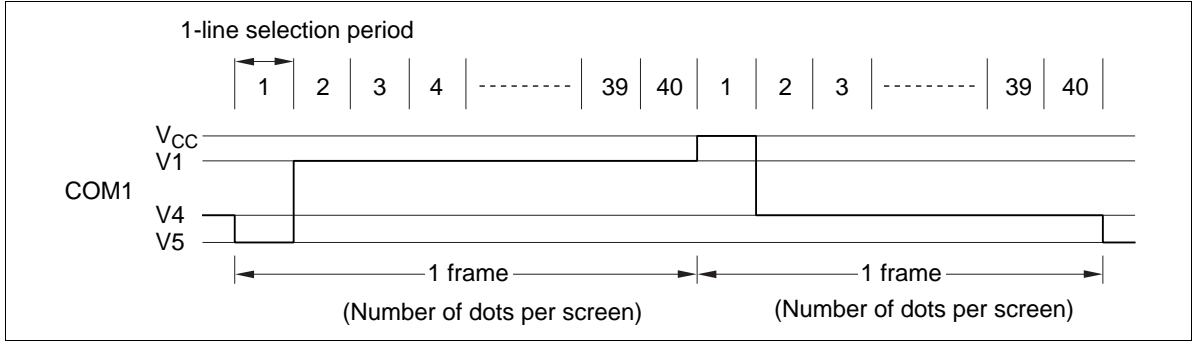

Figure 44 Frame Frequency (1/40 Duty Cycle)

Table 26 1/40 Duty Drive

Number of Display Lines: (NL1/0 set value):	4-Line Display (11)	
Number of display characters	6 characters	10 characters
(NC1/0 set value)	(00)	(01)
1-line selection period (dot)	72 dots	120 dots
Number of dots per screen (dot)	2880 dots	4800 dots
Oscillation frequency (kHz)*	200	335

Note: * The frequencies in Table 25 are examples when the frame frequency is set to 70 Hz. Adjust the oscillation frequency so that an optimum frame frequency can be obtained.

1/53 Duty Cycle (DT1/0 = 11: 4-Line Drive)

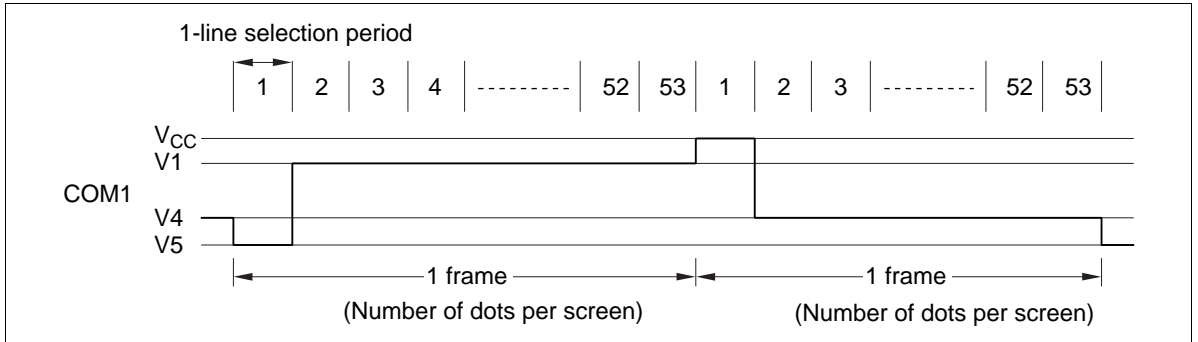

Figure 45 Frame Frequency (1/53 Duty Cycle)

Table 27 1/53 Duty Drive

Number of Display Lines: (NL1/0 Setting Value):	4-line Display (11)	
	(00)	(01)
Number of display characters	6 characters	10 characters
(NC1/0 setting value)	(00)	(01)
1-line selection period (dot)	72 dots	120 dots
Number of dots per screen (dot)	3816 dots	6360 dots
Oscillation frequency (kHz)*	265	445

Note: * The frequencies in Table 26 are examples when the frame frequency is to 80 Hz. Adjust the oscillation frequency so that an optimum frame frequency can be obtained.

Power Supply for Liquid Crystal Display Drive

The HD66730/1 incorporates a booster for raising the LCD voltage two or three times that of the reference voltage input below V_{CC} (Figure 48). A two or three times boosted voltage can be obtained by externally attaching two or three 1- μ F capacitors.

If the LCD panel is large and needs a large amount of drive current, the values of bleeder resistors that generate the V1 to V5 potential are made smaller. However, the load current in the booster and the voltage drop increases in this case.

We recommend setting the resistance value of each bleeder larger than 4.7 k Ω and to hold down the DC load current to 0.4 mA if using a booster circuit. An external power supply should supply LCD voltage if the DC load current exceeds 0.7 mA (Figure 49). Refer to Electrical Characteristics showing the relationship between the load current and booster voltage output. Table 27 shows the duty factor and bleeder resistor value for power supply for liquid crystal display drive.

Table 28 Duty Factor and Bleeder Resistor Value for Power Supply for Liquid Crystal Display Drive

Item	Data				
	1	2	3	4	5
Drive lines (DT1/0 setting value)	1	2	3	4	5
Duty factor	1/14	1/27	1/40	1/53	1/66
Bias	1/4.7	1/6.2	1/7.3	1/8.3	1/9.3
Bleeder resistance value	R1	R	R	R	R
	R0	R*0.7	R*2.2	R*3.3	R*4.3

Note: * R changes depending on the size of a liquid crystal panel. Normally, R must be 4.7 k Ω to 20 k Ω . Adjust R to the optimum value with the consumption current and display picture quality.

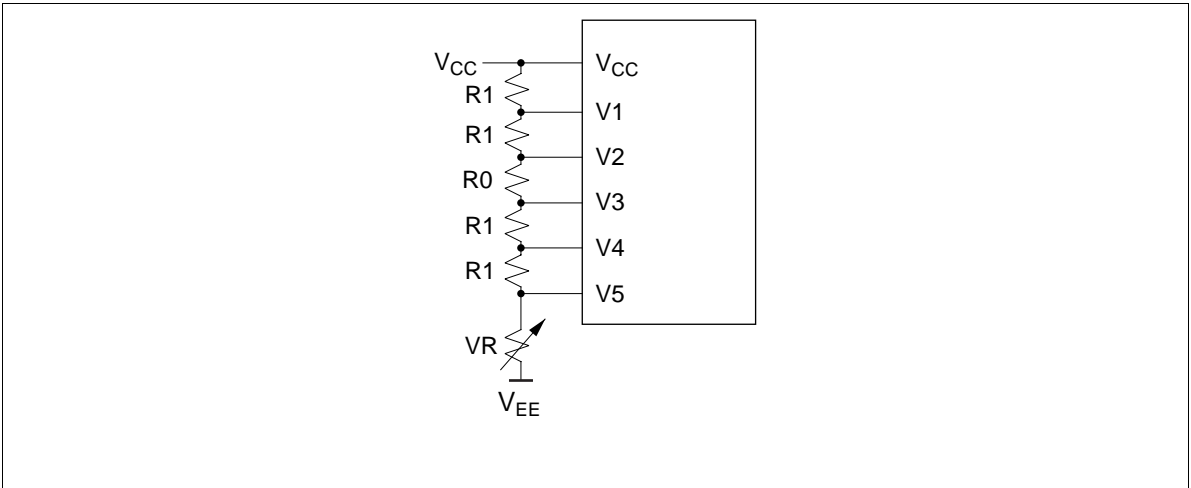
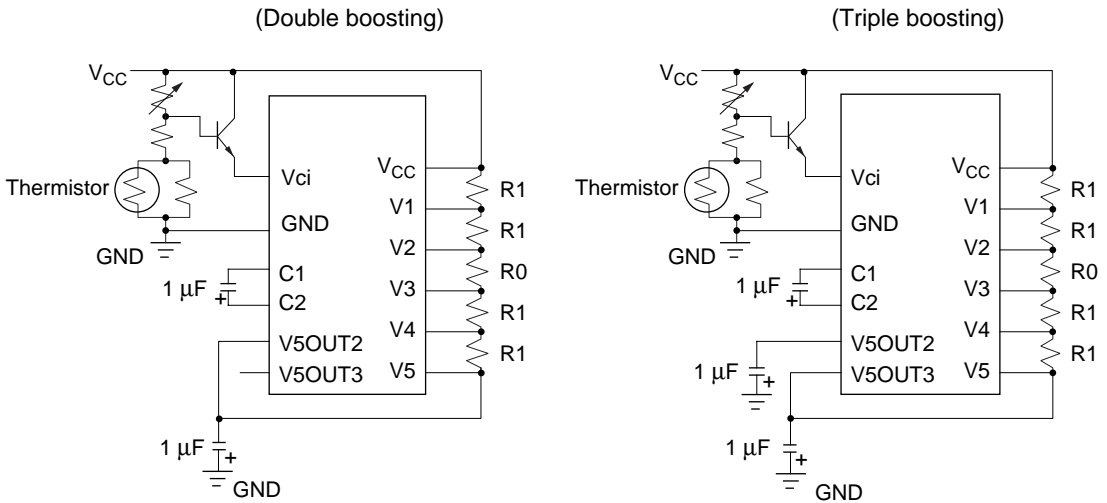

Figure 46 Example of Power Supply for Liquid Crystal Display Drive (with External Power Supply)



- Notes:
1. The reference voltage input (Vci) must be set below the power supply (Vcc).
 2. Current that flows into reference voltage input (Vci) is 2-3 times larger than the load current flowing through bleeder resistors. Note that a reference voltage drop occurs due to the current flowing into the Vci input when a reference voltage (Vci) is generated by resistor division.
 3. The amount of output voltage (V5OUT2/V5OUT3) drop of a booster circuit also increases as the load current flowing through bleeder resistors increases. Thus, set the bleeder resistance as large as possible (4.7 kΩ or greater) without affecting display picture quality.
 4. Adjust the reference voltage input (Vci) according to the fluctuation of booster characteristics because the output voltage (V5OUT2/V5OUT3) drop depends on the load current, operation temperature, operation frequency, capacitance of external capacitors, and manufacturing tolerance. Refer to Electrical Characteristics for details.
 5. Adjust the reference voltage input (Vci) so that the output voltage (V5OUT2/V5OUT3) after boosting will not exceed the absolute maximum rating of liquid crystal power supply voltage (15V).
 6. Make sure that you connect polarized capacitors correctly.

Figure 47 Example of Power Supply for Liquid Crystal Display Drive (with Internal Booster)

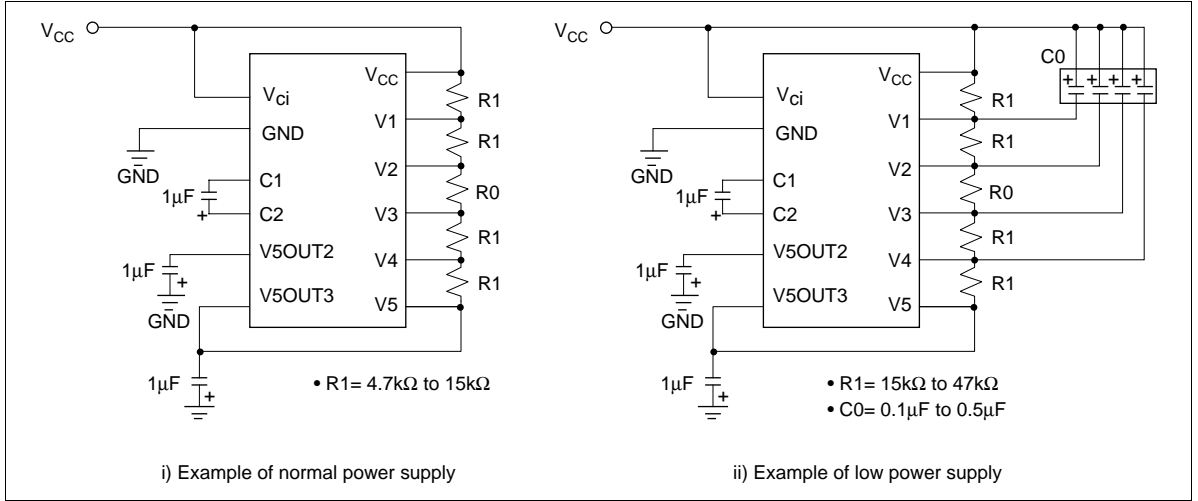

Figure 48 Example of Power Supply for Low Power Consumption

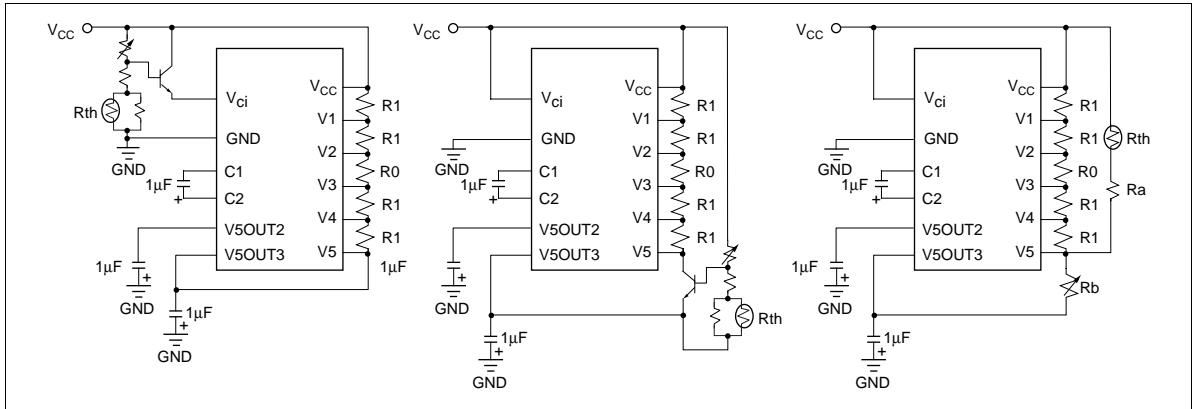

Figure 49 Example of Temperature Compensation Circuit

Absolute Maximum Ratings (HD66730)*

Item	Symbol	Value	Unit	Notes
Power supply voltage (1)	V_{CC}	-0.3 to +7.0	V	1
Power supply voltage (2)	$V_{CC}-V_5$	-0.3 to +17.0	V	1, 2
Input voltage	V_t	-0.3 to $V_{CC} + 0.3$	V	1
Operating temperature	T_{opr}	-30 to +75	°C	
Storage temperature	T_{stg}	-55 to +125	°C	4

Note: * If the LSI is used above these absolute maximum ratings, it may become permanently damaged. Using the LSI within the following electrical characteristic limits is strongly recommended for normal operation. If these electrical characteristic conditions are also exceeded, the LSI will malfunction and cause poor reliability.

Absolute Maximum Ratings (HD66731)*

Item	Symbol	Value	Unit	Notes
Power supply voltage (1)	V_{CC}	-0.3 to +7.0	V	1
Power supply voltage (2)	$V_{CC}-V_5$	-0.3 to +17.0	V	1, 2
Input voltage	V_t	-0.3 to $V_{CC} + 0.3$	V	1
Operating temperature	T_{opr}	-40 to +85	°C	
Storage temperature	T_{stg}	-55 to +110	°C	4

Note: * If the LSI is used above these absolute maximum ratings, it may become permanently damaged. Using the LSI within the following electrical characteristic limits is strongly recommended for normal operation. If these electrical characteristic conditions are also exceeded, the LSI will malfunction and cause poor reliability.

DC Characteristics ($V_{CC} = 2.4\text{ V to }5.5\text{ V}$, $T_a = -30\text{ to }+75^\circ\text{C}^{*3}$)

Item	Symbol	Min	Typ	Max	Unit	Test Condition	Notes
Input high voltage (1) (except OSC1)	VIH1	$0.7V_{CC}$	—	V_{CC}	V		5, 6
Input low voltage (1) (except OSC1)	VIL1	-0.3	—	$0.2V_{CC}$	V	$V_{CC} = 2.4\text{ to }3.0\text{V}$	5, 6
		-0.3	—	0.6	V	$V_{CC} = 3.0\text{ to }4.5\text{V}$	
Input high voltage (2) (OSC1)	VIH2	$0.7V_{CC}$	—	V_{CC}	V		15
Input low voltage (2) (OSC1)	VIL2	—	—	$0.2V_{CC}$	V		15
Output high voltage (1) (D0–D7)	VOH1	$0.75V_{CC}$	—	—	V	$-I_{OH} = 0.1\text{ mA}$	7
Output low voltage (1) (D0–D7)	VOL1	—	—	$0.2V_{CC}$	V	$I_{OL} = 0.1\text{ mA}$	7
Output high voltage (2) (except D0–D7)	VOH2	$0.8V_{CC}$	—	—	V	$-I_{OH} = 0.04\text{ mA}$	8
Output low voltage (2) (except D0–D7)	VOL2	—	—	$0.2V_{CC}$	V	$I_{OL} = 0.04\text{ mA}$	8
Driver ON resistance (COM)	R_{COM}	—	2	20	$k\Omega$	$\pm I_d = 0.05\text{ mA}$, VLCD = 4V	13
Driver ON resistance (SEG)	R_{SEG}	—	2	30	$k\Omega$	$\pm I_d = 0.05\text{ mA}$, VLCD = 4V	13
I/O leakage current	I_{LI}	-1	—	1	μA	$V_{IN} = 0\text{ to }V_{CC}$	9
Pull-up MOS current (RESET* pin)	$-I_p$	5	50	120	μA	$V_{CC} = 3\text{V}$ $V_{IN} = 0\text{V}$	
Power supply current	I_{CC1}	—	150	300	μA	R_f oscillation, external clock $V_{CC} = 3\text{V}$, $f_{OSC} = 215\text{ kHz}$	10, 14
	I_{CC2}	—	25	—	μA	Sleep mode $V_{CC} = 3\text{V}$ $f_{OSC} = 215\text{ kHz}$	
LCD voltage	VLCD	3.0	—	15.0	V	$V_{CC}-V_5$	16

Booster Characteristics

Item	Symbol	Min	Typ	Max	Unit	Test Condition	Notes*
Output voltage (V5OUT2 pin)	VUP2	8.2	8.9	—	V	$V_{CC} = V_{Ci} = 4.5V$, $I_o = 0.25\text{ mA}$, $C = 1\ \mu\text{F}$, $f_{OSC} = 215\text{ kHz}$, $T_a = 25^\circ\text{C}$	18
Output voltage (V5OUT3 pin)	VUP3	7.2	7.8	—	V	$V_{CC} = V_{Ci} = 2.7V$, $I_o = 0.25\text{ mA}$, $C = 1\ \mu\text{F}$, $f_{OSC} = 215\text{ kHz}$, $T_a = 25^\circ\text{C}$	18
Input voltage	V _{Ci}	1.0	—	5.0	V	$V_{Ci} \leq V_{CC}$	18, 19

AC Characteristics ($V_{CC} = 2.4V$ to $5.5V$, $T_a = -30$ to $+75^\circ\text{C}^{*3}$)
Clock Characteristics ($V_{CC} = 2.7\text{ V}$ to 5.5 V , $T_a = -30$ to $+75^\circ\text{C}^{*3}$)

Item		Symbol	Min	Typ	Max	Unit	Test Condition	Notes*
External clock operation	External clock frequency	f_{cp}	80	215	350	kHz	$V_{CC} = 2.4$ to $2.7V$	11
			80	215	550		$V_{CC} = 2.7$ to $5.5V$	
	External clock duty	Duty	45	50	55	%		
	External clock rise time	t_{rtp}	—	—	0.2	μs		
	External clock fall time	t_{rtp}	—	—	0.2	μs		
R_i oscillation	Clock oscillation frequency (HD66730)	f_{OSC}	110	150	200	kHz	$R_i = 150\text{ k}\Omega$, $V_{CC} = 3V$	12
	Clock oscillation frequency (HD66731)	f_{OSC}	150	215	275		$R_i = 91\text{ k}\Omega$, $V_{CC} = 3V$	

**System Interface Timing Characteristics (1) ($V_{CC} = 2.4V$ to $4.5V$,
 $T_a = -30$ to $+75^{\circ}C^{*3}$)**

Bus Write Operation

Item	Symbol	Min	Typ	Max	Unit	Test Condition
Enable cycle time	t_{CYCE}	500	—	—	ns	Figure 50
Enable pulse width (high level)	PW_{EH}	250	—	—		$V_{CC} = 2.4$ to $3.0V$
		150	—	—		$V_{CC} = 3.0$ to $4.5V$
Enable rise/fall time	t_{Er}, t_{Ef}	—	—	20		Figure 50
Address set-up time (RS, R/W to E)	t_{AS}	80	—	—		
Address hold time	t_{AH}	20	—	—		
Data set-up time	t_{DSW}	140	—	—		
Data hold time	t_H	30	—	—		

Bus Read Operation

Item	Symbol	Min	Typ	Max	Unit	Test Condition
Enable cycle time	t_{CYCE}	1000	—	—	ns	Figure 51
Enable pulse width (high level)	PW_{EH}	450	—	—		
Enable rise/fall time	t_{Er}, t_{Ef}	—	—	25		
Address set-up time (RS, R/W to E)	t_{AS}	60	—	—		
Address hold time	t_{AH}	20	—	—		
Data delay time	t_{DDR}	—	—	360		
Data hold time	t_{DHR}	5	—	—		

Serial Interface Operation

Item	Symbol	Min	Typ	Max	Unit	Test Condition
Serial clock cycle time	t_{SCYC}	1	—	20	μs	Figure 52
Serial clock (high level width)	t_{SCH}	400	—	—	ns	
Serial clock (low level width)	t_{SCL}	400	—	—		
Serial clock rise/fall time	t_{scr}, t_{scf}	—	—	50		
Chip select set-up time	t_{CSU}	60	—	—		
Chip select hold time	t_{CH}	200	—	—		
Serial input data set-up time	t_{SISU}	200	—	—		
Serial input data hold time	t_{SIH}	200	—	—		
Serial output data delay time	t_{SOD}	—	—	360		
Serial output data hold time	t_{SOH}	5	—	—		

**System Interface Timing Characteristics (2) ($V_{CC} = 4.5V$ to $5.5V$,
 $T_a = -30$ to $+75^{\circ}C^{*3}$)**

Bus Write Operation

Item	Symbol	Min	Typ	Max	Unit	Test Condition
Enable cycle time	t_{CYCE}	500	—	—	ns	Figure 50
Enable pulse width (high level)	PW_{EH}	150	—	—		
Enable rise/fall time	t_{Er}, t_{Ef}	—	—	20		
Address set-up time (RS, R/W to E)	t_{AS}	40	—	—		
Address hold time	t_{AH}	30	—	—		
Data set-up time	t_{DSW}	80	—	—		
Data hold time	t_H	30	—	—		

Bus Read Operation

Item	Symbol	Min	Typ	Max	Unit	Test Condition
Enable cycle time	t_{CYCE}	500	—	—	ns	Figure 51
Enable pulse width (high level)	PW_{EH}	230	—	—		
Enable rise/fall time	t_{Er}, t_{Ef}	—	—	20		
Address set-up time (RS, R/W to E)	t_{AS}	40	—	—		
Address hold time	t_{AH}	30	—	—		
Data delay time	t_{DDR}	—	—	160		
Data hold time	t_{DHR}	5	—	—		

Serial Interface Sequence

Item	Symbol	Min	Typ	Max	Unit	Test Condition
Serial clock cycle time	t_{SCYC}	0.5	—	20	μs	Figure 52
Serial clock (high level width)	t_{SCH}	200	—	—	ns	
Serial clock (low level width)	t_{SCL}	200	—	—		
Serial clock rise/fall time	t_{scr}, t_{scf}	—	—	50		
Chip select set-up time	t_{CSU}	60	—	—		
Chip select hold time	t_{CH}	100	—	—		
Serial input data set-up time	t_{SISU}	100	—	—		
Serial input data hold time	t_{SIH}	100	—	—		
Serial output data delay time	t_{SOD}	—	—	160		
Serial output data hold time	t_{SOH}	5	—	—		

HD66730 Segment Extension Signal Timing Characteristics ($V_{CC} = 2.4V$ to $5.5V$, $T_a = -30$ to $+75^{\circ}C^{*3}$)

Item		Symbol	Min	Typ	Max	Unit	Test Condition
Clock pulse width	High level	t_{CWH}	800	—	—	ns	Figure 53
	Low level	t_{CWL}	800	—	—		
Clock set-up time		t_{CSU}	500	—	—		
Data set-up time		t_{SU}	300	—	—		
Data hold time		t_{DH}	300	—	—		
M delay time		t_{DM}	-1000	—	1000		
COMD set-up time		t_{DSU}	300				
Clock rise/fall time	COMD	t_{ct1}	—	—	700		
	Pins except COMD	t_{ct2}	—	—	200		

Reset Timing Characteristics ($V_{CC} = 2.4V$ to $5.5V$, $T_a = -30$ to $+75^{\circ}C^{*3}$)

Item		Symbol	Min	Typ	Max	Unit	Test Condition
Reset low-level width		t_{RES}	10	—	—	ms	Figure 54

Electrical Characteristics Notes

1. All voltage values are referred to GND = 0V. If the LSI is used above the absolute maximum ratings, it may become permanently damaged. Using the LSI within the electrical characteristic is strongly recommended to ensure normal operation. If these electrical characteristic are exceeded, the LSI may malfunction or exhibit poor reliability.
2. $V_{CC} \geq V_5$ must be maintained. When the COM25/COMD pin is used as a extension driver interface signal (COMD), $GND \geq V_5$ must be maintained.
3. For die products, specified at 75°C.
4. For die products, specified by the die shipment specification.
5. The following four circuits are I/O pin configurations except for liquid crystal display output.

Input pin
Pin: E/SCLK, RS/CS*, RW/SID, IM,

Input pin
Pins: RESET*

Output pin
Pins: CL1, CL2, M, SEGD (HD66730)
TESTD (HD66731)

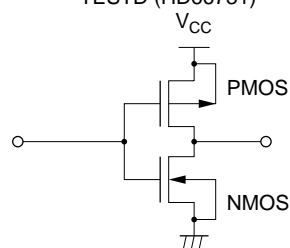
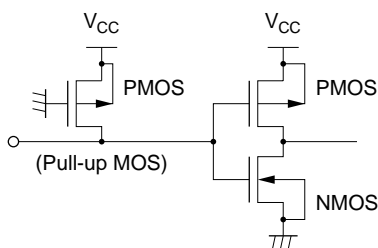
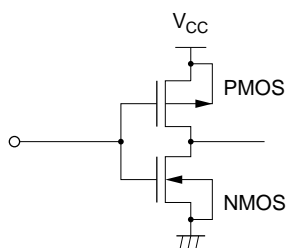

I/O Pin
Pins: DB0/SOD to DB7

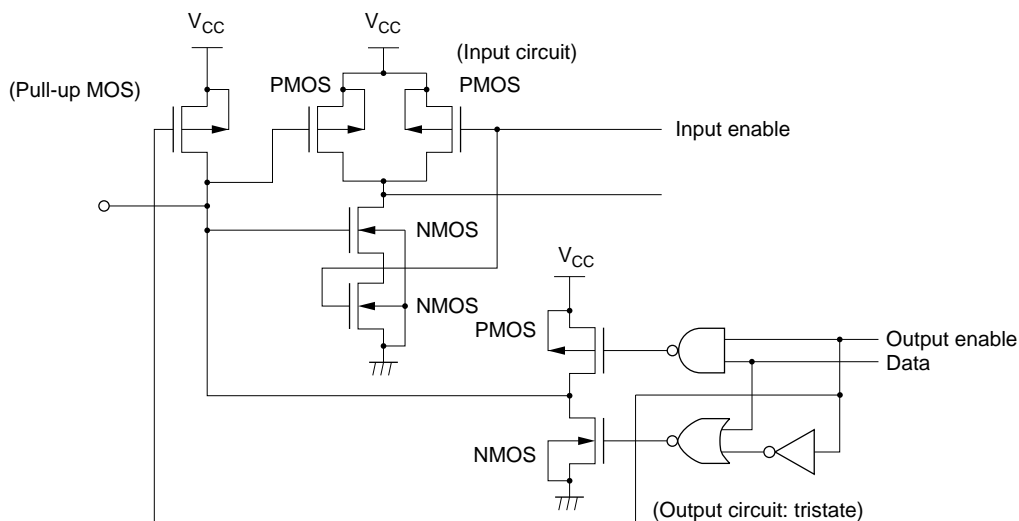

6. Applies to input pins and I/O pins, excluding the OSC1 pin.
7. Applies to I/O pins.
8. Applies to output pins of HD66730.
9. Current flowing through pull-up MOSs, excluding output drive MOSs.

- 10. Input/output current is excluded. When input is at an intermediate level with CMOS, the excessive current flows through the input circuit to the power supply. To avoid this from happening, the input level must be fixed high or low.
- 11. Applies only to external clock operation.

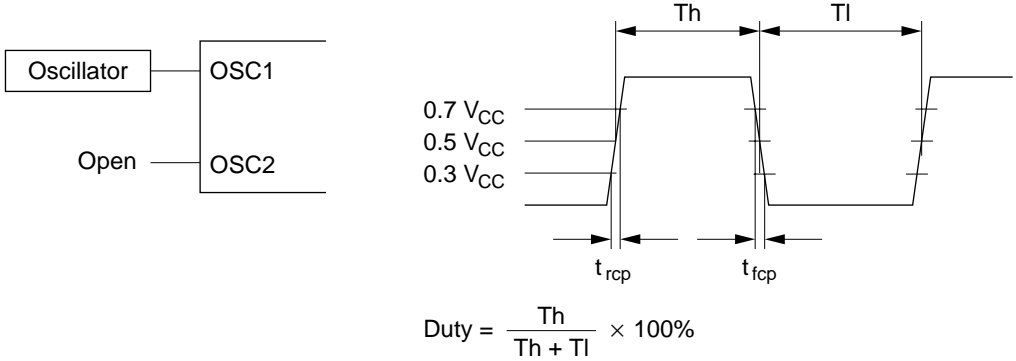

- 12. Applies only to the internal oscillator operation using oscillation resistor R_f .

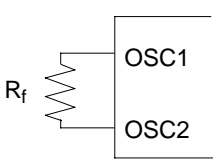

Recommended resistor value

R_f : $150\text{k}\Omega \pm 2\%$ (When $V_{CC} = 3\text{V}$ to 4V)

R_f : $180\text{k}\Omega \pm 2\%$ (When $V_{CC} = 4\text{V}$ to 5V)

Since oscillation frequency varies depending on OSC1 and OSC2 terminal capacitance, wiring length to these pins should be minimized.

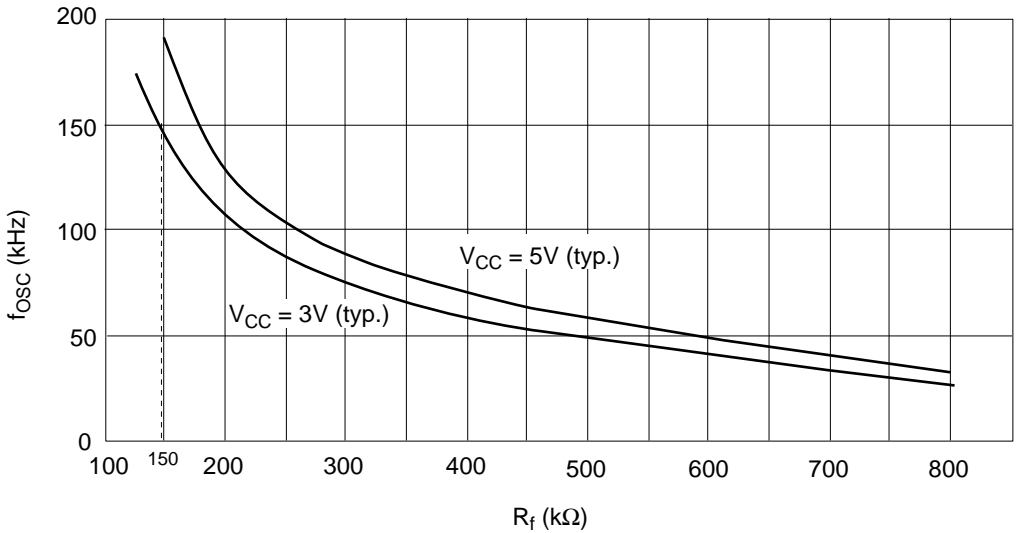

13. RCOM is the resistance between the power supply pins (V_{CC} , V1, V4, V5) and each common signal pin (COM0 to COM25/COM53).

RSEG is the resistance between the power supply pins (V_{CC} , V2, V3, V5) and each segment signal pin (SEG1 to SEG71/SEG119).

14. The following graphs show the relationship between operation frequency and current consumption (referential data).

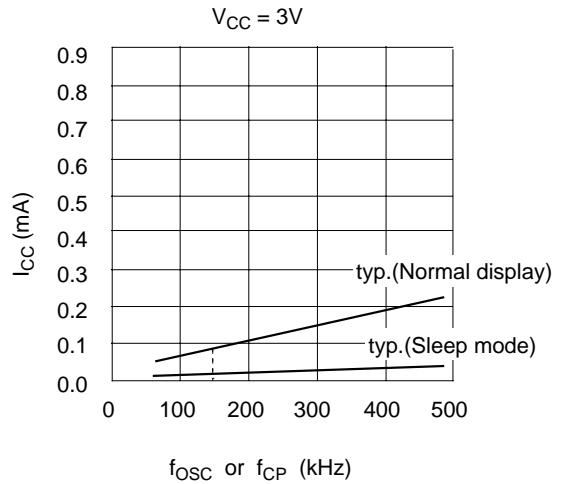
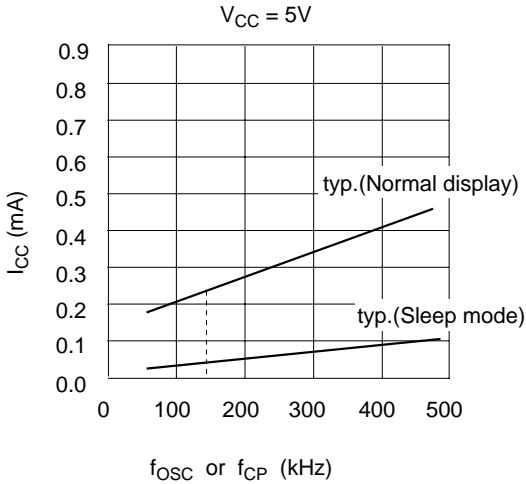

15. Applies to the OSC1 pin.

16. Each COM and SEG output voltage is within $\pm 0.15V$ of the LCD voltage (V_{CC} , V1, V2, V3, V4, V5) when there is no load.

17. The TEST pin must be fixed to ground, and the IM pin must also be connected to V_{CC} or ground.

18. Booster characteristics test circuits are shown below.

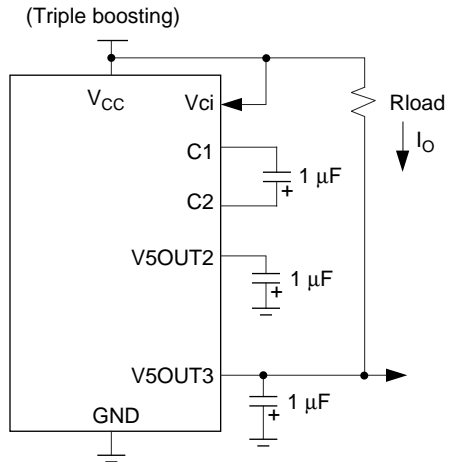
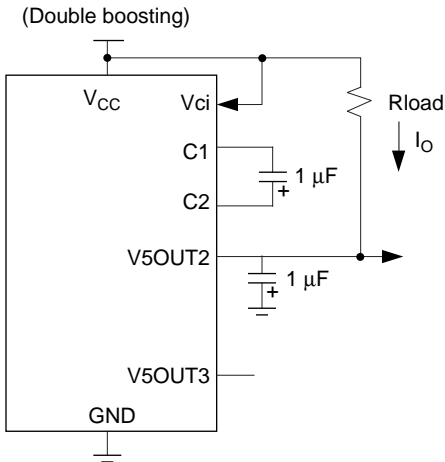

$VUP2 = V_{CC} - V5OUT2$ $VUP3 = V_{CC} - V5OUT3$

(i) $VUP2, VUP3$ vs V_{ci}

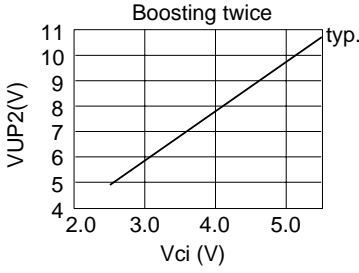

Test condition : $V_{ci} = V_{CC}$, $f_{cp} = 140kHz$, $T_a = 25^\circ C$

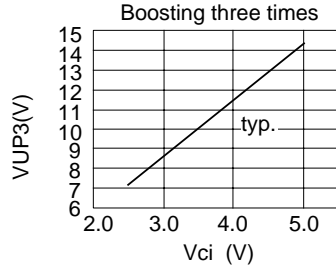

Test condition : $V_{ci} = V_{CC}$, $f_{cp} = 140kHz$, $T_a = 25^\circ C$

(ii) $VUP2, VUP3$ vs T_a

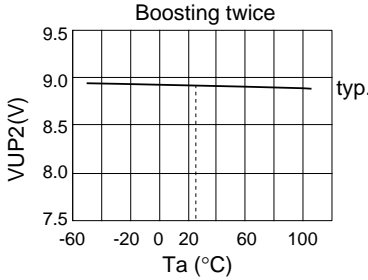

Test condition : $V_{ci} = V_{CC} = 4.5V$, $R_f = 180k\Omega$, $I_o = 0.1mA$

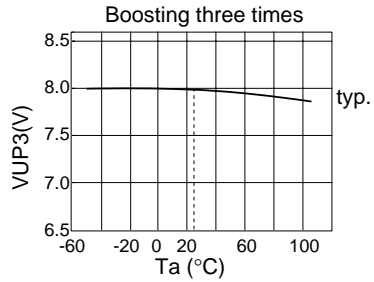

Test condition : $V_{ci} = V_{CC} = 2.7V$, $R_f = 150k\Omega$, $I_o = 0.1mA$

(iii) $VUP2, VUP3$ vs Capacitance

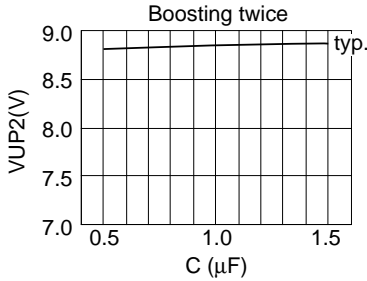

Test condition : $V_{ci} = V_{CC} = 4.5V$, $R_f = 180k\Omega$, $I_o = 0.1mA$

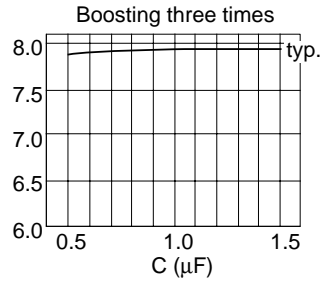

Test condition : $V_{ci} = V_{CC} = 2.7V$, $R_f = 150k\Omega$, $I_o = 0.1mA$

(iv) $VUP2, VUP3$ vs I_o

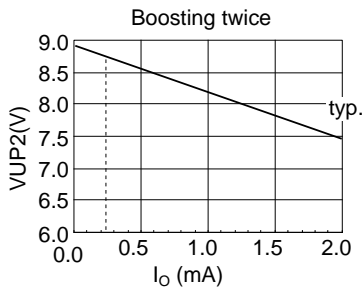

Test condition : $V_{ci} = V_{CC} = 4.5V$, $R_f = 180k\Omega$, $T_a = 25^\circ C$

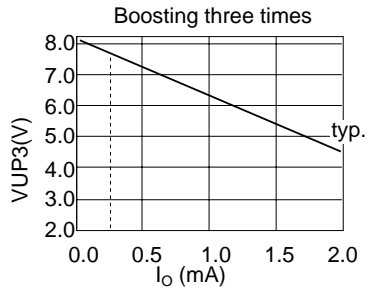

Test condition : $V_{ci} = V_{CC} = 2.7V$, $R_f = 150k\Omega$, $T_a = 25^\circ C$

19. $V_{ci} \leq V_{CC}$ must be maintained.

Load Circuits

AC Characteristics Test Load Circuits

Data bus: DB0 to DB7, SOD

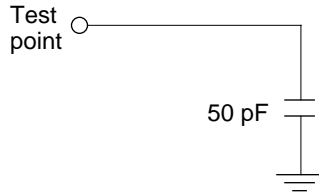

Segment extension signals: CL1, CL2, SEGD, M, COMD

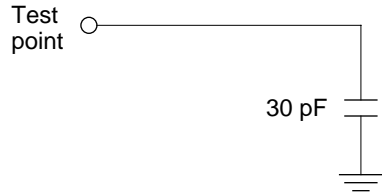

Timing Characteristics

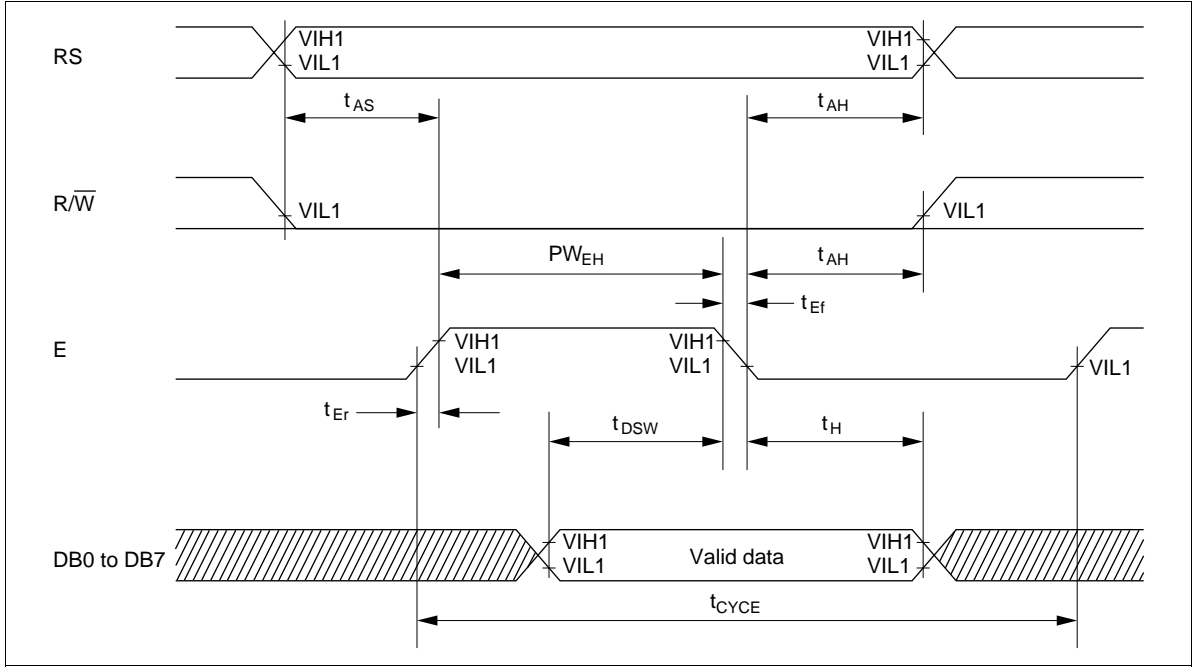

Figure 50 Bus Write Operation

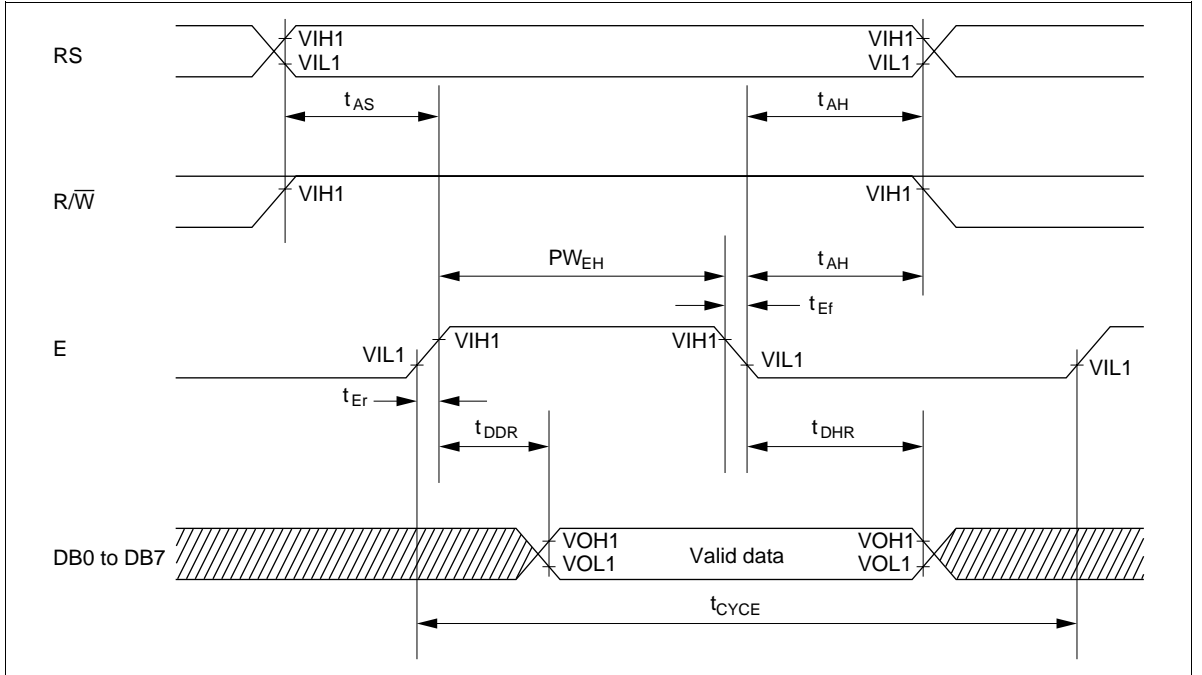

Figure 51 Bus Read Operation

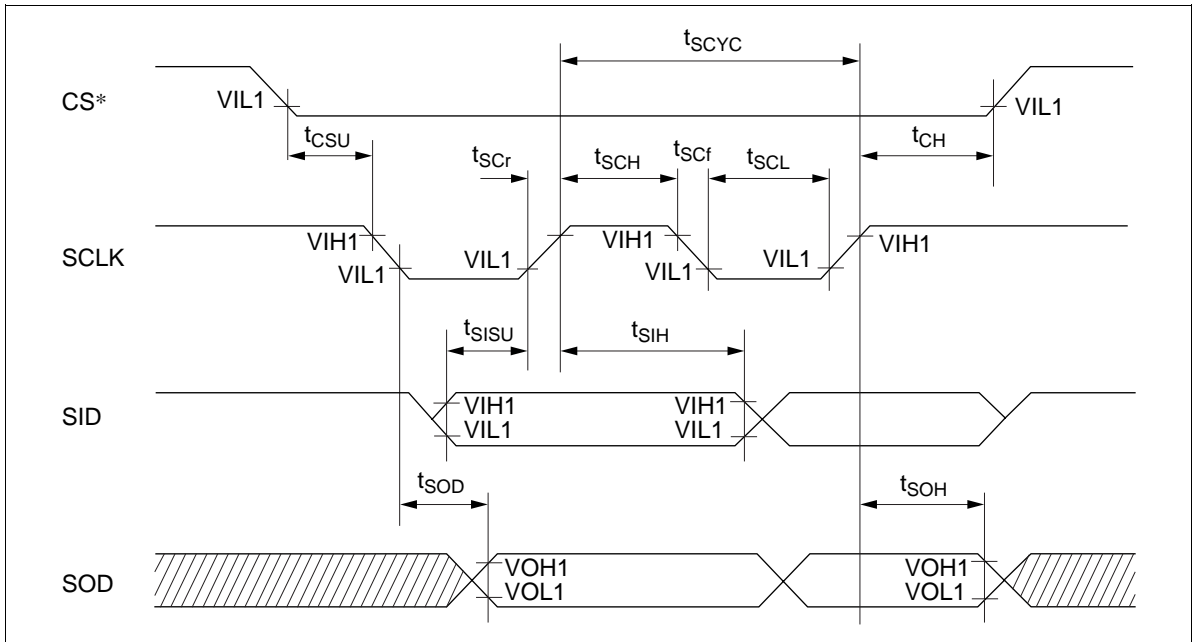

Figure 52 Serial Interface Timing

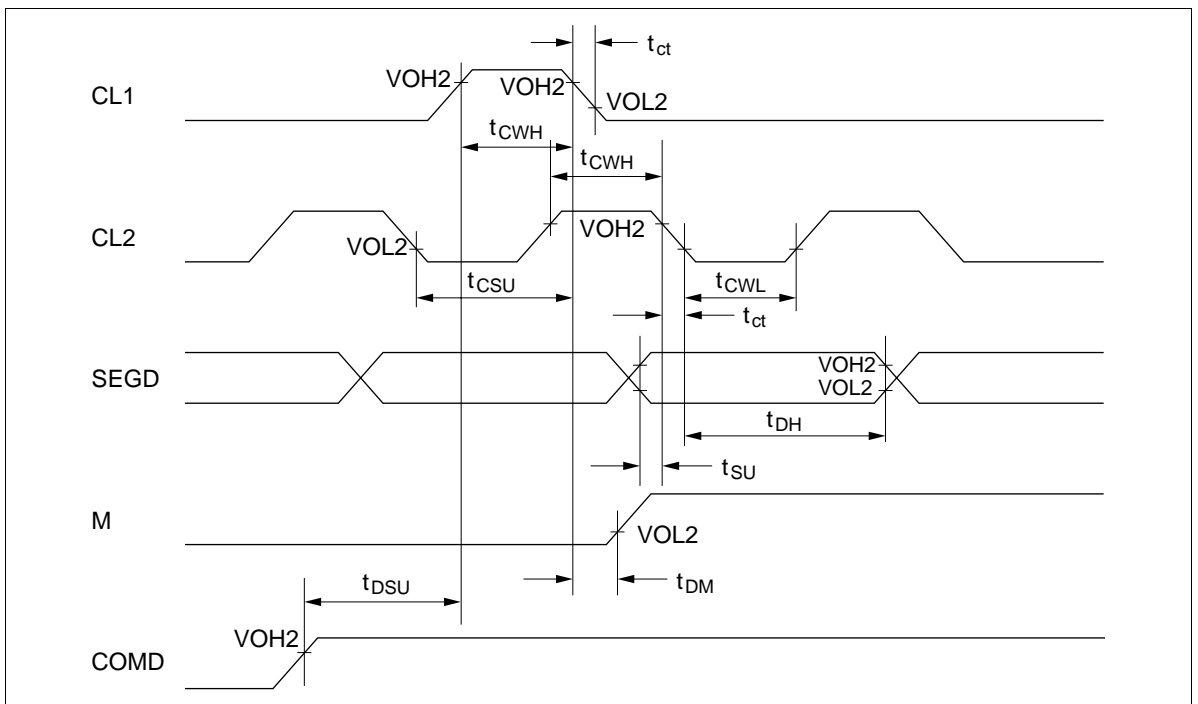

Figure 53 Interface Timing with Extension Driver

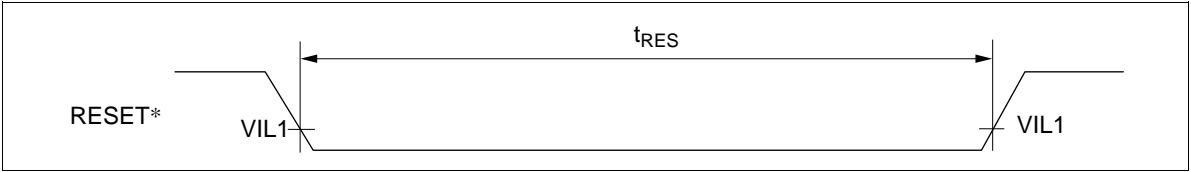

Figure 54 Reset Timing

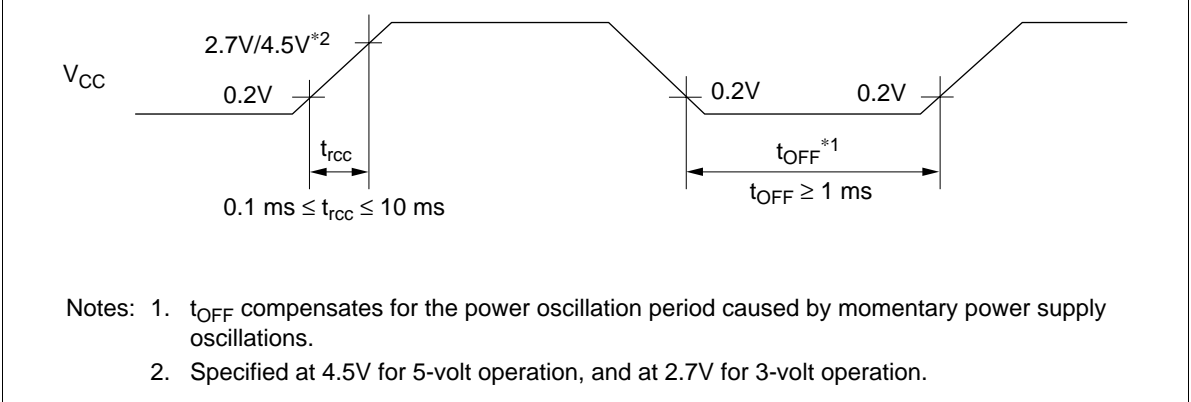

Figure 55 Power Supply Sequence

Cautions

1. Hitachi neither warrants nor grants licenses of any rights of Hitachi's or any third party's patent, copyright, trademark, or other intellectual property rights for information contained in this document. Hitachi bears no responsibility for problems that may arise with third party's rights, including intellectual property rights, in connection with use of the information contained in this document.
2. Products and product specifications may be subject to change without notice. Confirm that you have received the latest product standards or specifications before final design, purchase or use.
3. Hitachi makes every attempt to ensure that its products are of high quality and reliability. However, contact Hitachi's sales office before using the product in an application that demands especially high quality and reliability or where its failure or malfunction may directly threaten human life or cause risk of bodily injury, such as aerospace, aeronautics, nuclear power, combustion control, transportation, traffic, safety equipment or medical equipment for life support.
4. Design your application so that the product is used within the ranges guaranteed by Hitachi particularly for maximum rating, operating supply voltage range, heat radiation characteristics, installation conditions and other characteristics. Hitachi bears no responsibility for failure or damage when used beyond the guaranteed ranges. Even within the guaranteed ranges, consider normally foreseeable failure rates or failure modes in semiconductor devices and employ systemic measures such as fail-safes, so that the equipment incorporating Hitachi product does not cause bodily injury, fire or other consequential damage due to operation of the Hitachi product.
5. This product is not designed to be radiation resistant.
6. No one is permitted to reproduce or duplicate, in any form, the whole or part of this document without written approval from Hitachi.
7. Contact Hitachi's sales office for any questions regarding this document or Hitachi semiconductor products.

HITACHI

Hitachi, Ltd.

Semiconductor & Integrated Circuits.
Nippon Bldg., 2-6-2, Ohte-machi, Chiyoda-ku, Tokyo 100-0004, Japan
Tel: Tokyo (03) 3270-2111 Fax: (03) 3270-5109

URL	North America	: http://semiconductor.hitachi.com/
	Europe	: http://www.hitachi-eu.com/hel/ecg
	Asia (Singapore)	: http://www.has.hitachi.com.sg/grp3/sicd/index.htm
	Asia (Taiwan)	: http://www.hitachi.com.tw/E/Product/SICD_Frame.htm
	Asia (HongKong)	: http://www.hitachi.com.hk/eng/bo/grp3/index.htm
	Japan	: http://www.hitachi.co.jp/Sicd/indx.htm

For further information write to:

Hitachi Semiconductor
(America) Inc.
179 East Tasman Drive,
San Jose, CA 95134
Tel: <1> (408) 433-1990
Fax: <1> (408) 433-0223

Hitachi Europe GmbH
Electronic components Group
Dornacher Straße 3
D-85622 Feldkirchen, Munich
Germany
Tel: <49> (89) 9 9180-0
Fax: <49> (89) 9 29 30 00

Hitachi Europe Ltd.
Electronic Components Group.
Whitebrook Park
Lower Cookham Road
Maidenhead
Berkshire SL6 8YA, United Kingdom
Tel: <44> (1628) 585000
Fax: <44> (1628) 778322

Hitachi Asia Pte. Ltd.
16 Collyer Quay #20-00
Hitachi Tower
Singapore 049318
Tel: 535-2100
Fax: 535-1533

Hitachi Asia Ltd.
Taipei Branch Office
3F, Hung Kuo Building, No.167,
Tun-Hwa North Road, Taipei (105)
Tel: <886> (2) 2718-3666
Fax: <886> (2) 2718-8180

Hitachi Asia (Hong Kong) Ltd.
Group III (Electronic Components)
7/F., North Tower, World Finance Centre,
Harbour City, Canton Road, Tsim Sha Tsui,
Kowloon, Hong Kong
Tel: <852> (2) 735 9218
Fax: <852> (2) 730 0281
Telex: 40815 HITEC HX

Copyright © Hitachi, Ltd., 1998. All rights reserved. Printed in Japan.