

DESCRIPTION

The RH37C combines very low noise with excellent precision and high speed specifications. The low $1/f$ noise corner frequency of 2.7Hz combined with $3.5\text{nV}/\sqrt{\text{Hz}}$ 10Hz noise and low offset voltage make the RH37C an excellent choice for low frequency military instrumentation applications. The wafer lots are processed to LTC's in-house Class S flow to yield circuits usable in stringent military applications.

For complete electrical specifications and performance curves see the OP-27/OP-37 data sheet.

ABSOLUTE MAXIMUM RATINGS

Supply Voltage	$\pm 22\text{V}$
Internal Power Dissipation	500mW
Input Voltage	Equal to Supply Voltage
Output Short-Circuit Duration	Indefinite
Differential Input Current (Note 8)	$\pm 25\text{mA}$
Operating Temperature Range	-55°C to 125°C
Junction Temperature Range	-55°C to 150°C
Storage Temperature Range	-65°C to 150°C
Lead Temperature (Soldering, 10 sec)	300°C

 LTC and LT are registered trademarks of Linear Technology Corporation.

BURN-IN CIRCUIT

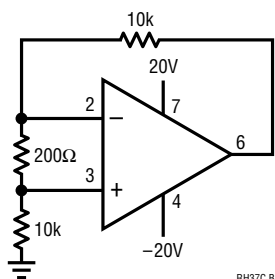

RH37C BI

PACKAGE/ORDER INFORMATION

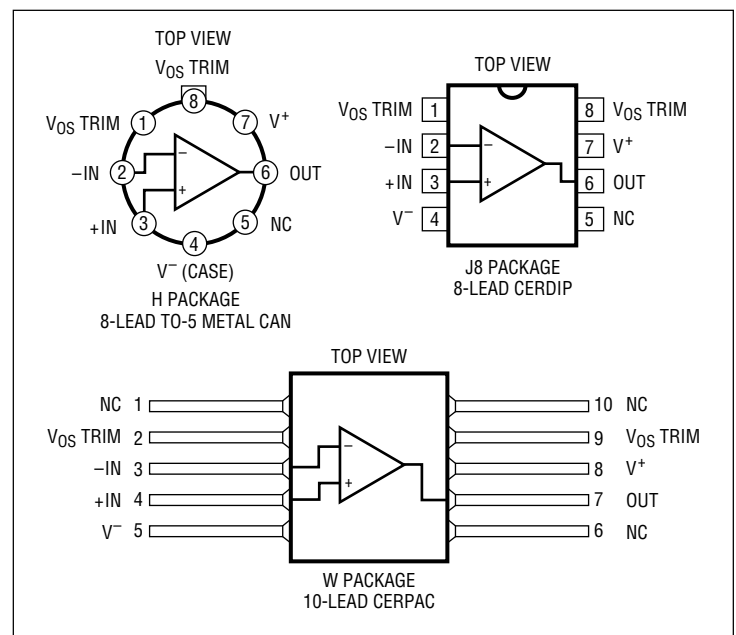

TABLE 1: ELECTRICAL CHARACTERISTICS (Preirradiation) (Note 9)

SYMBOL	PARAMETER	CONDITIONS	NOTES	$T_A = 25^\circ\text{C}$			SUB-GROUP	$-55^\circ\text{C} \leq T_A \leq 125^\circ\text{C}$			SUB-GROUP	UNITS
				MIN	TYP	MAX		MIN	TYP	MAX		
V_{OS}	Input Offset Voltage		1			100	4			300	2, 3	μV
$\frac{\Delta V_{OS}}{\Delta \text{Temp}}$	Average Offset Drift		4, 7							1.8		$\mu\text{V}/^\circ\text{C}$
$\frac{\Delta V_{OS}}{\Delta \text{Time}}$	Long-Term Input Offset Voltage Stability		2, 4			2						$\mu\text{V}/\text{Month}$
I_{OS}	Input Offset Current					75	1			135	2, 3	nA
I_B	Input Bias Current					± 80	1			± 150	2, 3	nA

TABLE 1: ELECTRICAL CHARACTERISTICS (Preirradiation) (Note 9)

SYMBOL	PARAMETER	CONDITIONS	NOTES	$T_A = 25^\circ\text{C}$			SUB-GROUP	$-55^\circ\text{C} \leq T_A \leq 125^\circ\text{C}$			SUB-GROUP	UNITS	
				MIN	TYP	MAX		MIN	TYP	MAX			
e_n	Input Noise Voltage	0.1Hz to 10Hz	4, 5			0.25						$\mu\text{V}_{\text{P-P}}$	
	Input Noise Voltage Density	$f_0 = 10\text{Hz}$	3			8.0						$\text{nV}/\sqrt{\text{Hz}}$	
		$f_0 = 30\text{Hz}$	4			5.6						$\text{nV}/\sqrt{\text{Hz}}$	
		$f_0 = 1000\text{Hz}$	4			4.5						$\text{nV}/\sqrt{\text{Hz}}$	
i_n	Input Noise Current Density	$f_0 = 1000\text{Hz}$	4, 6			0.6						$\text{pV}/\sqrt{\text{Hz}}$	
	Input Resistance Common Mode					2						$\text{G}\Omega$	
	Input Voltage Range		4			± 11			± 10.2			V	
CMRR	Common Mode Rejection Ratio	$V_{\text{CM}} = \pm 11\text{V}$				100			1			dB	
		$V_{\text{CM}} = \pm 10\text{V}$								94		2, 3	dB
PSRR	Power Supply Rejection Ratio	$V_S = \pm 4\text{V}$ to $\pm 18\text{V}$				94			1			dB	
		$V_S = \pm 4.5\text{V}$ to $\pm 18\text{V}$								86		2, 3	dB
A_{VOL}	Large-Signal Voltage Gain	$R_L \geq 2\text{k}$, $V_0 = \pm 10\text{V}$	4			700			4			300	V/mV
		$R_L \geq 600\Omega$, $V_0 = \pm 1\text{V}$				200							V/mV
V_{OUT}	Maximum Output Voltage Swing	$R_L = 2\text{k}$				± 11.5			4			± 10.5	V
		$R_L = 600\Omega$				± 10.0			4				V
SR	Slew Rate	$R_L = 2\text{k}$, $A_{\text{VCL}} \geq 5$				11			7			$\text{V}/\mu\text{s}$	
GBW	Gain-Bandwidth Product	$f_0 = 10\text{kHz}$ ($A_{\text{VCL}} \geq 5$)	4			45							MHz
		$f_0 = 1\text{MHz}$ ($A_{\text{VCL}} \geq 5$)					40						
Z_0	Open-Loop Output Resistance	$V_0 = 0$, $I_0 = 0$				470						Ω	
P_D	Power Dissipation								1			170	mW

TABLE 1A: ELECTRICAL CHARACTERISTICS (Postirradiation) (Note 10)

SYMBOL	PARAMETER	CONDITIONS	NOTES	10KRAD(Si)		20KRAD(Si)		50KRAD(Si)		100KRAD(Si)		200KRAD(Si)		UNITS	
				MIN	MAX	MIN	MAX	MIN	MAX	MIN	MAX	MIN	MAX		
V_{OS}	Input Offset Voltage		1			100			130			180			μV
I_{OS}	Input Offset Current					75			75			90			nA
I_B	Input Bias Current					± 80			± 80			± 125			nA
		Input Resistance Common Mode					2 (Typ)			2 (Typ)			2 (Typ)		
	Input Voltage Range		4			± 11			± 11			± 11			V
CMRR	Common Mode Rejection Ratio	$V_{\text{CM}} = \pm 11\text{V}$				100			100			97			dB
		$V_S = \pm 4\text{V}$ to $\pm 18\text{V}$				94			94			92			90
A_{VOL}	Large-Signal Voltage Gain	$R_L \geq 2\text{k}$, $V_0 = \pm 10\text{V}$				700			700			700			V/mV
		$R_L \geq 10\text{k}$				± 11.5			± 11.5			± 11.5			V
	Maximum Output Voltage Swing	$R_L \geq 600\Omega$				± 10.0			± 10.0			± 10.0			V
SR	Slew Rate	$R_L \geq 2\text{k}$				1.7			1.7			1.7			$\text{V}/\mu\text{s}$
Z_0	Open-Loop Output Resistance	$V_0 = 0$, $I_0 = 0$				70 (Typ)			70 (Typ)			70 (Typ)			Ω
P_D	Power Dissipation					170			170			170			mW

TABLE 1A: ELECTRICAL CHARACTERISTICS

Note 1: Input offset voltage measurements are performed by automatic test equipment approximately 0.5 seconds after application of power.

Note 2: Long-term input offset voltage stability refers to the average trend line of offset voltage vs time over the first 30 days of operation. Excluding the initial hour of operation, changes in V_{OS} during the first 30 days are typically $2.5\mu\text{V}$. Refer to the typical performance curves.

Note 3: Sample tested to an LTPD of 15 on every lot. Contact factory for 100% testing of 10Hz voltage density noise.

Note 4: Parameter is guaranteed by design, characterization, or correlation to other tested parameters.

Note 5: See test circuit and frequency response curve for 0.1Hz to 10Hz tester on OP-27/OP-37 data sheet.

Note 6: See test circuit for current noise measurement on OP-27/OP-37 data sheet.

Note 7: The average input offset drift performance is within the specifications unnullled or when nulled with a pot having a range $8k\Omega$ to $20k\Omega$.

Note 8: The RH37C's inputs are protected by back-to-back diodes. Current limiting resistors are not used in order to achieve low noise. If differential input voltage exceeds $\pm 0.7\text{V}$, the input current should be limited to 25mA.

Note 9: $V_S = \pm 15\text{V}$, $V_{CM} = 0\text{V}$ unless otherwise noted.

Note 10: $T_A = 25^\circ\text{C}$, $V_S = \pm 15\text{V}$, $V_{CM} = 0\text{V}$, unless otherwise noted.

TOTAL DOSE BIAS CIRCUIT

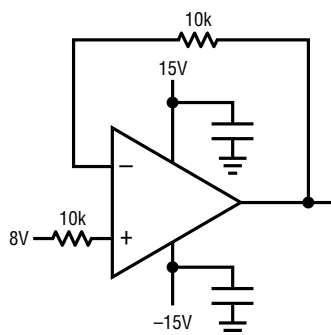

TYPICAL PERFORMANCE CHARACTERISTICS

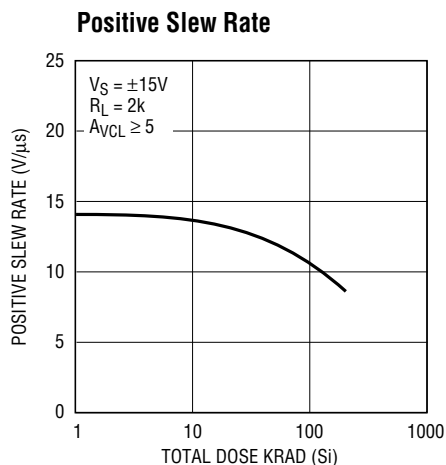

RH37C G01

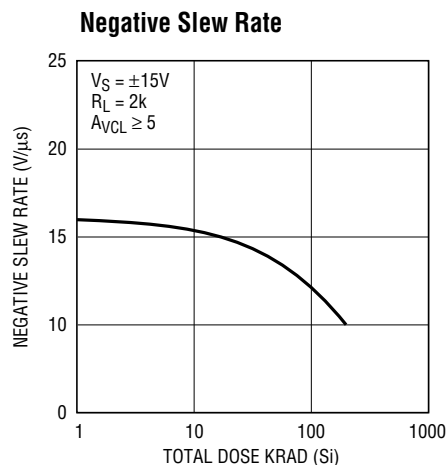

RH37C G02

TYPICAL PERFORMANCE CHARACTERISTICS

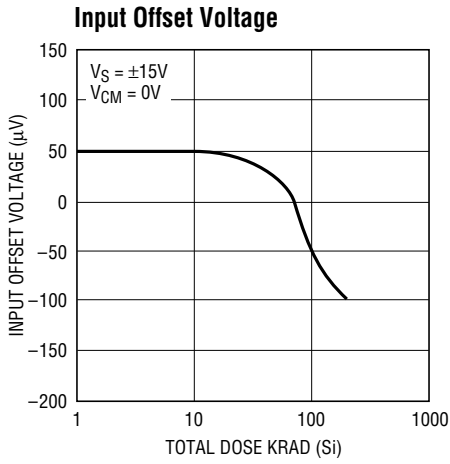

RH37C G03

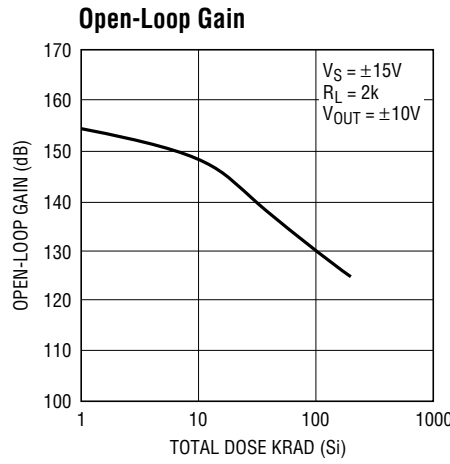

RH37C G04

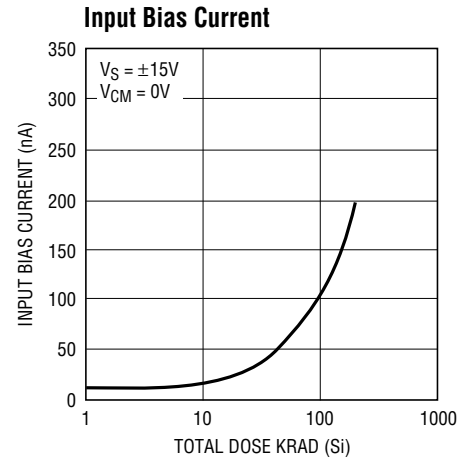

RH37C G05

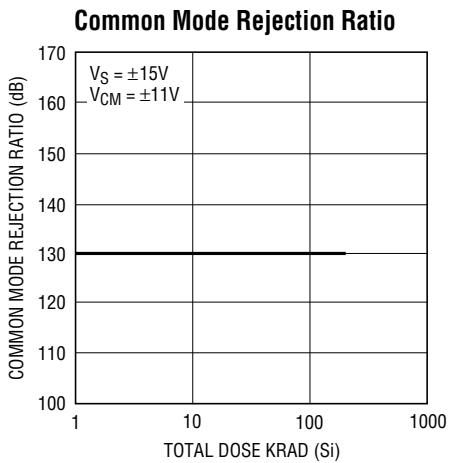

RH37C G06

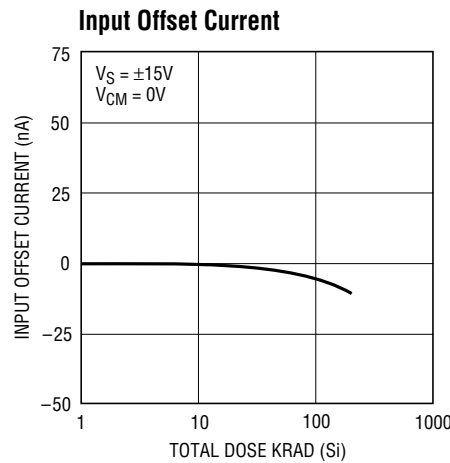

RH37C G07

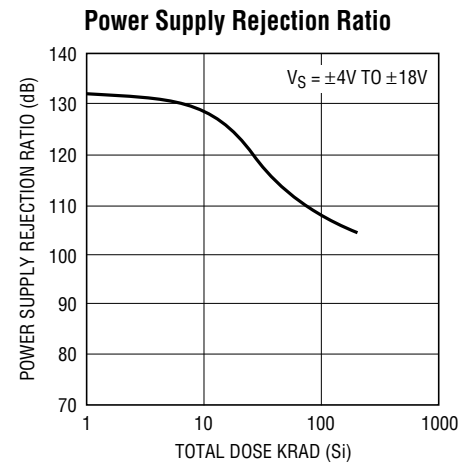

RH37C G08

TABLE 2: ELECTRICAL TEST REQUIREMENTS

MIL-STD-883 TEST REQUIREMENTS	SUBGROUP
Final Electrical Test Requirements (Method 5004)	1*,2,3,4,5,6,7
Group A Test Requirements (Method 5005)	1,2,3,4,5,6,7
Group B and D for Class S, and Group C and D for Class B End Point Electrical Parameters (Method 5005)	1

* PDA applies to subgroup 1. See PDA Test Notes.

PDA Test Notes

The PDA is specified as 5% based on failures from group A, subgroup 1, tests after cooldown as the final electrical test in accordance with method 5004 of MIL-STD-883 Class B. The verified failures of group A, subgroup 1, after burn-in divided by the total number of devices submitted for burn-in in that lot shall be used to determine the percent for the lot.

Linear Technology Corporation reserves the right to test to tighter limits than those given.