

*Industry's Highest Efficiency DC/DC Converter  
48V Input, 1.5V, 1.8V, 2.0V, 2.5V, 3.3V DC, 30A Output  
or 5.0V DC, 20A Output*

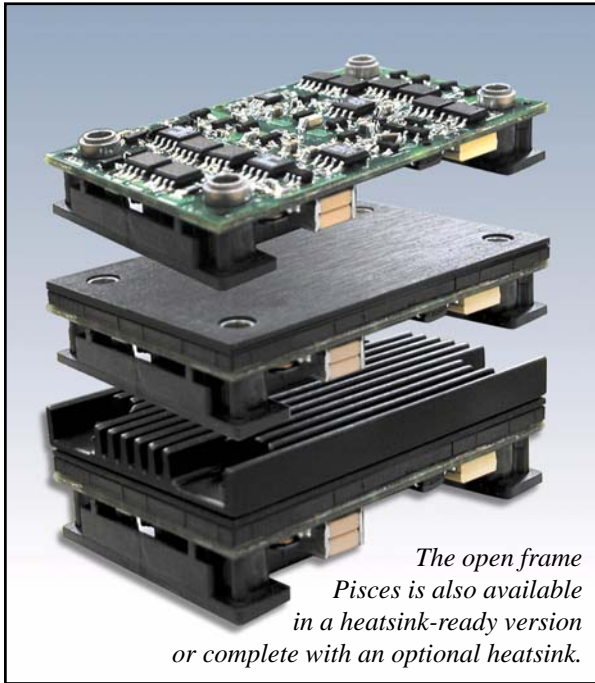

*The open frame  
Pisces is also available  
in a heatsink-ready version  
or complete with an optional heatsink.*

*The Pisces Series is the first high-efficiency quarter brick **CoolConverter™** in the Galaxy family of high-efficiency DC/DC converters.*

- Industry Standard Pinout and Footprint
- Highest Efficiency in the Industry, 92% at 3.3V, 15A; 90% at 3.3V, 30A
- No Heat Sink Required
- Very Low Common-mode Noise for a Commercial DC/DC Converter
- Two-stage Input Filter
- Constant Switching Frequency
- Remote Sense
- Open Frame Design
- Optional Low Profile Heatsink or Baseplate for Improved Thermal Performance
- Header with M3 Metal Inserts for Mechanical Connection to PCB
- Two Year Warranty

## CONTROL FUNCTIONS

- Uses Patent Pending Power Supply Control and Architecture
- Microprocessor Controlled
- Primary-side Enable, Choice of Logic

## PROTECTION FEATURES

- Over Temperature Protection
- Over Voltage Protection
- Over Current Protection
- Over/Under Input Voltage Protection

## TYPICAL CHARACTERISTICS

- Output Setpoint Accuracy:  $\pm 1\%$
- Load Regulation:  $\pm 0.2\%$
- Line Regulation:  $\pm 0.2\%$
- Regulation over Line, Load, and Temperature:  $\pm 2\%$
- Low Output Ripple
- Output Trim

## GENERAL SPECIFICATIONS

$V_{IN} = 48V_{DC}$ ,  $T_A @ 25^{\circ}C$ , 300 LFM Airflow,  $V_{OUT} = 3.3V$ ,  $I_{OUT} =$  Full Load unless otherwise noted.

Available output power depends on ambient temperature and good thermal management. (See application graphs for limits.)

<b>Input Characteristics</b>				
Parameter	Min	Typ	Max	Units
Operating Input Voltage	36	48	75	$V_{DC}$
Input Current (Model Dependent)			5	A
Input Capacitance		4.5		$\mu F$
Input Hysteresis, Low Line		2		$V_{DC}$
<b>Output Characteristics</b>				
Regulation Over Line, Load & Temperature	98		102	% $V_{NOM}$
Voltage Ripple			20	mV RMS
Voltage Ripple, 20MHz BW			150	mV P-P
Current Range	0		30	A
Current Limit Inception	31		37	A
Short Circuit Current, Peak (see Note below)			41	A
Output Transient Response, 50% to 75% load change, 1A/ $\mu$ sec			5	% $V_{OUT}$
Settling Time to $\pm 1\%$			300	$\mu S$
Turn-on Time to 98% $V_{nom}$			35	mS
Output Overshoot at Turn-on			1	% $V_{OUT}$
Trim Range	90		110	% $V_{OUT}$
Overvoltage Protection, Latching		130		% $V_{OUT}$
<b>Isolation</b>				
Isolation Test Voltage, Input/Output (Basic)	2000			$V_{DC}$
Isolation Resistance	10			M $\Omega$
<b>Features</b>				
Overtemperature Protection, Thermal Sensor, Latching*			117	$^{\circ}C$
Input, Output Ripple Frequency, Fixed		200		kHz

Notes: During short circuit, converter will shut down and attempt to restart once per second. The average current during this condition will be very low and the device can be safely left in this condition continuously. For specific output voltage specifications, see the corresponding detailed data sheet.

\*PCB less than 130 $^{\circ}C$

### General Specifications

Operating Temperature	-40 $^{\circ}C$ to +100 $^{\circ}C$
Storage Temperature	-55 $^{\circ}C$ to +125 $^{\circ}C$
Relative Humidity	10% to 95% RH, Non-condensing
Vibration	2 to 9Hz, 3mm disp., 9 to 200Hz 1g
Material Flammability	UL V-0
Weight	35 grams
MTBF	BELLCORE TR-332 1,600,000 hours

### Approvals and Standards

UL and c-UL Recognized Component, TUV, UL1950, CSA 22.2 No. 950, IEC/EN 60950\*\*

EMC Characteristics:

Designed to meet emission and immunity requirements per EN55022, CISPR 22, Class B, and CISPR 24.

\*\* An external fuse shall be used to comply with the requirements.

## CoolConverter™

Galaxy's proprietary **CoolConverter™** provides:

- Patent Pending single-stage power conversion architecture, control, and magnetic design allow unprecedented power density and efficiency in an isolated power supply.
- An advanced microcontroller reduces parts count while adding features, performance, and flexibility in the design.
- Low common-mode noise as a result of lower capacitance in the transformer compared to planar magnetics and metal baseplate designs.
- Higher reliability than planar transformer designs that can suffer from via fatigue from thermal cycling, and metal baseplate designs with board to board interconnects that are subject to mechanical stress on electrical connections.

## PROTECTION AND CONTROL

### Valid Input Voltage Range:

The converter measures the input voltage and will not allow operation outside of the input voltage specification. As shown by the graphs, hysteresis is added to both the high and low voltage to prevent the converter from turning on and off repeatedly when the voltage is held near either voltage extreme. At low line this assures the maximum input current is not exceeded; at high line this assures the semiconductor devices in the converter are not damaged by excessive voltage stress.

### ON/OFF Logic Option:

The ON/OFF control logic can be either Negative (standard) or Positive to enable the converter. For Negative logic, the ON/OFF pin is brought below 1.0 V with respect to the -INPUT pin to enable the converter. The pull down must be able to sink 100 microamps. For Positive logic, the ON/OFF pin is brought to greater than 4.0 V with respect to the -INPUT pin and must be able to source more than 100  $\mu$ A and be limited to less than 10 V. To request the Positive logic version, add the suffix (P) to the standard part number. The positive version has a built-in pull up resistor of approximately 100 k $\Omega$ .

Overvoltage Lockout

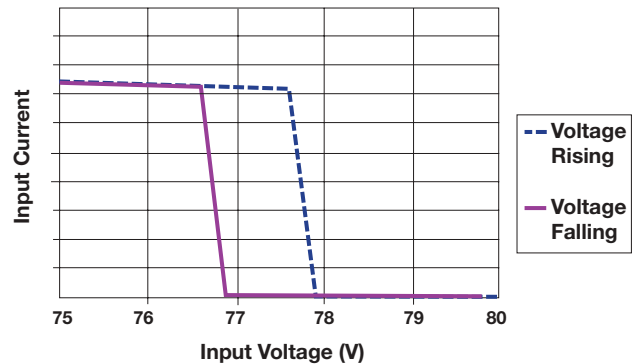

Undervoltage Lockout

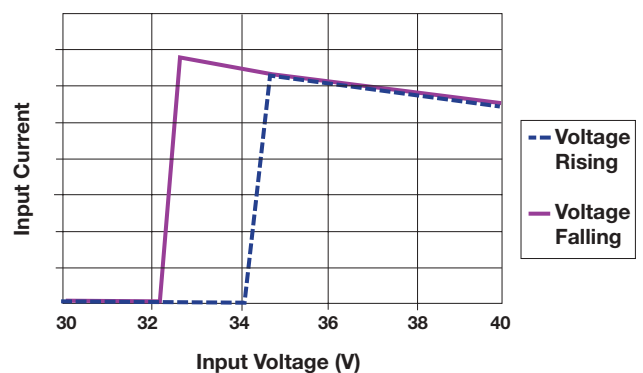

# APPLICATION NOTES

## Output Over Voltage Protection:

The output voltage is constantly monitored by the microprocessor and a redundant secondary-side crowbar circuit that is set to a higher trip point than the microprocessor protection. If the output voltage exceeds the over-voltage specification, the microprocessor will latch the converter off. To turn the converter on requires either cycling the ON/OFF pin or power to the converter. This advanced feature prevents the converter from damaging the load if there is a converter failure or application error. If non-latching is required, consult factory.

## Thermal Shutdown:

The printed circuit board temperature is measured using a semiconductor sensor. If the maximum rated temperature is exceeded, the converter is latched off. To re-enable the converter requires cycling the ON/OFF pin or power to the converter. If non-latching is required, consult factory.

## Control Options:

As the behavior of the circuit is determined by firmware in the microcontroller, specific customer requirements such as

- non-latching thermal protection
- custom valid input voltage range
- controlled delay from initiating an ON/OFF signal for power sequencing

can be accomplished with no change to hardware.

The standard behavior was chosen based on system design experience but we understand that customers often have their own requirements.

Please consult Galaxy Power for your special needs.

## Remote Sense:

The output voltage is regulated at the point where the sense pins connect to the power output pins. Total sense compensation should not exceed 0.4V or 10% of  $V_{out}$ , whichever is greater.

## Safety:

An external input fuse must always be used to meet these safety requirements.

## Trim:

To trim the output voltage higher, connect the required trim resistor from the Trim pin to the +Sense pin. To trim the output voltage lower, connect the required trim resistor from the Trim pin to the -Sense pin. See diagram below.

### Trim-down

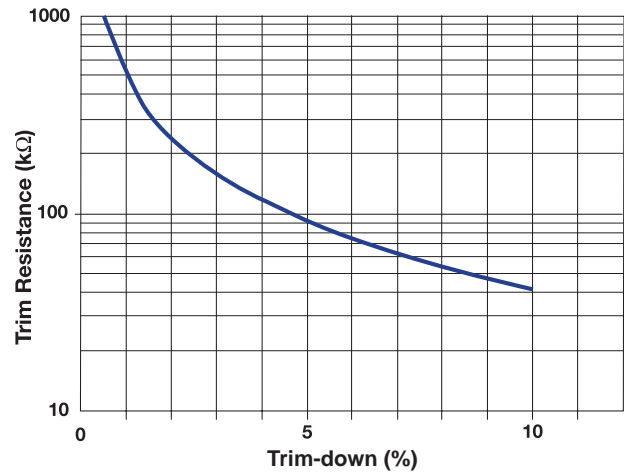

$$R_{\text{TRIM-DOWN}} = \left\{ \frac{100}{\Delta\%} - 2 \right\} 5.11\text{k}\Omega$$

### Trim-up (for 3.3V)

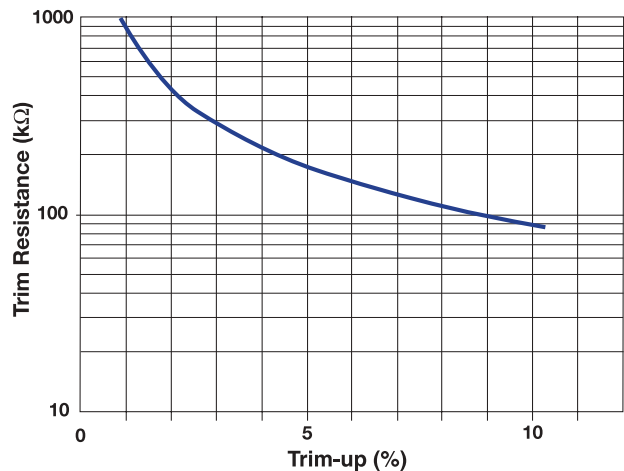

$$R_{\text{TRIM-UP}} = \left\{ \frac{V_o (100 + \Delta\%)}{1.225\Delta\%} - \frac{(100 + 2\Delta\%)}{\Delta\%} \right\} 5.11\text{k}\Omega$$

## External Output Trimming

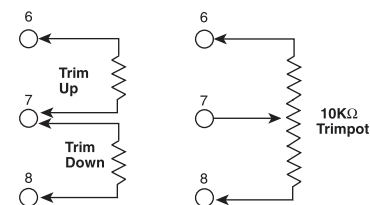

# GHPW3V3-30 OPERATION

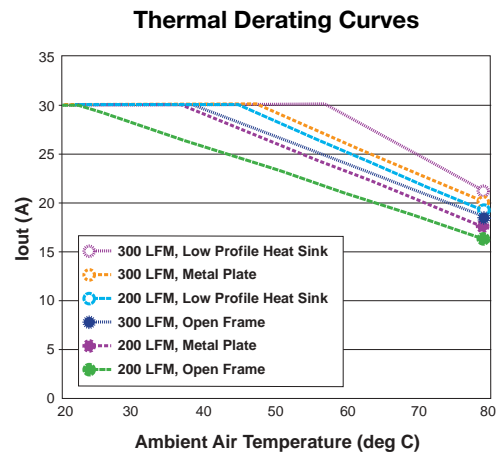
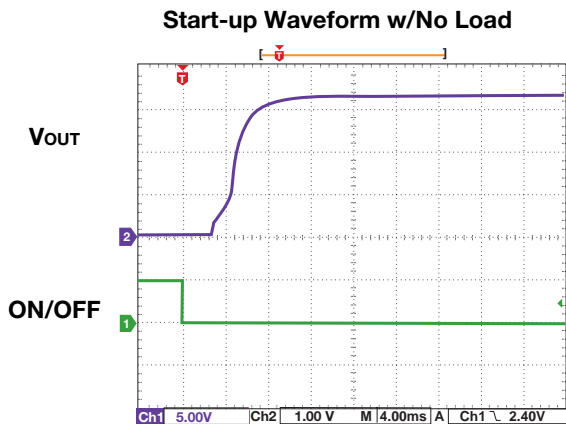
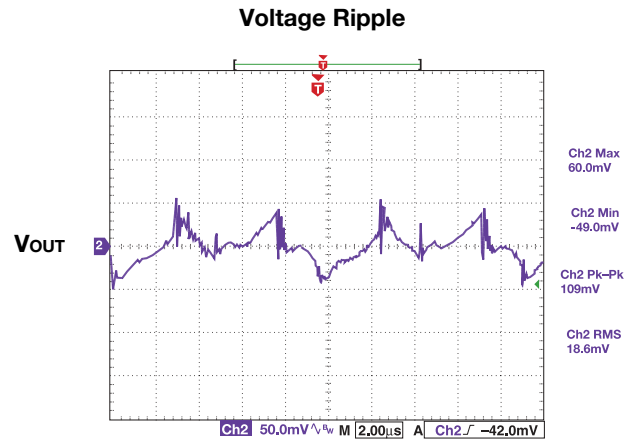
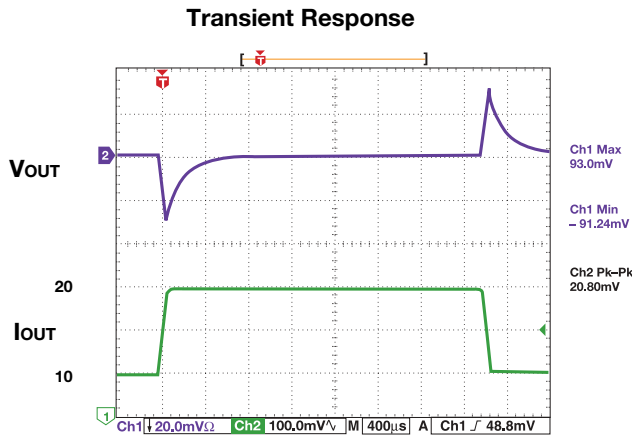
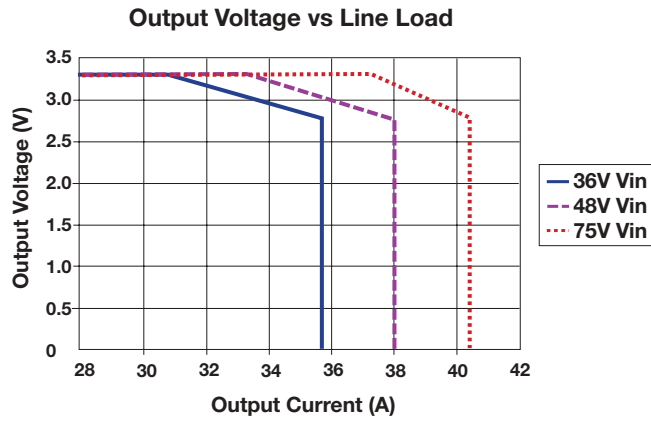
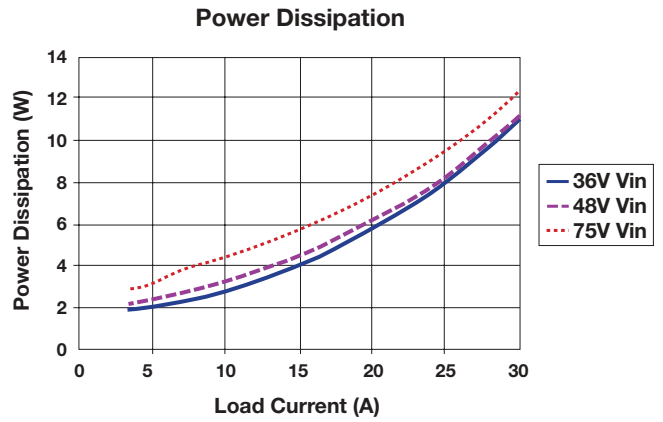
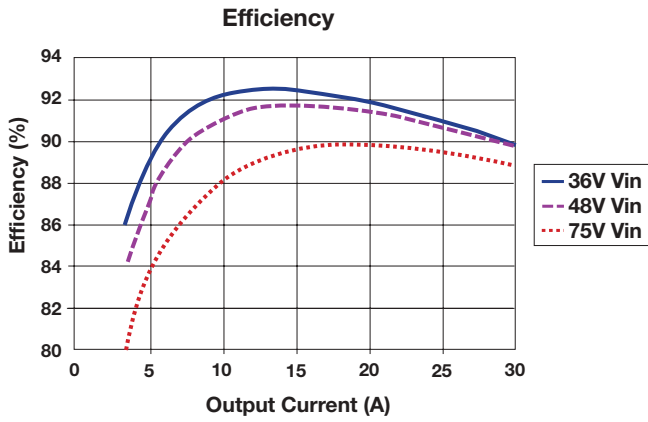

# PACKAGE DETAIL

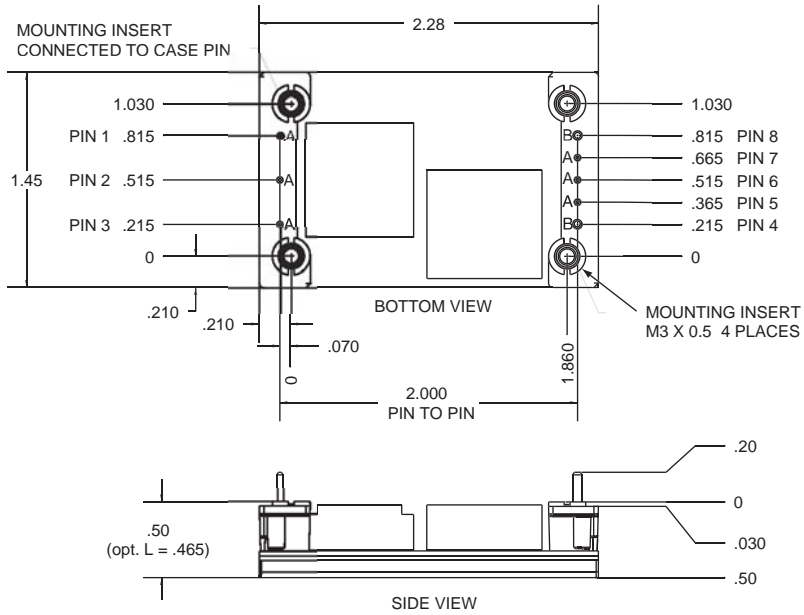

Pin	Function	Pin Dia. (in.)
1	- Input	0.040
2	On/Off	0.040
3	+ Input	0.040
4	+ Output	0.060
5	+ Sense	0.040
6	Trim	0.040
7	- Sense	0.040
8	- Output	0.060

**Notes:**

- Mechanical tolerances  
x.xxx in. = ±0.005 in.  
x.xx in. = ±0.01 in.
- Pin material: brass with tin/lead plating over nickel
- Workmanship: Meets or exceeds IPC-A-610B Class II

# ORDERING INFORMATION

Standard Model Number	Output Voltage	Max Current	Efficiency	
			Half Load	Full Load
<b>48V Input Models (Designated W)</b>				
GHPW5V020*	5.0V	20A	91%	90%
GHPW3V330*	3.3V	30A	92%	90%
GHPW2V530*	2.5V	30A	90%	87%
GHPW2V030*	2.0V	30A	89%	85%
GHPW1V830*	1.8V	30A	88%	84%
GHPW1V530*	1.5V	30A	86%	82%

Standard Model Number	Output Voltage	Max Current	Efficiency	
			Half Load	Full Load
<b>24V Input Models (Designated C)</b>				
GHPC5V020*	5.0V	20A	90%	88%
GHPC3V330*	3.3V	30A	91%	89%
GHPC2V530*	2.5V	30A	89%	86%
GHPC2V030*	2.0V	30A	88%	84%
GHPC1V830*	1.8V	30A	87%	83%
GHPC1V530*	1.5V	30A	85%	81%

### Pisces Heatsink Part Numbers

Part Number	Height	Typical Thermal Performance	
		Natural Convection Power Dissipation*	Forced Convection Thermal Resistance**
001	0.25"	5W	5.8°C/W
002	0.50"	7W	3.2°C/W
003	1.00"	11W	2.0°C/W

\*@ 60°C rise heatsink to ambient

\*\* @ 300'/min.

### \* Options:

*P* = Positive Logic Version; High = On

*M* = 0.145" Pins ( $\pm 0.01$ " )

*S* = 0.12" Pins ( $\pm 0.01$ " )

*R* = Heatsink Ready

*T* = Tuned model\*\*

*L* = Low Profile (0.465" height)s

### Example:

(All options shown)

**GHPW 3V330 P S R T L 00X**

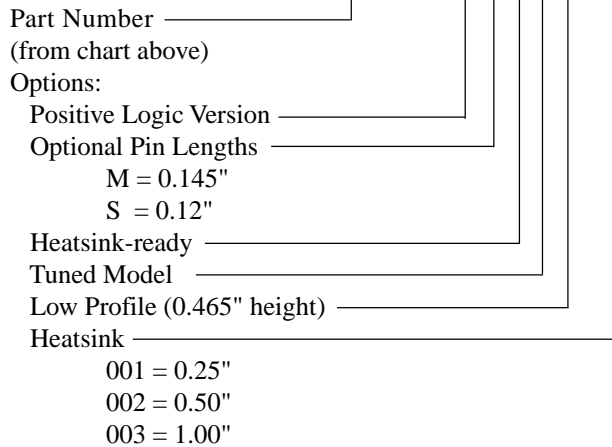

### \*\*T (Tuned Model) Option

Designed for higher di/dt and  $\Delta I$  applications, the transient response has been modified to take advantage of the capacitance on the customer's PCB. This unit requires a minimum load capacitance of 5600 $\mu$ F with an impedance magnitude of less than 0.005 $\Omega$  at 15kHz. It offers a minimum 3X improvement in the peak response compared to a standard unit.

Galaxy Power Inc. warrants to the original purchaser that the products conform to this data sheet and are free from material and workmanship defects for a period of two (2) years from the date of manufacture, if this product is used within specified conditions. Galaxy Power Inc. reserves the right to make changes to the product(s) or information contained herein without notice. No liability is assumed as a result of their use or application. No rights under any patent accompany the sale of any such products or information. For additional details on this limited warranty consult the factory.



**GALAXY  
POWER**  
Incorporated

155 Flanders Road ♦ Westborough, MA 01581  
508-870-9775 ♦ Fax: 508-870-9796  
e-mail: galaxy@galaxypwr.com  
website: <http://www.galaxypwr.com>