

Multilayer Surface Mount Transient Voltage Surge Suppressors

The ML Series is a family of Transient Voltage Surge Suppression devices based on the Littelfuse Multilayer fabrication technology. These components are designed to suppress a variety of transient events, including those specified in by the IEC and other standards used for Electromagnetic Compliance (EMC). The ML Series is typically applied to protect integrated circuits and other components at the circuit board level.

The wide operating voltage and energy range make the ML Series suitable for numerous applications on power supply, control and signal lines.

The ML Series is manufactured from semiconducting ceramics, providing bi-directional voltage clamping and is supplied in leadless, surface mount form compatible with modern reflow and wave soldering procedures.

It can operate over a wider temperature range than zener diodes, is inherently bi-directional, and has a much smaller footprint than plastic-housed components.

Littelfuse Inc. manufactures other Multilayer Series products. See the MLE Series data sheet for ESD applications, MHS series data sheet for high speed ESD applications, the MLN for multiline protection and the AUML Series for automotive applications.

Features

- Leadless 0402, 0603, 0805, 1206 and 1210 Chip Size
- Multilayer Ceramic Construction Technology
- -55°C to +125°C Operating Temperature Range
- Operating Voltage Range $V_{M(DC)} = 5.5V$ to 120V
- Rated for Surge Current (8x20 μ s)
- Rated for Energy (10x1000 μ s)
- Inherent Bi-directional Clamping
- No Plastic or Epoxy Packaging Assures Better than 94V-0 Flammability Rating.
- Standard Low Capacitance Types Available

Applications

- Suppression of Inductive Switching or Other Transient Events Such as EFT and Surge Voltage at the Circuit Board Level.
- ESD Protection for Components Sensitive to IEC 61000-4-2, MIL-STD 883C Method 3015.7 and Other Industry Specifications (See Also the MLE and MLN Series).
- Provides On-Board Transient Voltage Protection for ICs and Transistors.
- Used to Help Achieve Electromagnetic Compliance of End Products
- Replace Larger Surface Mount TVS Zeners in Many Applications

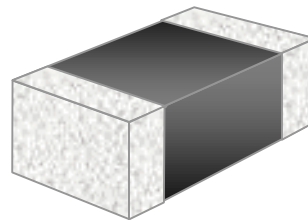

ML Series

Absolute Maximum Ratings. For ratings of individual members of a series, see Device Ratings and Specifications table.

	ML Series	UNITS
Continuous:		
Steady State Applied Voltage:		
DC Voltage Range ($V_{M(DC)}$).....	3.5 to 120	V
AC Voltage Range ($V_{M(AC)(RMS)}$).....	2.5 to 107	V
Transient:		
Non-Repetitive Surge Current, 8/20 μ s Waveform (I_{TM}).....	4 to 500	A
Non-Repetitive Surge Energy, 10/1000 μ s Waveform (W_{TM}).....	0.02 to 1.2	J
Operating Ambient Temperature range (T_A).....	-55 to +125	°C
Storage Temperature (T_{STG}).....	-55 to +150	°C
Temperature Coefficient (αV) of Clamping Voltage (V_C) at 1A.....	<0.01	%/°C

Device Ratings and Specifications

PART NUMBER	MAXIMUM RATINGS (125°C)					SPECIFICATIONS (25°C)		
	MAXIMUM CONTINUOUS WORKING VOLTAGE		MAXIMUM NON-REPETITIVE SURGE CURRENT (8/20 μ s)	MAXIMUM NON-REPETITIVE SURGE ENERGY (10/1000 μ s)	MAXIMUM CLAMPING VOLTAGE AT 10A (OR AS NOTED) (8/20 μ s)	NOMINAL VOLTAGE AT 1mA DC TEST CURRENT		TYPICAL CAPACITANCE AT 1MHz
	$V_{M(DC)}$	$V_{M(AC)}$	I_{TM}	W_{TM}	V_C	$V_{N(DC)}$ MIN	$V_{N(DC)}$ MAX	C
	(V)	(V)	(A)	(J)	(V)	(V)	(V)	(pF)
V3.5MLA0603	3.5	2.5	30	0.1	10 at 2A	3.7	7.0	1100
V3.5MLA0805	3.5	2.5	120	0.3	10 at 5A	3.7	7.0	2200
V3.5MLA0805L	3.5	2.5	40	0.1	10 at 2A	3.7	7.0	1200
V3.5MLA1206	3.5	2.5	100	0.3	14	3.7	7.0	6000
V5.5MLA0402	5.5	4.0	20	0.050	15.5 at 1A	7.1	9.3	280
V5.5MLA0603	5.5	4.0	30	0.1	15.5 at 2A	7.1	9.3	660
V5.5MLA0805	5.5	4.0	120	0.3	15.5 at 5A	7.1	9.3	1600
V5.5MLA0805L	5.5	4.0	40	0.1	15.5 at 2A	7.1	9.3	860
V5.5MLA1206	5.5	4.0	150	0.4	15.5	7.1	9.3	4500
V9MLA0402	9	6.5	20	0.050	22 at 1A	11	14	120
V9MLA0402L	9	6.5	4	0.020	25 at 1A	11	14	33
V9MLA0603	9	6.5	30	0.1	23 at 2A	11	16	420
V9MLA0805L	9	6.5	40	0.1	20 at 2A	11	14	450
V12MLA0805L	12	9.0	40	0.1	25 at 2A	14	18.5	350
V14MLA0402	14	10	20	0.050	30 at 1A	15.9	20.3	70
V14MLA0603	14	10	30	0.1	30 at 2A	15.9	20.3	150
V14MLA0805	14	10	120	0.3	30 at 5A	15.9	20.3	480
V14MLA0805L	14	10	40	0.1	30 at 2A	15.9	20.3	270
V14MLA1206	14	10	150	0.4	30	15.9	20.3	1600

ML Series

PART NUMBER	MAXIMUM RATINGS (125°C)					SPECIFICATIONS (25°C)		
	MAXIMUM CONTINUOUS WORKING VOLTAGE		MAXIMUM NON-REPETITIVE SURGE CURRENT (8/20µs)	MAXIMUM NON-REPETITIVE SURGE ENERGY (10/1000µs)	MAXIMUM CLAMPING VOLTAGE AT 10A (OR AS NOTED) (8/20µs)	NOMINAL VOLTAGE AT 1mA DC TEST CURRENT		TYPICAL CAPACITANCE AT 1MHz
	V _{M(DC)}	V _{M(AC)}	I _{TM}	W _{TM}	V _C	V _{N(DC)} MIN	V _{N(DC)} MAX	C
	(V)	(V)	(A)	(J)	(V)	(V)	(V)	(pF)
V18MLA0402	18	14	20	0.050	40 at 1A	22	28	40
V18MLA0603	18	14	30	0.1	40 at 2A	22	28	125
V18MLA0805	18	14	120	0.3	40 at 5A	22	28	450
V18MLA0805L	18	14	40	0.1	40 at 2A	22	28	250
V18MLA1206	18	14	150	0.4	40	22	28	1100
V18MLA1210	18	14	500	2.5	40	22	28	1250
V26MLA0603	26	20	30	0.1	58 at 2A	31	38	90
V26MLA0805	26	20	100	0.3	58 at 5A	29.5	38.5	190
V26MLA0805L	26	20	40	0.1	58 at 2A	29.5	38.5	115
V26MLA1206	26	20	150	0.6	56	29.5	38.5	900
V26MLA1210	26	20	300	1.2	54	29.5	38.5	1000
V30MLA0603	30	25	30	0.1	65 at 2A	37	46	75
V30MLA0805L	30	25	30	0.1	65 at 2A	37	46	80
V30MLA1210	30	25	280	1.2	62	35	43	1575
V30MLA1210L	30	25	220	0.9	62	35	43	1530
V33MLA1206	33	26	180	0.8	72	38	49	550
V42MLA1206	42	30	180	0.8	86	46	60	550
V48MLA1210	48	40	250	1.2	100	54.5	66.5	450
V48MLA1210L	48	40	220	0.9	100	54.5	66.5	430
V56MLA1206	56	40	180	1.0	110	61	77	150
V60MLA1210	60	50	250	1.5	120	67	83	375
V68MLA1206	68	50	180	1.0	130	76	90	150
V85MLA1210	85	67	250	2.5	160	95	115	225
V120MLA1210	120	107	125	2.0	230	135	165	65

NOTES:

1. L -suffix is a low capacitance and energy version, Contact your Littelfuse Sales Representative for custom capacitance requirements.
2. Typical leakage at 25°C <25µA, maximum leakage 50µA at V_{M(DC)}; for 0402-size, typical leakage <5µA, maximum leakage 10µA at V_{M(DC)};
3. Average power dissipation of transients for 0402, 0603, 0805, 1206 and 1210 sizes not to exceed 0.03W, 0.05W, 0.1W, 0.1W and 0.15W respectively.

Temperature De-rating

When transients occur in rapid succession, the average power dissipation is the energy (watt-seconds) per pulse times the number of pulses per second. The power so developed must be within the specifications shown on the Device Ratings and Specifications table for the specific device. For applications exceeding 125°C ambient temperature, the peak surge current and energy ratings must be derated as shown in Figure 1.

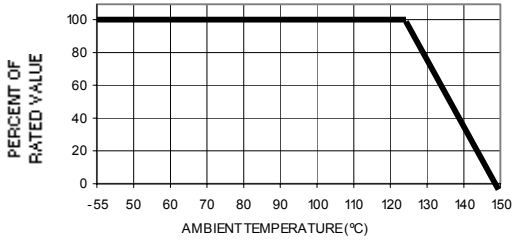
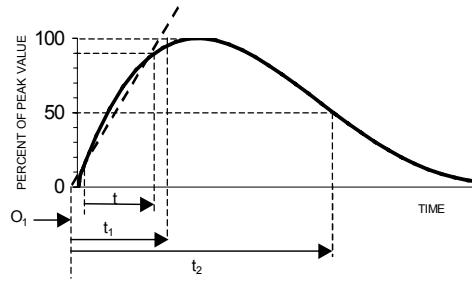

FIGURE 1: PEAK CURRENT AND ENERGY DERATING CURVE



**Figure 1:
FIGURE 2: PEAK PULSE CURRENT TEST WAVEFORM FOR CLAMPING VOLTAGE**

O_1 = VIRTUAL ORIGIN OF WAVE
 t = TIME FROM 10% TO 90% OF PEAK
 t_1 = VIRTUAL FRONT TIME = $1.25 \times t$
 t_2 = VIRTUAL TIME TO HALF VALUE (IMPULSE DURATION)
 EXAMPLE:
 FOR AN 8/20 μ s CURRENT WAVEFORM:
 8μ s = t_1 = VIRTUAL FRONT TIME
 20μ s = t_2 = VIRTUAL TIME TO HALF VALUE

Maximum Transient V-I Characteristic Curves

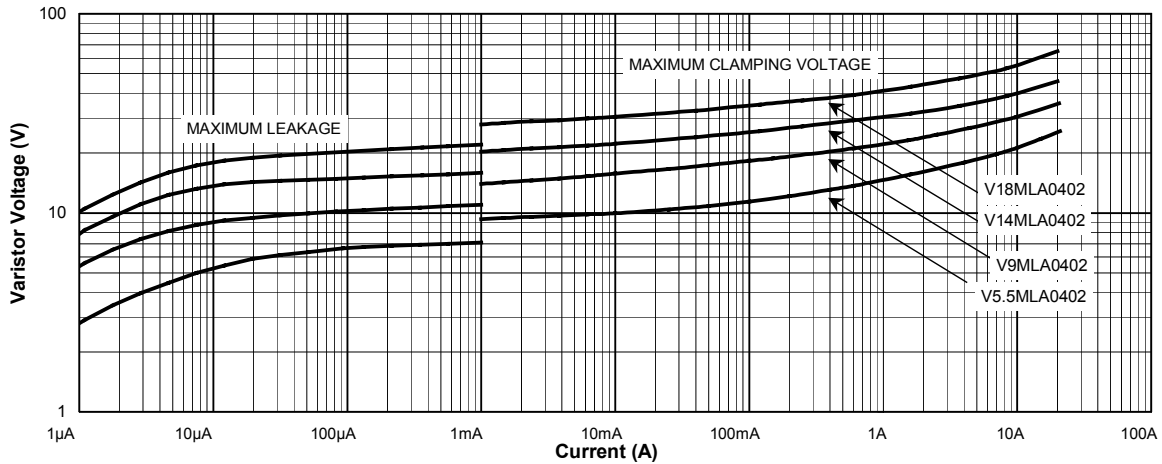

FIGURE 3: LIMIT V-I CHARACTERISTIC FOR V5.5MLA0402 TO V18MLA0402

ML Series

Maximum Transient V-I Characteristic Curves (Continued)

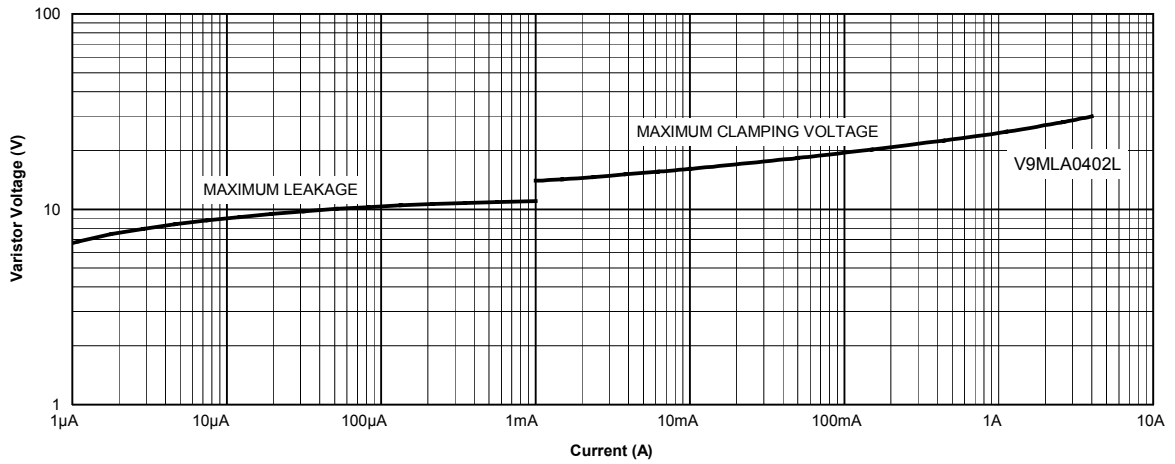

FIGURE 4: LIMIT V-I CHARACTERISTIC FOR V9MLA0402L

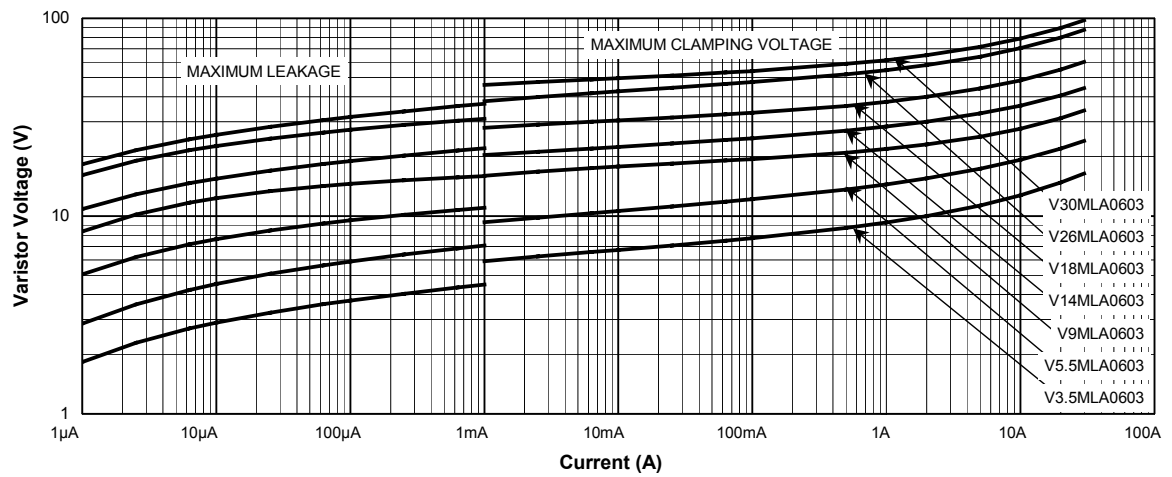

FIGURE 5: LIMIT V-I CHARACTERISTIC FOR V3.5MLA0603 TO V30MLA0603

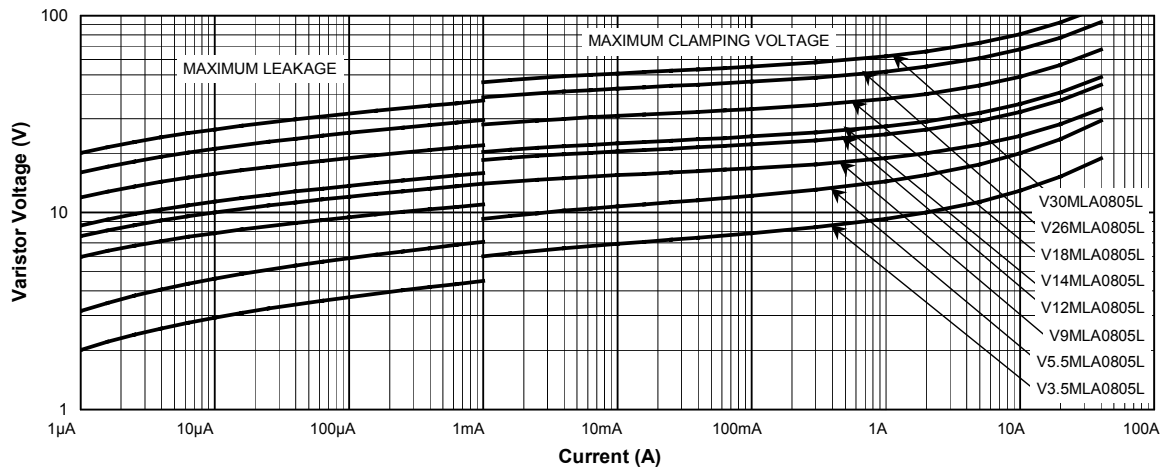

FIGURE 6: LIMIT V-I CHARACTERISTIC FOR V3.5MLA0805L TO V30MLA0805L

Maximum Transient V-I Characteristic Curves (Continued)

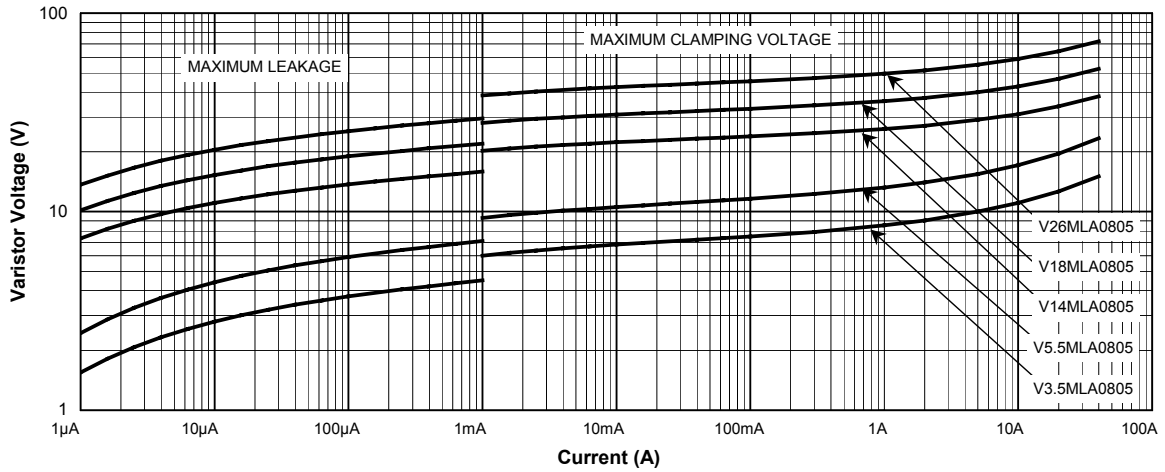

FIGURE 7: LIMIT V-I CHARACTERISTIC FOR V3.5MLA0805 TO V26MLA0805

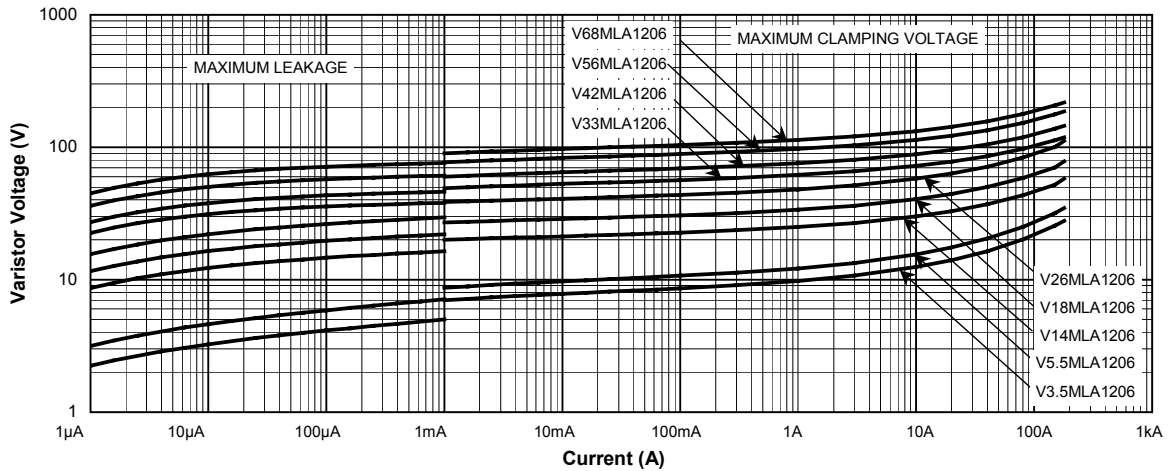

FIGURE 8: LIMIT V-I CHARACTERISTIC FOR V3.5MLA1206 TO V68MLA1206

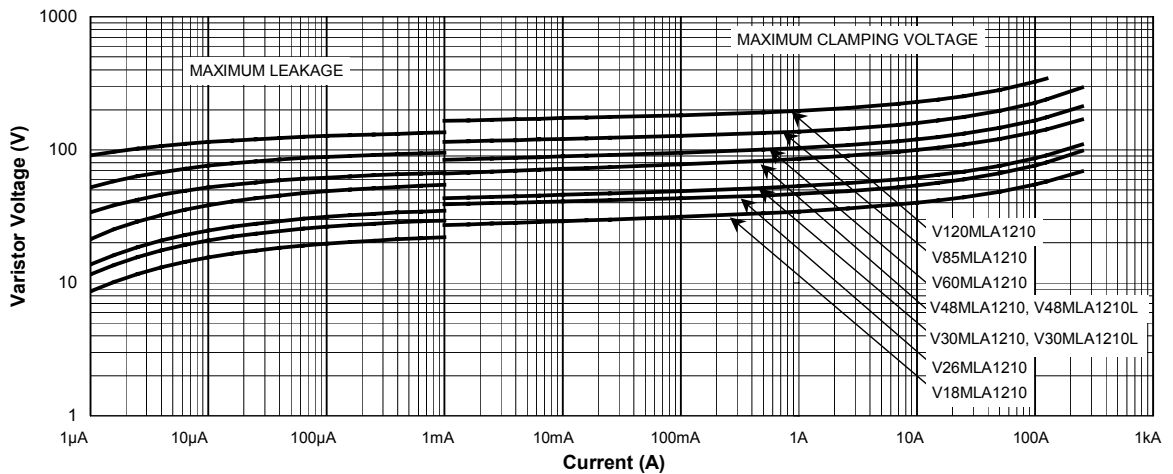

FIGURE 9: LIMIT V-I CHARACTERISTIC FOR V18MLA1210 TO V120MLA1210

Device Characteristics

At low current levels, the V-I curve of the multilayer transient voltage suppressor approaches a linear (ohmic) relationship and shows a temperature dependant effect (figure 10). At or below the maximum working voltage, the suppressor is in a high resistance mode (approaching $10^6\Omega$ at its maximum rated working voltage). Leakage currents at maximum rated voltage are below $50\mu A$, typically $25\mu A$; for 0402-size: below $10\mu A$, typically $5\mu A$.

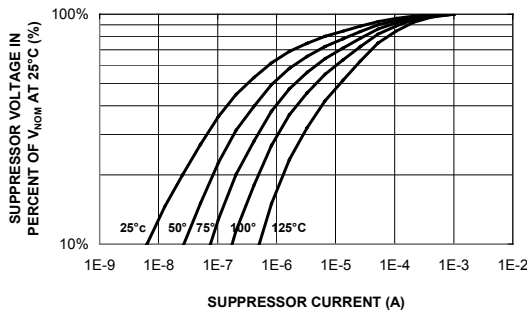

FIGURE 10: TYPICAL TEMPERATURE DEPENDANCE OF THE CHARACTERISTIC CURVE IN THE LEAKAGE REGION

Speed of Response

The Multilayer Suppressor is a leadless device. Its response time is not limited by the parasitic lead inductances found in other surface mount packages. The response time of the Zinc Oxide dielectric material is less than 1nanosecond and the ML can clamp very fast dV/dt events such as ESD. Additionally, in “real world” applications, the associated circuit wiring is often the greatest factor affecting speed of response. Therefore, transient suppressor placement within a circuit can be considered important in certain instances.

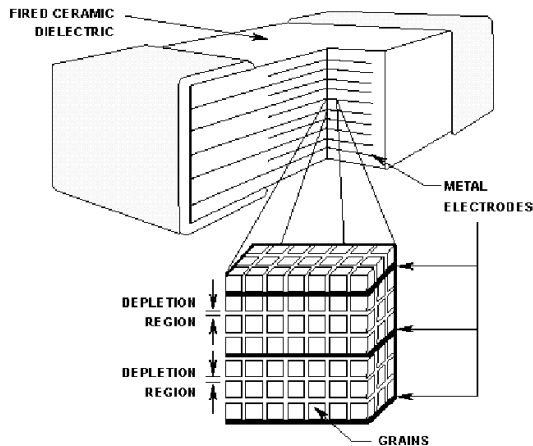

FIGURE 11: MULTILAYER INTERNAL CONSTRUCTION

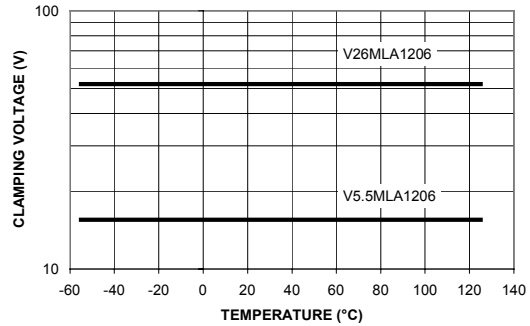

FIGURE 12: CLAMPING VOLTAGE OVER TEMPERATURE (V_C AT 10A)

Energy Absorption/Peak Current Capability

Energy dissipated within the ML is calculated by multiplying the clamping voltage, transient current and transient duration. An important advantage of the multilayer is its interdigitated electrode construction within the mass of the dielectric material. This results in excellent current distribution and the peak temperature per energy absorbed is very low. The matrix of semiconducting grains combine to absorb and distribute transient energy (heat) (Figure 11). This dramatically reduces the peak temperature, thermal stresses and enhances device reliability.

As a measure of the device capability in energy and peak current handling, the V26MLA1206A part was tested with multiple pulses at its peak current rating (150A, 8/20 μs). At the end of the test, 10,000 pulses later, the device voltage characteristics are still well within specification (figure 13).

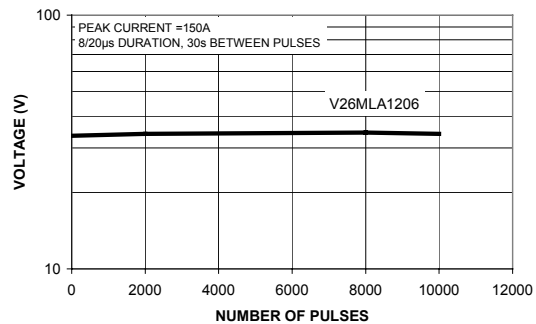

FIGURE 13: REPETITIVE PULSE CAPABILITY

Soldering Recommendations

The principal techniques used for the soldering of components in surface mount technology are infrared (IR) re-flow, vapour phase re-flow and wave soldering. Typical profiles are shown in figures 14, 15 and 16. When wave soldering, the ML suppressor is attached to the circuit board by means of an adhesive. The assembly is then placed on a conveyor and run through the soldering process to contact the wave. With IR and vapour phase re-flow, the device is placed in a solder paste on a substrate. As the solder paste is heated, it re-flows and solders the unit to the board.

The recommended solder for the ML suppressor is a 62/36/2 (Sn/Pb/Ag), 60/40 (Sn/Pb) or 63/37 (Sn/Pb). Littelfuse also recommends an RMA solder flux.

Wave soldering is the most strenuous of the processes. To avoid the possibility of generating stresses due to thermal shock, a preheat stage in the soldering process is recommended, and the peak temperature of the solder process should be rigidly controlled. For 0402-size devices, IR re-flow is recommended.

When using a re-flow process, care should be taken to ensure that the ML chip is not subjected to a thermal gradient steeper than 4 degrees per second; the ideal gradient being 2 degrees per second. During the soldering process, preheating to within 100 degrees of the solder's peak temperature is essential to minimize thermal shock. Examples of the soldering conditions for the ML suppressor are given in the tables below.

Once the soldering process has been completed, it is still necessary to ensure that any further thermal shocks are avoided. One possible cause of thermal shock is hot printed circuit boards being removed from the solder process and subjected to cleaning solvents at room temperature. The boards must be allowed to cool gradually to less than 50°C before cleaning.

Termination Options

Littelfuse offers two types of electrode termination finish for the Multilayer product series:

1. Silver/Platinum (standard, not available for 0402)
2. Silver/Palladium (optional)

(The ordering information section describes how to designate them.)

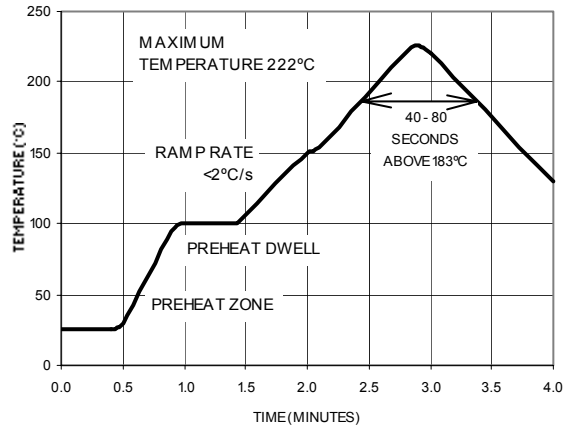

FIGURE 14: REFLOW SOLDER PROFILE

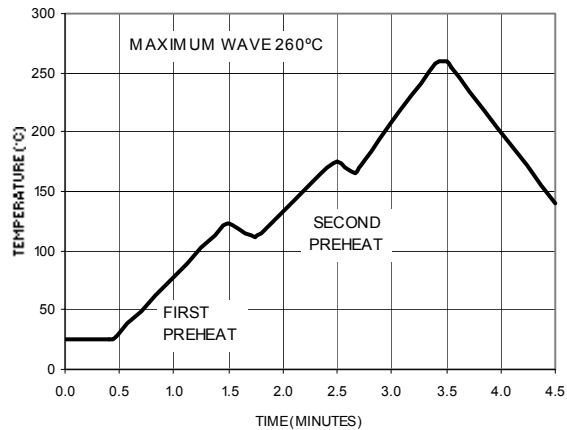

FIGURE 15: WAVE SOLDER PROFILE

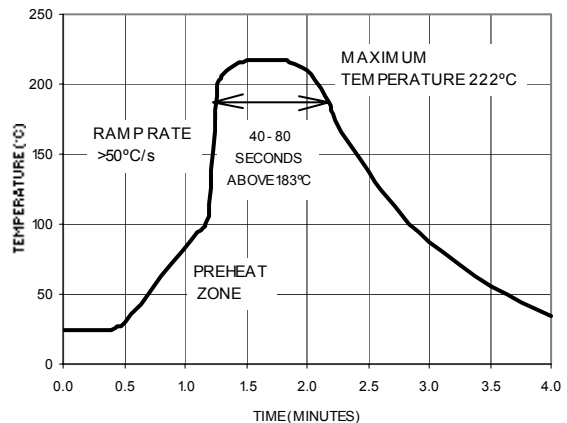
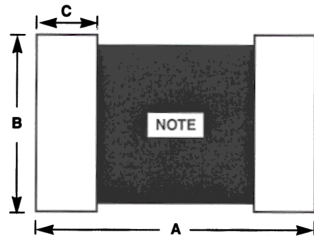

FIGURE 16: VAPOR PHASE SOLDER PROFILE

ML Series

Recommended Pad Outline



Note: Avoid metal runs in this area

TABLE 1: PAD LAYOUT DIMENSIONS

DIMENSION	PAD SIZE									
	1210 SIZE DEVICE		1206 SIZE DEVICE		0805 SIZE DEVICE		0603 SIZE DEVICE		0402 SIZE DEVICE	
	Inch	mm	Inch	mm	Inch	mm	Inch	mm	Inch	mm
A	0.219	5.53	0.203	5.15	0.144	3.65	0.110	2.80	0.100	2.54
B	0.147	3.73	0.103	2.62	0.084	2.13	0.064	1.62	0.048	1.22
C	0.073	1.85	0.065	1.65	0.058	1.48	0.044	1.12	0.030	0.76

Explanation of Terms

Rated DC Voltage ($V_{M(DC)}$)

This is the maximum continuous DC voltage which may be applied up to the maximum operating temperature of the device. The rated DC operating voltage (working voltage) is also used as the reference point for leakage current. This voltage is always less than the breakdown voltage of the device.

Rated AC Voltage ($V_{M(AC)(RMS)}$)

This is the maximum continuous sinusoidal RMS voltage which may be applied. This voltage may be applied at any temperature up to the maximum operating temperature of the device.

Maximum Non-Repetitive Surge Current (I_{TM})

This is the maximum peak current which may be applied for an 8/20 μ s impulse, with rated voltage also applied, without causing device failure. The pulse can be applied in either polarity with the same confidence factor. See Figure 2 for waveform description.

Maximum Non-Repetitive Surge Energy (W_{TM})

This is the maximum rated transient energy which may be dissipated for a single current impulse at a specified impulse duration (10/1000 μ s), with rated DC or RMS voltage applied, without causing device failure.

Leakage (I_L) at Rated Voltage

In the non-conducting mode, the device is at a very high impedance ($>10^6\Omega$) and appears essentially as an open circuit in the system. The leakage current drawn at this level is very low. See device ratings.

Nominal Voltage ($V_{N(DC)}$)

This is the voltage at which the device changes from the off state to the on state and enters its conduction mode of operation. The voltage is usually characterized at the 1mA point and has a specified minimum and maximum voltage listed.

Clamping Voltage (V_C)

This is the voltage appearing across the suppressor when measured at conditions of specified pulse current and specified waveform. See Device Ratings.

Capacitance (C)

This is the capacitance of the device at the specified frequency (1MHz) and bias (1Vp-p). See Device Ratings.

ML Series

Mechanical Dimensions

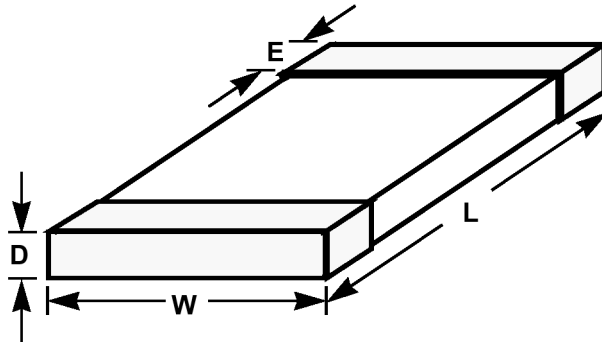

DIMENSION	CHIP SIZE									
	1210		1206		0805		0603		0402	
	Inch	mm	Inch	mm	Inch	mm	Inch	mm	Inch	mm
D Max.	0.113	2.87	0.071	1.80	0.043	1.10	0.035	0.90	0.024	0.60
E	0.02±0.01	0.50±0.25	0.02±0.01	0.50±0.25	0.01±0.029	0.50±0.25	0.015±0.008	0.4±0.2	0.010 ± 0.006	0.25 ± 0.15
L	0.125±0.012	3.20±0.30	0.125±0.012	3.20±0.30	0.079±0.008	2.01±0.20	0.063±0.006	1.6±0.15	0.039 ± 0.004	1.0 ± 0.1
W	0.10±0.012	2.54±0.30	0.06±0.011	1.60±0.28	0.049±0.008	1.25±0.20	0.032±0.06	0.8±0.15	0.020 ± 0.004	0.5 ± 0.1

Ordering Information

VxxML TYPES

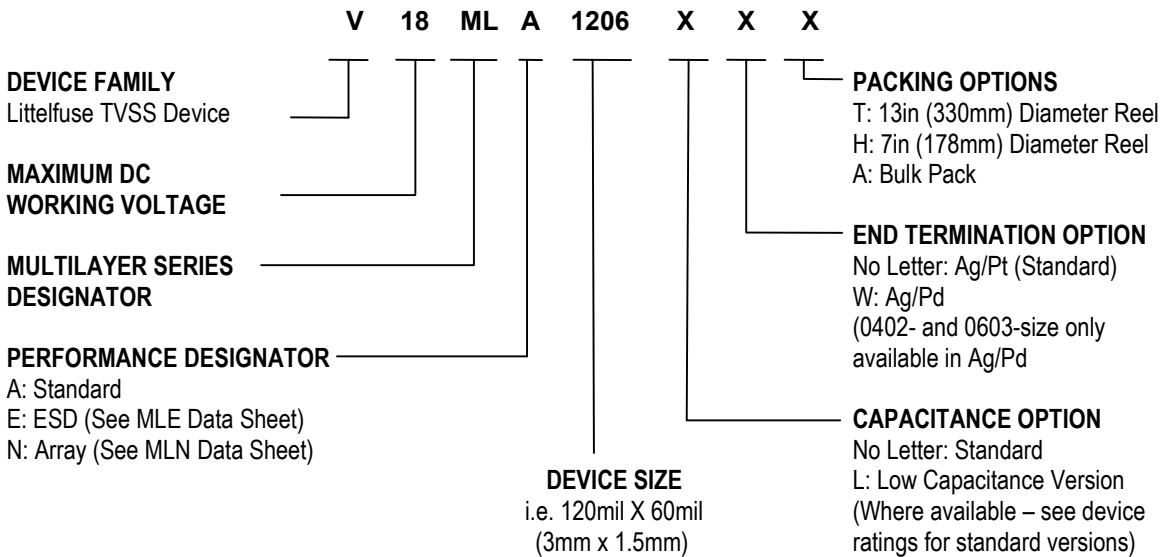

Standard Shipping Quantities

DEVICE SIZE	13 INCH REEL ("T" OPTION)	7 INCH REEL ("H" OPTION)	BULK PACK ("A" OPTION)
1210	8,000	2,500	2,500
1206	10,000	2,500	2,500
0805	10,000	2,500	2,500
0603	10,000	2,500	2,500
0402	N/A	10,000	N/A

ML Series

Tape and Reel Specifications

- Conforms to EIA-481-1, Revision A
- Can be supplied to IEC publication 286-3

SYMBOL	DESCRIPTION	DIMENSIONS IN MILLIMETERS	
		0402-Size	0603- 0805- 1206- & 1210-Sizes
A ₀	Width Of Cavity	Dependent On Chip Size To Minimize Rotation	
B ₀	Length Of Cavity	Dependent On Chip Size To Minimize Rotation	
K ₀	Depth Of Cavity	Dependent On Chip Size To Minimize Rotation	
W	Width Of Tape	8 ±0.2	
F	Distance Between Drive Hole Centers And Cavity Centers	3.5 ±0.05	
E	Distance Between Drive Hole Centers And Tape Edge	1.75 ±0.1	
P ₁	Distance Between Cavity Centers	2 ±0.05	4 ±0.1
P ₂	Axial Drive Distance Between Drive Hole Centers And Cavity Centers	2 ±0.1	
P ₀	Axial Drive Distance Between Drive Hole Centers	4 ±0.1	
D ₀	Drive Hole Diameter	1.55 ±0.05	
D ₁	Diameter Of Cavity Piercing	N/A	1.05 ±0.05
T ₁	Top Tape Thickness	0.1 Max.	

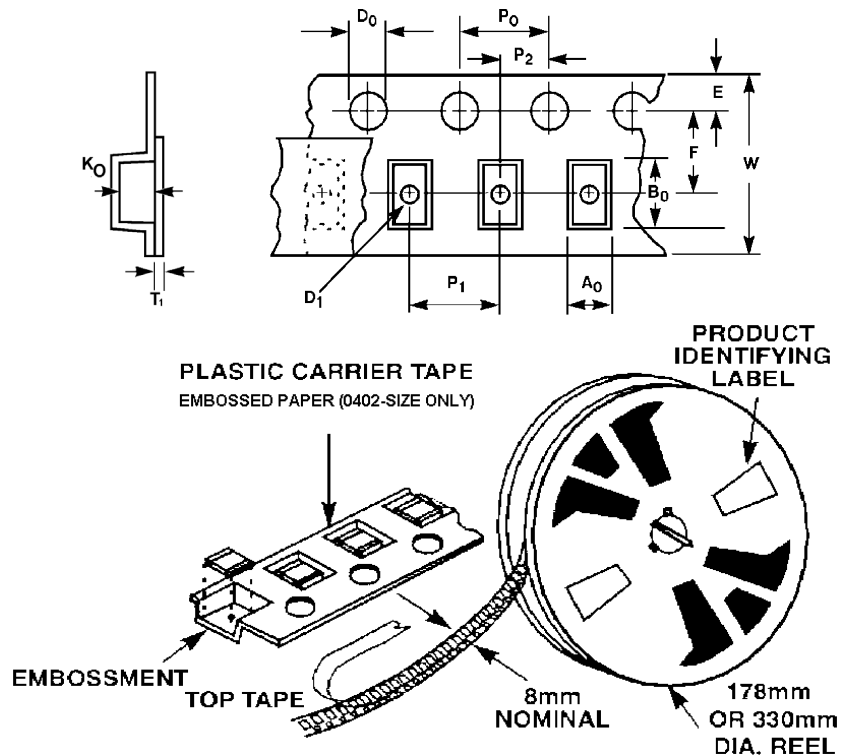

All Littelfuse products are manufactured, assembled and tested under ISO9000 quality systems certification.

Littelfuse products are sold by description only. Littelfuse reserves the right to make changes in specification at any time without notice. Accordingly, the reader is cautioned to verify that data sheets are current before placing orders. Information furnished by Littelfuse is believed to be accurate and reliable. However no responsibility is assumed by Littelfuse or its subsidiaries for its use, or for any infringements of patents or patent rights of third parties which may result from its use. No license is granted by implication or otherwise under any patent or patent rights of Littelfuse Inc. or its subsidiaries.