

MRV Communications, Inc.

**MARV_{EL} SERIES 7L12
OC-12
SINGLEMODE TRANSMITTER**

THE SOURCE FOR YOUR SOURCE

FEATURES

- 1300/1550 NM Wavelength
- For Singlemode Applications
- Data Rate upto 622 Mb/s
- Sonet Compatible
- Low power consumption
- Standard +5V or -5V Power Supply
- 20 Pin Dip Package with FC,ST or Pigtail
- Standard ECL Interface

TRANSMITTER CHARACTERISTICS (T= -40°C TO +85°C)

Parameter	Symbol	Minimum	Typical	Maximum	Unit
Wavelength	λ	1273	1310	1355	nm
Spectral Width	$\Delta\lambda$			2.5	nm
Output Power (Average)	P_0	SEE CHART BELOW			
Wavelength	λ	1480	1550	1580	nm
Spectral Width	$\Delta\lambda$			NA	nm
Output Power (Average)	P_0	SEE CHART BELOW			
Transmit Disable Voltage	Vd	Vcc-2.0		Vcc	V
Extinction Ratio		8			dB
Supply Voltage	Vcc-Vee	4.75	5.0	5.5	V
Supply Current	lee		70	140	mA
Input Data Voltage-High	V _{IH}	Vcc-1.18		Vcc-0.75	V
Input Data Voltage-Low	V _{IL}	Vcc-1.94		Vcc-1.5	V
Laser Bias Monitor Voltage		0.001		0.95	V
Back Facet Monitor Voltage		0.015		0.7	V
Eye Diagram	Per CCITT G.957				

NOTE: All Parameters are specified at OC-12

AVERAGE OUTPUT POWER (T= -40°C to +85°C, 50% DUTY CYCLE)

Part Number 1300 nm Singlemode	Min	Typ	Max	Unit	Part Number 1550 nm Singlemode	Min	Typ	Max	Unit
MRTLxx0003(IR)	.03	.05	.16	mW	MRTLXX50003(IR)	.03	.05	.16	mW
MRTLXX001	0.1	0.2	0.4	mW	MRTLxx5001	0.1	0.2	0.4	mW
MRTLXX003	0.3	0.5	1.0	mW	MRTLXX5003	0.3	0.5	1.0	mW
MRTLXX005(LR)	0.5	1.0	1.6	mW	MRTLXX5005(LR)	0.5	1.0	1.6	mW
MRTLXX010	1.0	1.5	2.0	mW					

XX = SP- Singlemode Pigtail, ST- Singlemode ST, FC- Singlemode FC,

ABSOLUTE MAXIMUM RATINGS

PARAMETER	SYMBOL	RATING	UNIT
Supply Voltage	Vcc-Vee	6.0	VOLTS
Lead Soldering Temp		260	°C
Lead Soldering Time		10	SECONDS
Operating Temp		-40 to +85	°C
Storage Temp		-40 to +85	°C

Pinout Diagram

Top View

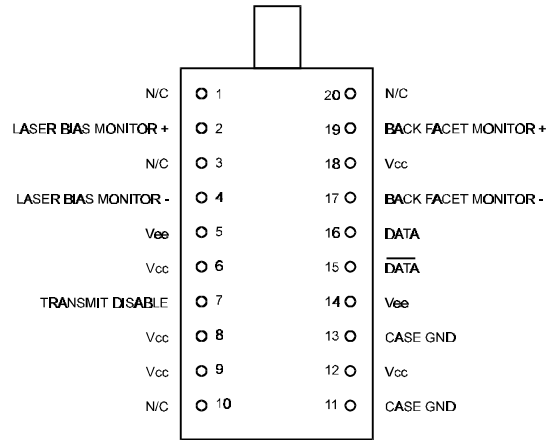

Application Circuit

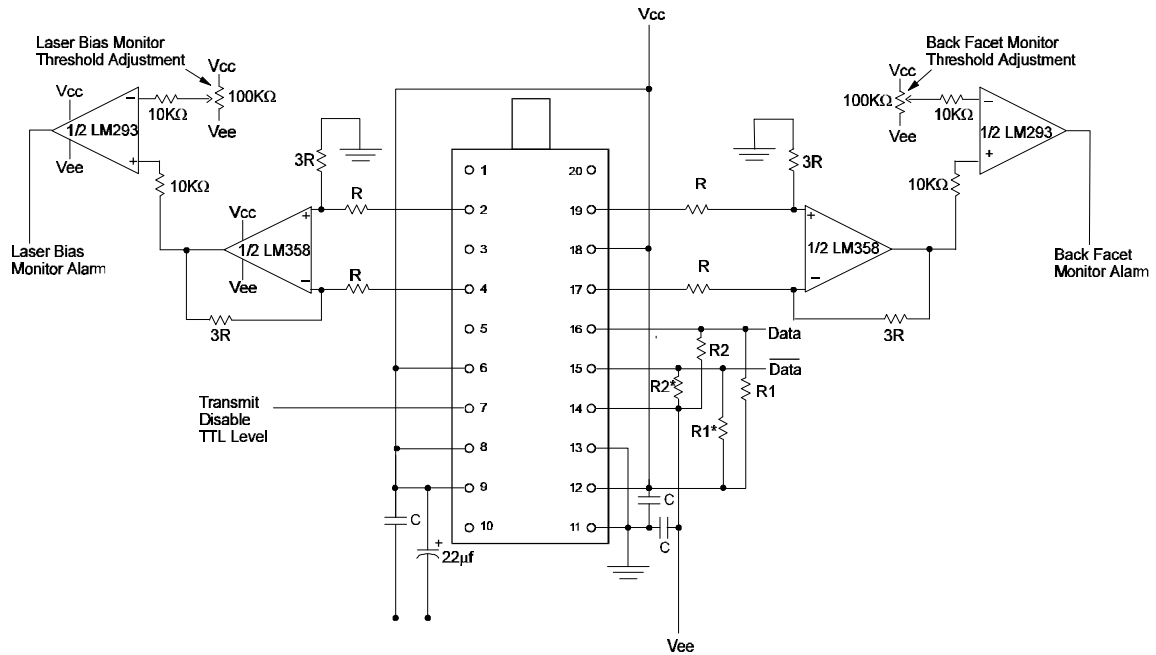

$R = 10K\Omega, R1 = R1^* = 1.6 Z_0, R2 = R2^* = 2.6 Z_0, (\text{ For Short Line } Z_0 = 50\Omega) C = 0.1\mu F$

Package Style "ST"

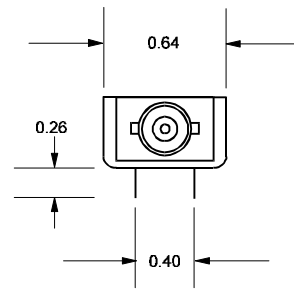
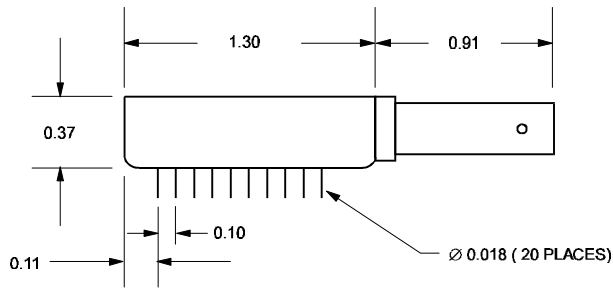

Package Style "FC"

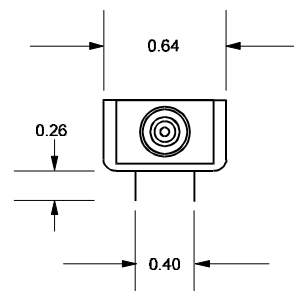
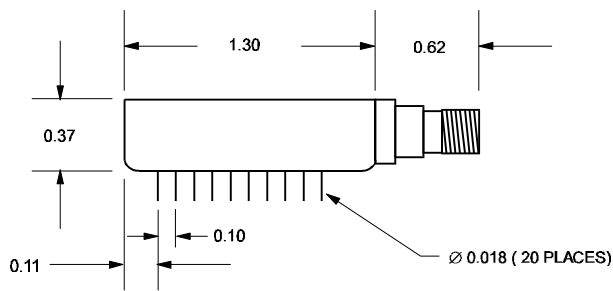

Package Style "SP"

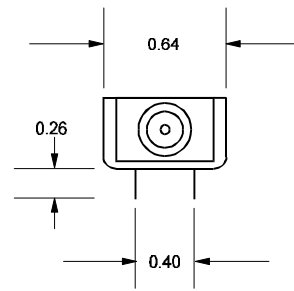
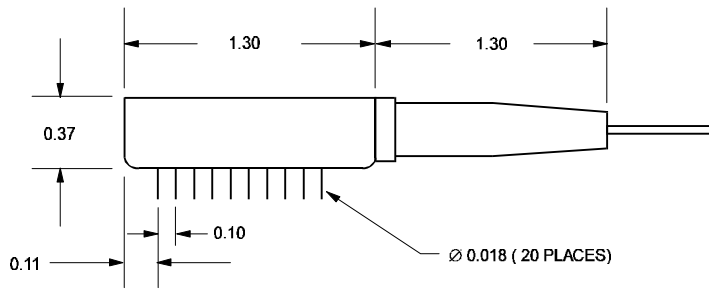

Package Style "SC"

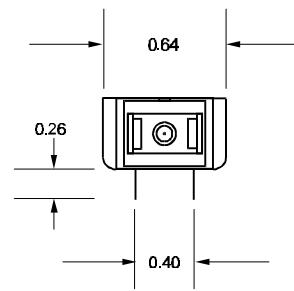
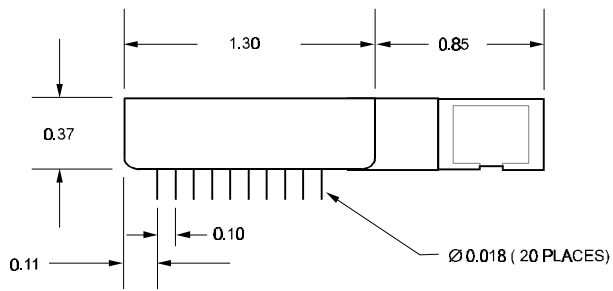

Ordering Information

Part Number(1310nm)	Termination	Temperature Rating
MRTLSPxxx-7L12-A	None	0°C to +65°C
MRTLSPxxx-7L12-B	None	-40°C to +85°C
MRTLSPxxx-7L12-C	ST	0°C to +65°C
MRTLSPxxx-7L12-D	ST	-40°C to +85°C
MRTLSPxxx-7L12-E	FC	0°C to +65°C
MRTLSPxxx-7L12-F	FC	-40°C to +85°C
MRTLSPxxx-7L12-G	SC	0°C to +65°C
MRTLSPxxx-7L12-H	SC	-40°C to +85°C
MRTLSTxxx-7L12-I	None	0°C to +65°C
MRTLSTxxx-7L12-J	None	-40°C to +85°C
MRTLFCxxx-7L12-K	None	0°C to +65°C
MRTLFCxxx-7L12-L	None	-40°C to +85°C
MRTLSPxxx-7L12-M	DIN	0°C to +65°C
MRTLSPxxx-7L12-N	DIN	-40°C to +85°C
MRTLSCxxx-7L12-O	None	0°C to +65°C
MRTLSCxxx-7L12-P	None	-40°C to +85°C

Part Number(1550nm)	Termination	Temperature Rating
MRTLSP5xxx-7L12-A	None	0°C to +65°C
MRTLSP5xxx-7L12-B	None	-40°C to +85°C
MRTLSP5xxx-7L12-C	ST	0°C to +65°C
MRTLSP5xxx-7L12-D	ST	-40°C to +85°C
MRTLSP5xxx-7L12-E	FC	0°C to +65°C
MRTLSP5xxx-7L12-F	FC	-40°C to +85°C
MRTLSP5xxx-7L12-G	SC	0°C to +65°C
MRTLSP5xxx-7L12-H	SC	-40°C to +85°C
MRTLST5xxx-7L12-I	None	0°C to +65°C
MRTLST5xxx-7L12-J	None	-40°C to +85°C
MRTLFC5xxx-7L12-K	None	0°C to +65°C
MRTLFC5xxx-7L12-L	None	-40°C to +85°C
MRTLSP5xxx-7L12-M	DIN	0°C to +65°C
MRTLSP5xxx-7L12-N	DIN	-40°C to +85°C
MRTLSC5xxx-7L12-O	None	0°C to +65°C
MRTLSC5xxx-7L12-P	None	-40°C to +85°C

xxx = Output Power from Chart

CLASS 1 DEVICE. THIS PRODUCT CONFORMS TO APPLICABLE REQUIREMENTS OF 21 CFR 1040 AT THE DATE OF MANUFACTURE(CDRH). THIS PRODUCT ALSO MEETS THE REQUIREMENTS OF EN 60950 AND EN 60825 (TUV). APPLICABLE TO DEVICES WITH MAXIMUM OUTPUT POWER OF 1MW.