

### THYRISTOR / DIODE and THYRISTOR / THYRISTOR

### SUPER MAGN-A-pak™ Power Modules

#### Features

- High current capability
- 3000 V<sub>RMS</sub> isolating voltage with non-toxic substrate
- High surge capability
- Industrial standard package
- UL E78996 approved 

500 A

#### Typical Applications

- Motor starters
- DC motor controls - AC motor controls
- Uninterruptable power supplies

#### Major Ratings and Characteristics

Parameters	IRK.500..	Units
$I_{T(AV)}$ or $I_{F(AV)}$	500	A
@ $T_C$	82	°C
$I_{T(RMS)}$	785	A
@ $T_C$	82	°C
$I_{TSM}$ or $I_{FSM}$ @ 50Hz	17.8	KA
@ 60Hz	18.7	KA
$I^2t$ @ 50Hz	1591	KA <sup>2</sup> s
@ 60Hz	1452	KA <sup>2</sup> s
$I^2\sqrt{t}$	15910	KA <sup>2</sup> √s
$V_{DRM}/V_{RRM}$ range	800 to 1600	V
$T_{STG}$ range	-40 to 150	°C
$T_J$ range	-40 to 130	°C

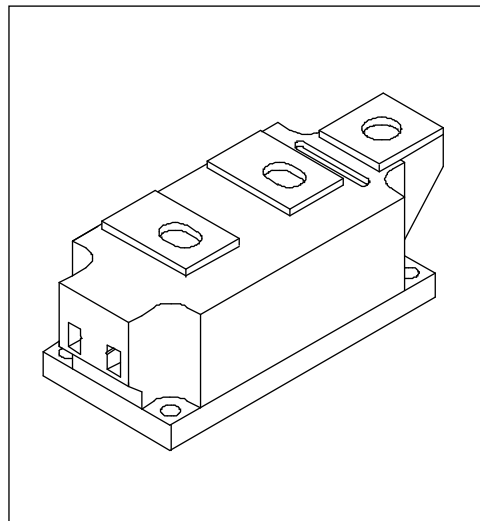

**ELECTRICAL SPECIFICATIONS**

**Voltage Ratings**

Type number	Voltage Code	$V_{RRM}/V_{DRM}$ maximum repetitive peak reverse voltage V	$V_{RSM}$ , maximum non-repetitive peak rev. voltage V	$I_{RRM}/I_{DRM}$ max. @ $T_J = T_J$ max. mA
IRK.500..	08	800	900	100
	12	1200	1300	
	14	1400	1500	
	16	1600	1700	

**On-state Conduction**

Parameter	IRK.500..	Units	Conditions
$I_{T(AV)}$ Maximum average on-state current $I_{F(AV)}$ @ Case temperature	500 82	A °C	180° conduction, half sine wave
$I_{T(RMS)}$ Maximum RMS on-state current	785	A	180° conduction, half sine wave @ $T_C = 82^\circ\text{C}$
$I_{TSM}$ Maximum peak, one-cycle, $I_{FSM}$ non-repetitive surge current	17.8	KA	t = 10ms No voltage
	18.7		t = 8.3ms reappplied
	15.0		t = 10ms 100% $V_{RRM}$
	15.7		t = 8.3ms reappplied
$I^2t$ Maximum $I^2t$ for fusing	1591	KA <sup>2</sup> s	t = 10ms No voltage
	1452		t = 8.3ms reappplied
	1125		t = 10ms 100% $V_{RRM}$
	1027		t = 8.3ms reappplied
$I^2\sqrt{t}$ Maximum $I^2\sqrt{t}$ for fusing	15910	KA <sup>2</sup> /s	t = 0.1 to 10ms, no voltage reappplied
$V_{T(TO)1}$ Low level value of threshold voltage	0.85	V	$(16.7\% \times \pi \times I_{T(AV)} < I < \pi \times I_{T(AV)})$ , $T_J = T_J$ max.
$V_{T(TO)2}$ High level value of threshold voltage	0.93		$(I > \pi \times I_{T(AV)})$ , $T_J = T_J$ max.
$r_{t1}$ Low level value of on-state slope resistance	0.36	mΩ	$(16.7\% \times \pi \times I_{T(AV)} < I < \pi \times I_{T(AV)})$ , $T_J = T_J$ max.
$r_{t2}$ High level value of on-state slope resistance	0.32		$(I > \pi \times I_{T(AV)})$ , $T_J = T_J$ max.
$V_{TM}$ Maximum on-state or forward $V_{FM}$ voltage drop	1.50	V	$I_{pk} = 1500\text{A}$ , $T_J = 25^\circ\text{C}$ , $t_p = 10\text{ms}$ sine pulse
$I_H$ Maximum holding current	500	mA	$T_J = 25^\circ\text{C}$ , anode supply 12V resistive load
$I_L$ Typical latching current	1000		

**Switching**

Parameter	IRK.500..	Units	Conditions
di/dt Maximum rate of rise of turned-on current	1000	A/μs	$T_J = T_J$ max., $I_{TM} = 400\text{A}$ , $V_{DRM}$ applied
$t_d$ Typical delay time	2.0	μs	Gate current 1A, $di_g/dt = 1\text{A}/\mu\text{s}$ $V_d = 0.67\% V_{DRM}$ , $T_J = 25^\circ\text{C}$
$t_q$ Typical turn-off time	200	μs	$I_{TM} = 750\text{A}$ , $T_J = T_J$ max, $di/dt = -60\text{A}/\mu\text{s}$ , $V_R = 50\text{V}$ , $dv/dt = 20\text{V}/\mu\text{s}$ , Gate 0 V 100Ω

### Blocking

Parameter	IRK.500..	Units	Conditions
dv/dt Maximum critical rate of rise of off-state voltage	1000	V/ $\mu$ s	$T_J = 130^\circ\text{C}$ ., linear to $V_D = 80\% V_{DRM}$
$V_{INS}$ RMS isolation voltage	3000	V	$t = 1 \text{ s}$
$I_{RRM}$ Maximum peak reverse and off-state leakage current $I_{DRM}$	100	mA	$T_J = T_J \text{ max.}$ ., rated $V_{DRM}/V_{RRM}$ applied

### Triggering

Parameter	IRK.500..	Units	Conditions
$P_{GM}$ Maximum peak gate power	10	W	$T_J = T_J \text{ max.}$ ., $t_p \leq 5 \text{ ms}$
$P_{G(AV)}$ Maximum peak average gate power	2.0	W	$T_J = T_J \text{ max.}$ ., $f = 50 \text{ Hz}$ , $d\% = 50$
$+I_{GM}$ Maximum peak positive gate current	3.0	A	$T_J = T_J \text{ max.}$ ., $t_p \leq 5 \text{ ms}$
$+V_{GM}$ Maximum peak positive gate voltage	20	V	
$-V_{GM}$ Maximum peak negative gate voltage	5.0	V	
$I_{GT}$ Max. DC gate current required to trigger	200	mA	$T_J = 25^\circ\text{C}$ $V_{ak} 12 \text{ V}$
$V_{GT}$ DC gate voltage required to trigger	3.0	V	$T_J = 25^\circ\text{C}$ $V_{ak} 12 \text{ V}$
$I_{GD}$ DC gate current not to trigger	10	mA	$T_J = T_J \text{ max.}$
$V_{GD}$ DC gate voltage not to trigger	0.25	V	

### Thermal and Mechanical Specifications

Parameter	IRK.500..	Units	Conditions
$T_J$ Max. junction operating temperature range	- 40 to 130	°C	
$T_{stg}$ Max. storage temperature range	- 40 to 150		
$R_{thJC}$ Max. thermal resistance, junction to case	0.065	K/W	Per junction, DC operation
$R_{thC-hs}$ Max. thermal resistance, case to heatsink	0.02	K/W	
T Mounting torque $\pm 10\%$ SMAP to heatsink busbar to SMAP	6 - 8	Nm	A mounting compound is recommended and the torque should be rechecked after a period of 3 hours to allow for the spread of the compound
	12 - 15		
wt Approximate weight	1500	g	
Case style	SUPER MAGN-A-pak		See outline table

## IRK.500.. Series

Bulletin I27401 rev. A 09/97

International  
**IRF** Rectifier

### $\Delta R_{thJC}$ Conduction

(The following table shows the increment of thermal resistance  $R_{thJC}$  when devices operate at different conduction angles than DC)

Conduction angle	Sinusoidal conduction	Rectangular conduction	Units	Conditions
180°	0.009	0.006	K/W	$T_J = T_{J \text{ max.}}$
120°	0.011	0.011		
90°	0.014	0.015		
60°	0.021	0.022		
30°	0.037	0.038		

### Ordering Information Table

Device Code				
1	2	3	4	
IRK	T	500	-	16
<b>1</b>	- Module type			
<b>2</b>	- Circuit configuration (See Circuit Configurations Table)			
<b>3</b>	- Current rating			
<b>4</b>	- Voltage code: Code x 100 = $V_{RRM}$ (See Voltage Ratings Table)			

### Circuit Configurations Table

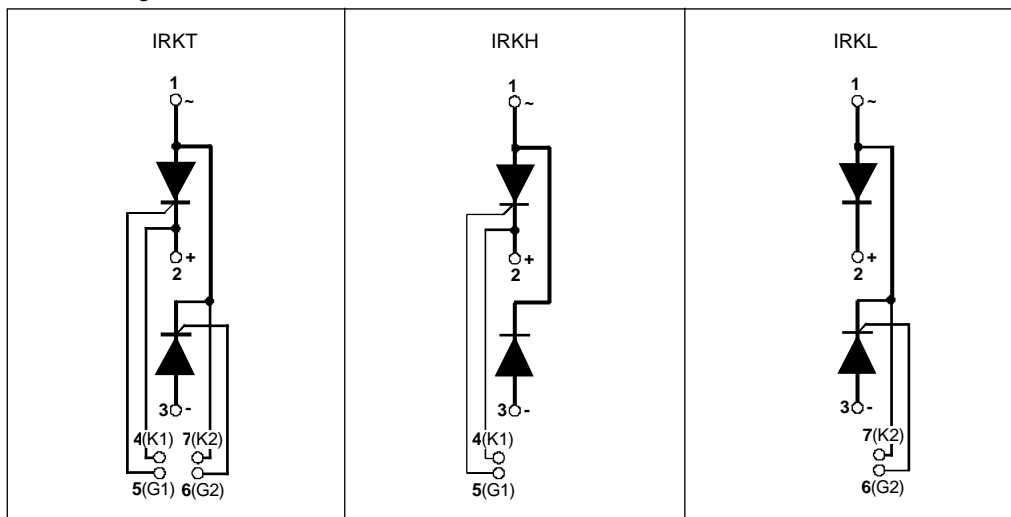

**NOTE: To order the Optional Hardware see Bulletin I27900**

Outline Table

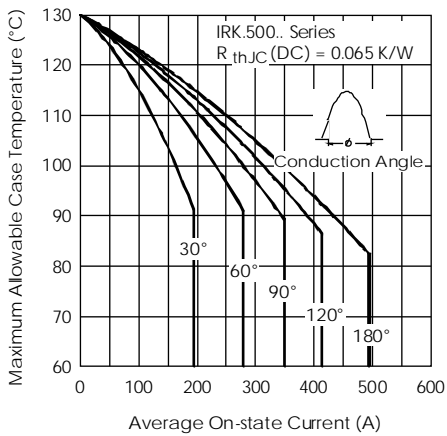
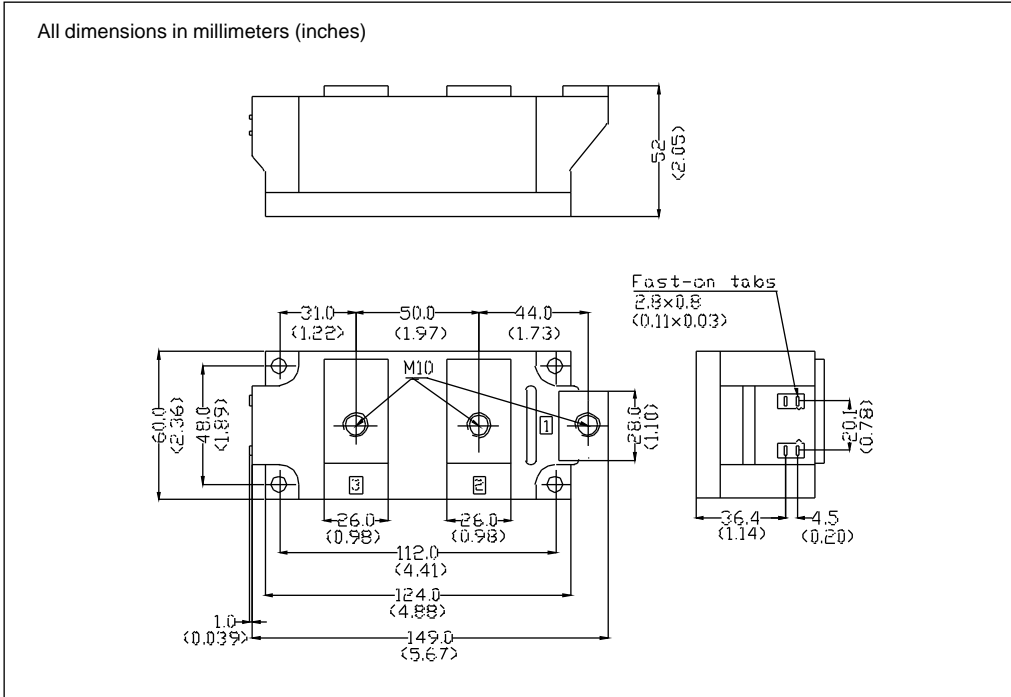

Fig. 1 - Current Ratings Characteristics

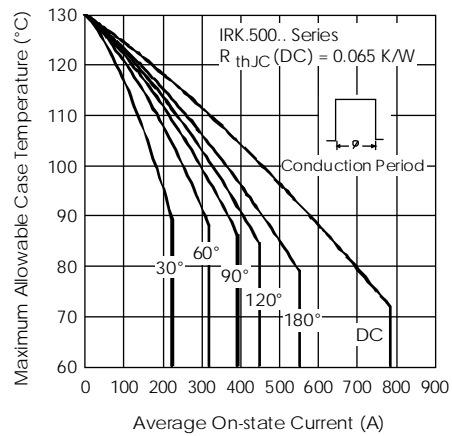

Fig. 2 - Current Ratings Characteristics

**IRK.500.. Series**

Bulletin I27401 rev. A 09/97

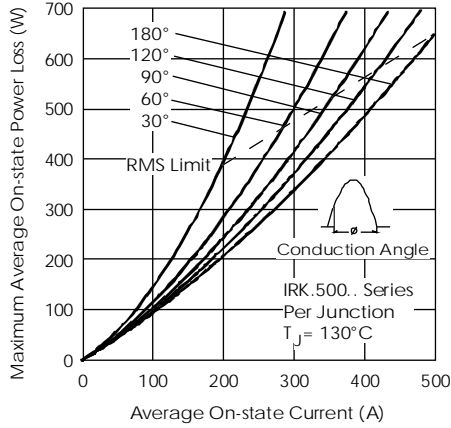

Fig. 3 - On-state Power Loss Characteristics

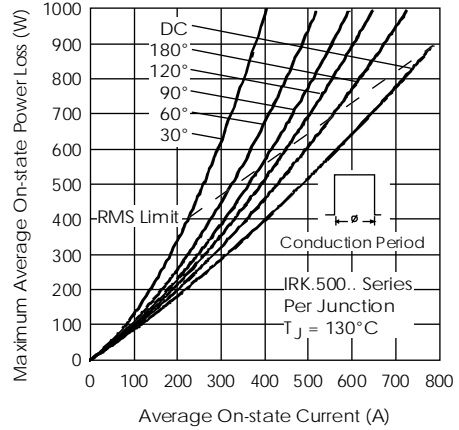

Fig. 4 - On-state Power Loss Characteristics

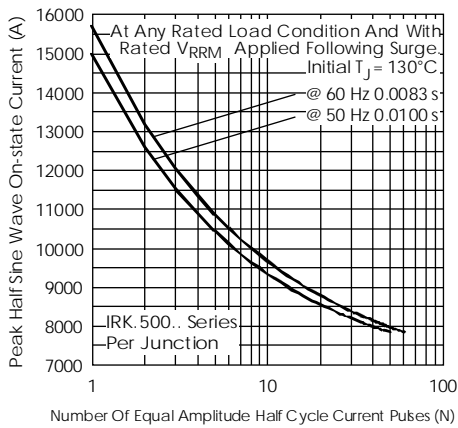

Fig. 5 - Maximum Non-Repetitive Surge Current

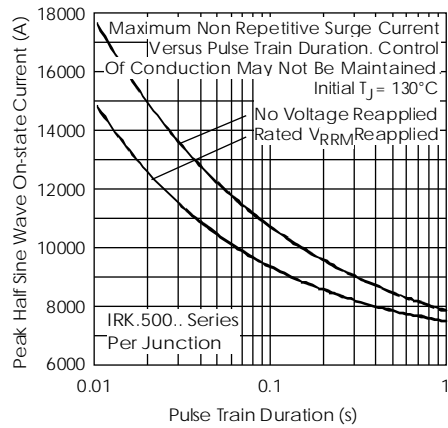

Fig. 6 - Maximum Non-Repetitive Surge Current

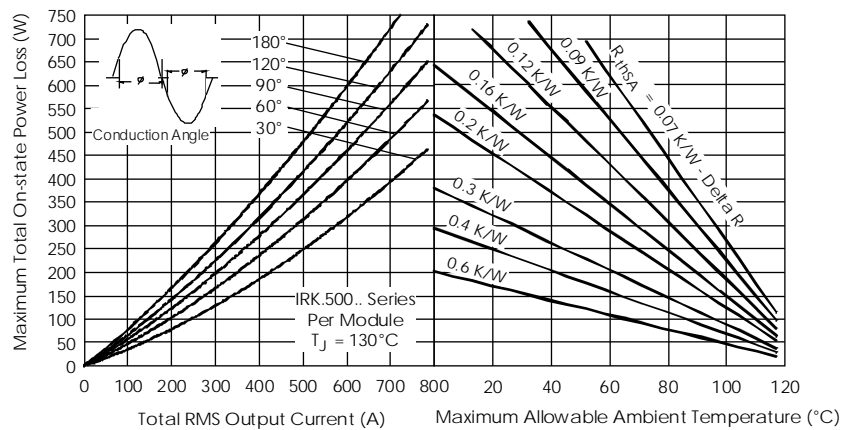

Fig. 7 - On-state Power Loss Characteristics

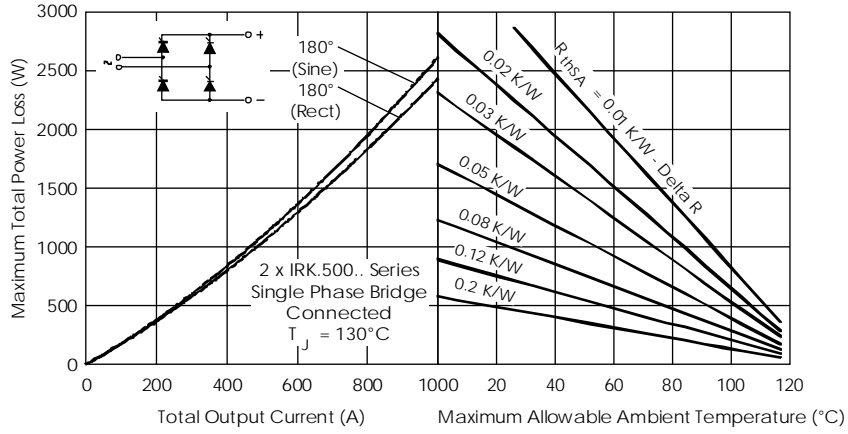

Fig. 8 - On-state Power Loss Characteristics

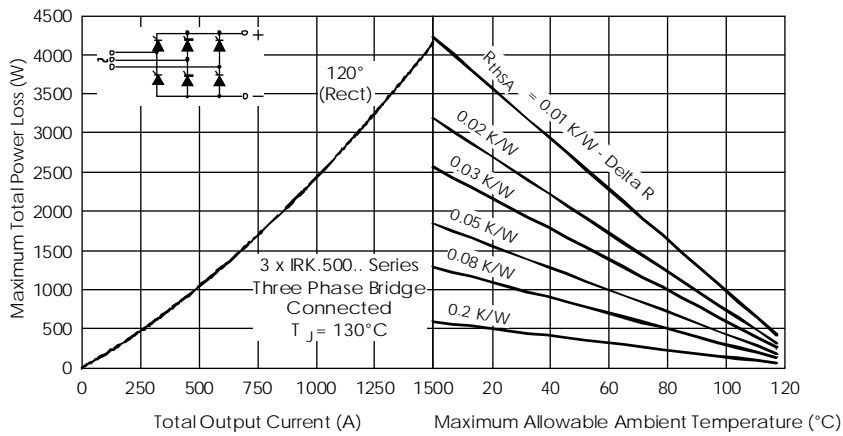

Fig. 9 - On-state Power Loss Characteristics

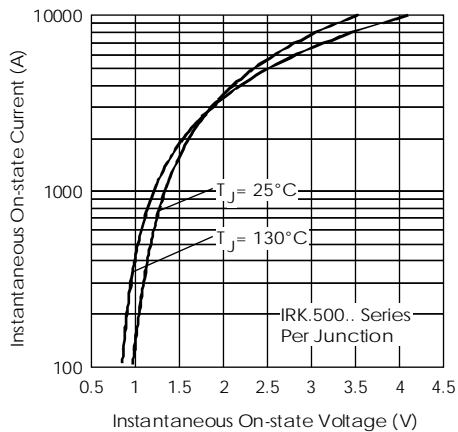

Fig. 10 - On-state Voltage Drop Characteristics

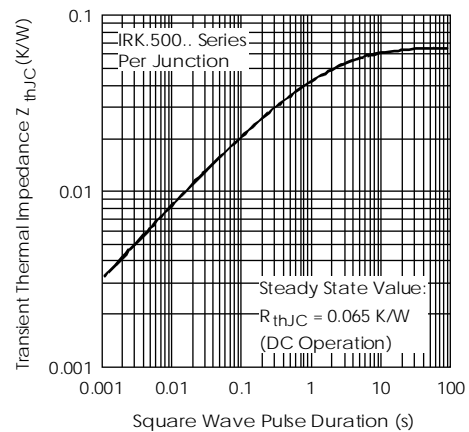

Fig. 11 - Thermal Impedance  $Z_{thJC}$  Characteristics

**IRK.500.. Series**

Bulletin I27401 rev. A 09/97

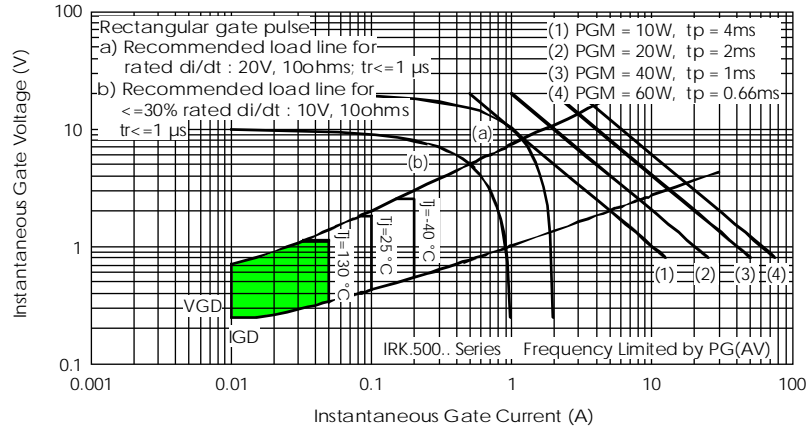

Fig. 12 - Gate Characteristics