



Dual N-/Dual P-Channel 30-V (D-S) MOSFETs

PRODUCT SUMMARY				
	$V_{(BR)DSS}$ Min (V)	$r_{DS(on)}$ Max (Ω)	$V_{GS(th)}$ (V)	I_D (A)
N-Channel	30	1 @ $V_{GS} = 12$ V	0.8 to 2.5	0.85
P-Channel	-30	2 @ $V_{GS} = -12$ V	-2 to -4.5	-0.6

FEATURES

- Low On-Resistance: 0.8/1.6 Ω
- Low Threshold: 1.5/–3.1 V
- Low Input Capacitance: 38/60 pF
- Fast Switching Speed: 9/16 ns
- Low Input and Output Leakage

BENEFITS

- Low Offset Voltage
- Low-Voltage Operation
- Easily Driven Without Buffer
- High-Speed Circuits
- Low Error Voltage

APPLICATIONS

- Direct Logic-Level Interface: TTL/CMOS
- Drivers: Relays, Solenoids, Lamps, Hammers, Displays, Memories, Transistors, etc.
- Battery Operated Systems
- Solid-State Relays

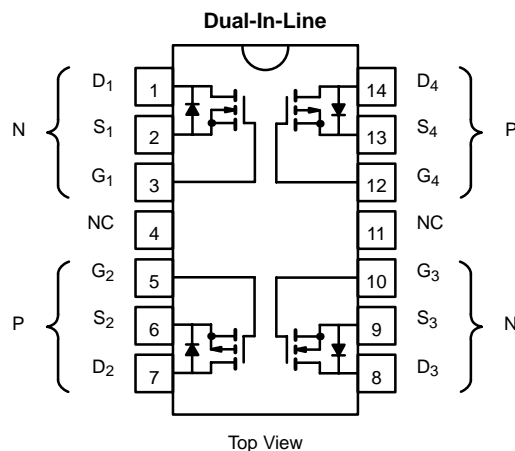

Top View
Plastic: VQ3001J
Sidebrazed: VQ3001P

Device Marking
Top View

VQ3001J
"S" flxxyy

VQ3001P
"S" flxxyy

"S" = Siliconix Logo
f = Factory Code
// = Lot Traceability
xyyy = Date Code

ABSOLUTE MAXIMUM RATINGS ($T_A = 25^\circ\text{C}$ UNLESS OTHERWISE NOTED)						
Parameter	Symbol	Single		Total Quad	Unit	
		N-Channel	P-Channel			
Drain-Source Voltage	V_{DS}	30	30		V	
Gate-Source Voltage	V_{GS}	VQ3001J	± 20		V	
		VQ3001P	± 20			
Continuous Drain Current ($T_J = 150^\circ\text{C}$)	I_D	$T_A = 25^\circ\text{C}$	0.85	-0.6	A	
		$T_A = 100^\circ\text{C}$	0.52	-0.37		
Pulsed Drain Current ^a	I_{DM}	3	-2			
Power Dissipation	P_D	$T_A = 25^\circ\text{C}$	1.3	1.3	2	W
		$T_A = 100^\circ\text{C}$	0.52	0.52	0.8	
Thermal Resistance, Junction-to-Ambient	R_{thJA}	96.2	96.2	62.5	$^\circ\text{C}/\text{W}$	
Operating Junction and Storage Temperature Range	T_J, T_{stg}	-55 to 150		-55 to 150	$^\circ\text{C}$	

Notes

a. Pulse width limited by maximum junction temperature.

SPECIFICATIONS (T _A = 25 °C UNLESS OTHERWISE NOTED)								
Parameter	Symbol	Test Condition	Typ ^a	Limits				Unit
				N-Channel		P-Channel		
				Min	Max	Min	Max	
Static								
Drain-Source Breakdown Voltage	V _{(BR)DSS}	V _{GS} = 0 V, I _D = 10 μA	55	30				V
		V _{GS} = 0 V, I _D = -10 μA	-55			-30		
Gate-Source Threshold Voltage	V _{GS(th)}	V _{DS} = V _{GS} , I _D = 1 mA	1.5	0.8	2.5			
		V _{DS} = V _{GS} , I _D = -1 mA	-3.1			-2	-4.5	
Gate-Body Leakage	I _{GSS}	V _{DS} = 0 V, V _{GS} = ±20 V			±100		±100	nA
		V _{DS} = 0 V, V _{GS} = ±20 V, T _J = 125 °C			±500		±500	
Zero-Gate Voltage Drain Current	I _{DSS}	V _{DS} = 24 V, V _{GS} = 0 V			10			μA
		V _{DS} = -24 V, V _{GS} = 0 V					-10	
		V _{DS} = 24 V, V _{GS} = 0 V, T _J = 125 °C			500			
		V _{DS} = -24 V, V _{GS} = 0 V, T _J = 125 °C					-500	
On-State Drain Current ^b	I _{D(on)}	V _{DS} = 10 V, V _{GS} = 12 V	3	2				A
		V _{DS} = -10 V, V _{GS} = -12 V	-2			-1.5		
Drain-Source On-State Resistance ^b	r _{DS(on)}	V _{GS} = 5 V, I _D = 0.2 A	1.2		1.75			Ω
		V _{GS} = 12 V, I _D = 1 A	0.81		1.0			
		V _{GS} = -12 V, I _D = -1 A	1.6				2.0	
		V _{GS} = 12 V, I _D = 1 A, T _J = 125 °C	1.65		2.0			
		V _{GS} = -12 V, I _D = -1 A, T _J = 125 °C	2.7				4.0	
Forward Transconductance ^b	g _{fs}	V _{DS} = 10 V, I _D = 0.5 A	500	250				mS
		V _{DS} = -10 V, I _D = -0.5 A	390			200		
Dynamic								
Input Capacitance	C _{iss}	N-Channel V _{DS} = 15 V, V _{GS} = 0 V, f = 1 MHz P-Channel V _{DS} = -15 V, V _{GS} = 0 V, f = 1 MHz	38		110			pF
			60				150	
Output Capacitance	C _{oss}		33		110			
			45				100	
Reverse Transfer Capacitance	C _{rss}		8		35			
		15				60		
Turn-On Time	t _{ON}	N-Channel V _{DD} = 15 V, R _L = 23 Ω I _D ≅ 0.6 A, V _{GEN} = 10 V, R _G = 25 Ω P-Channel V _{DD} = -15 V, R _L = 23 Ω I _D ≅ -0.6 A, V _{GEN} = -10 V, R _G = 25 Ω	9		30			ns
			19				30	
Turn-Off Time	t _{OFF}		14		30			
			16				30	

Notes

- a. For DESIGN AID ONLY, not subject to production testing.
- b. Pulse test: PW ≤ 300 μs duty cycle ≤ 2%.

VNDQ03/VPEA03



TYPICAL CHARACTERISTICS ($T_A = 25^\circ\text{C}$ UNLESS OTHERWISE NOTED) N-CHANNEL

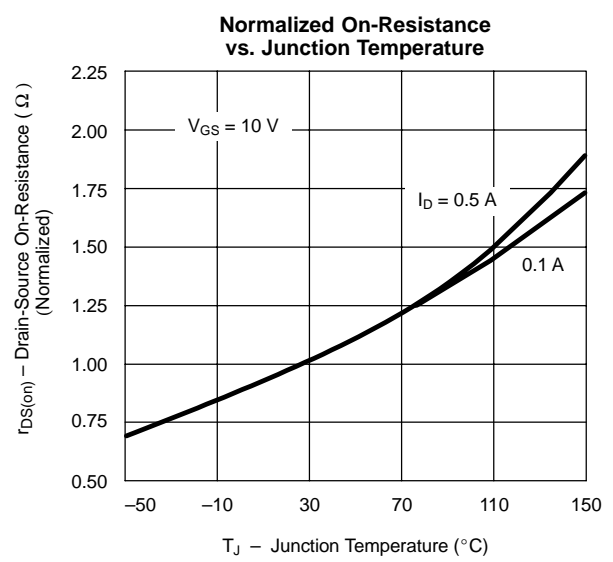
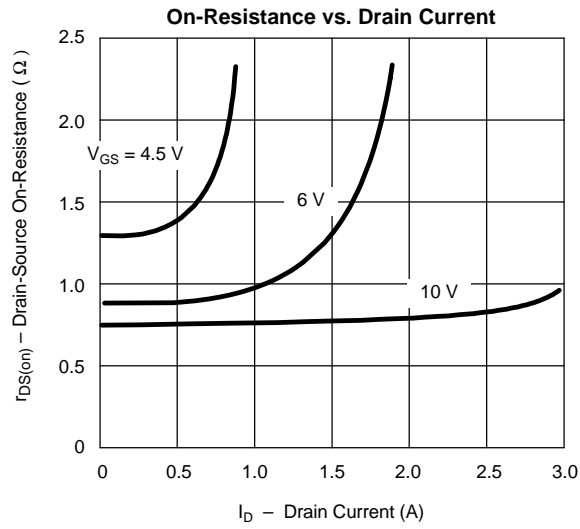
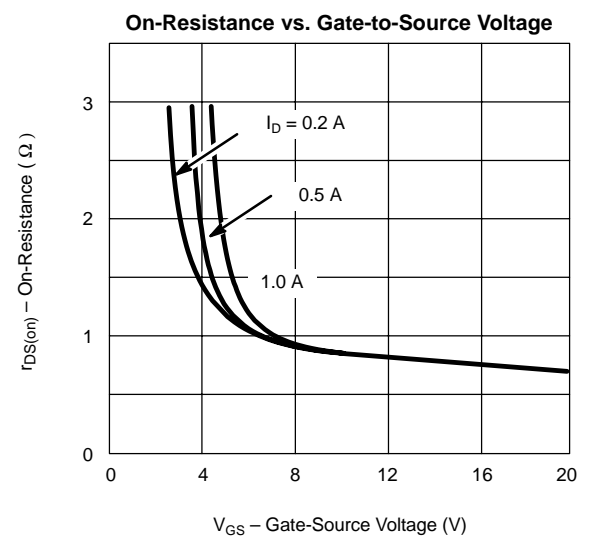
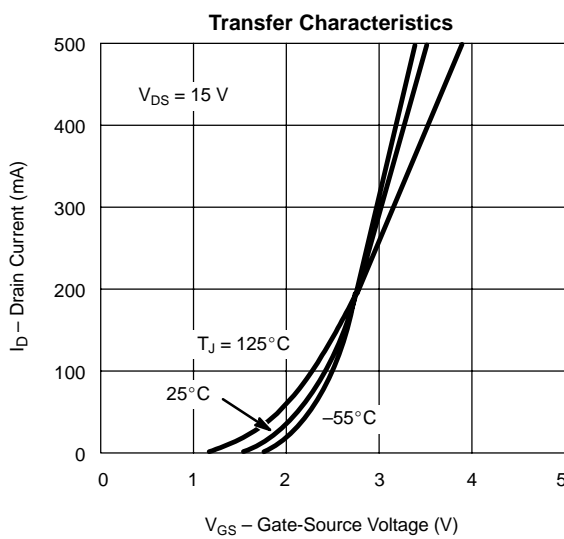
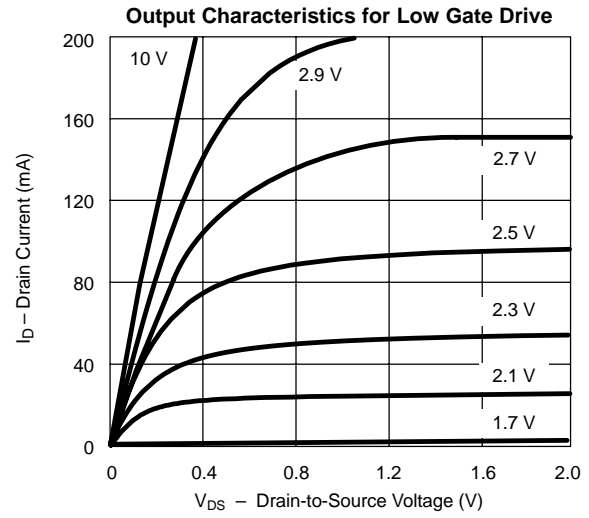
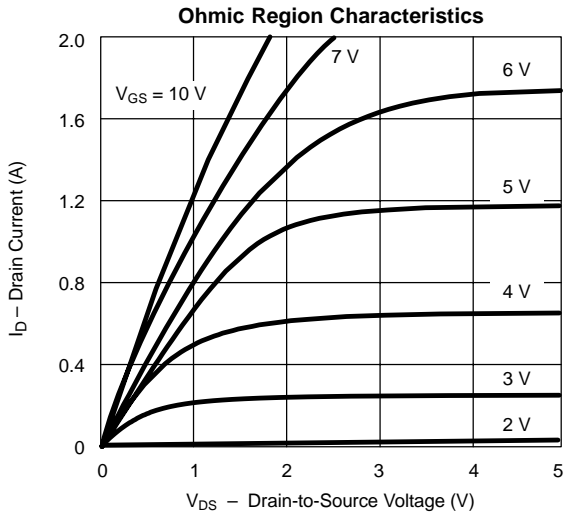

TYPICAL CHARACTERISTICS ($T_A = 25^\circ\text{C}$ UNLESS OTHERWISE NOTED) N-CHANNEL

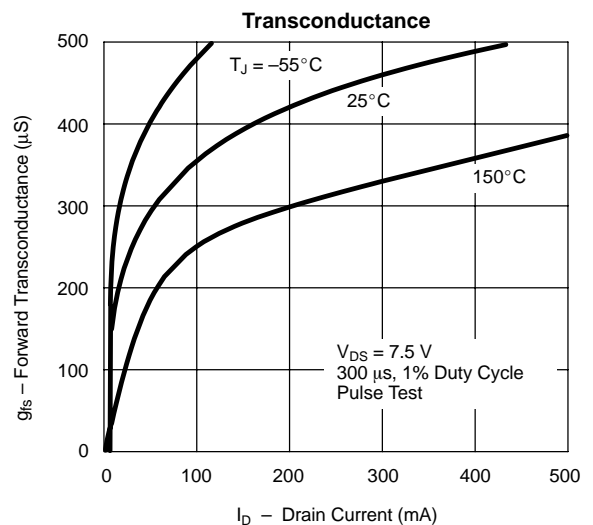
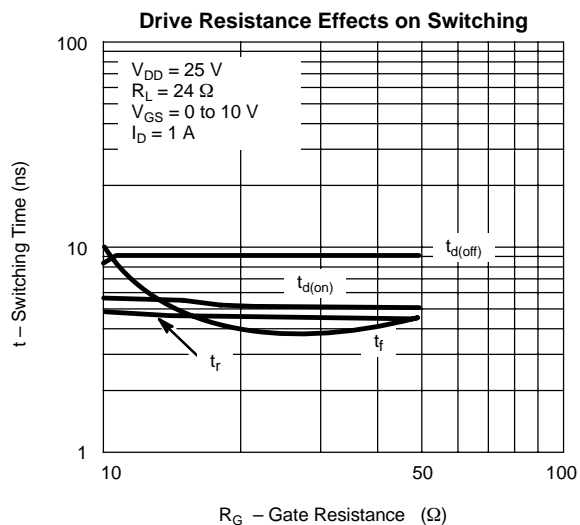
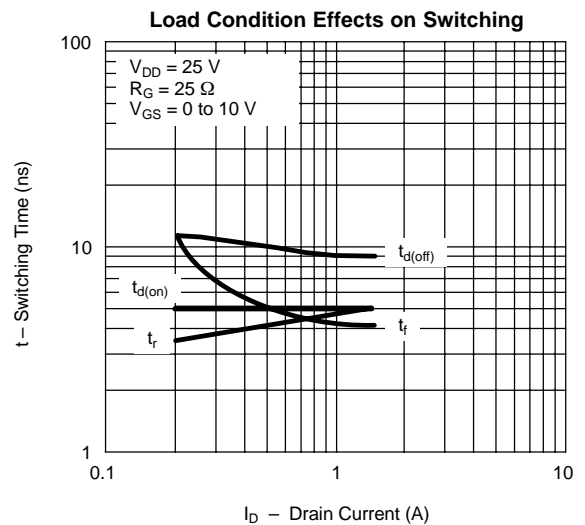
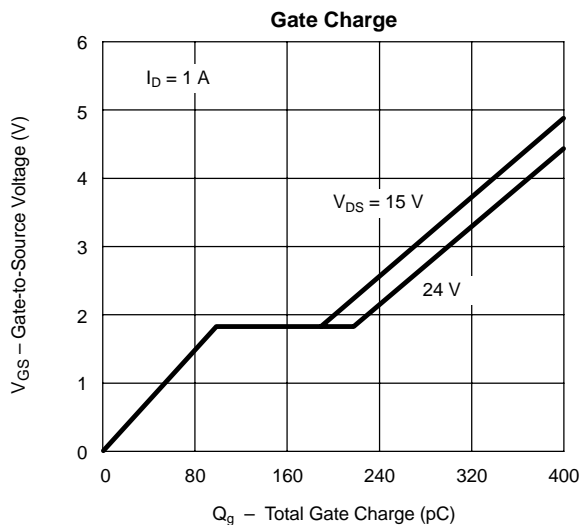
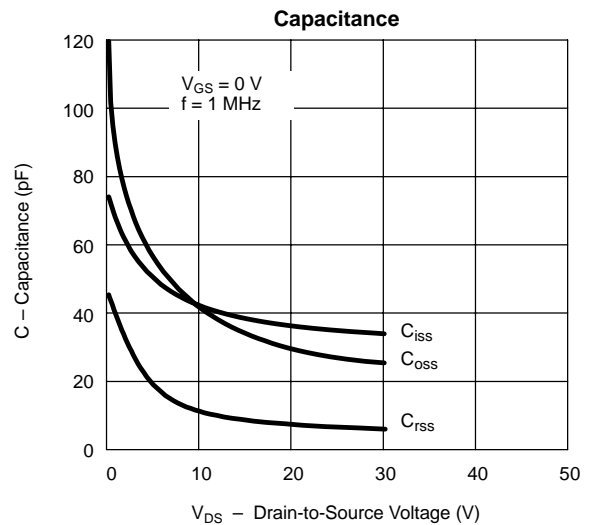
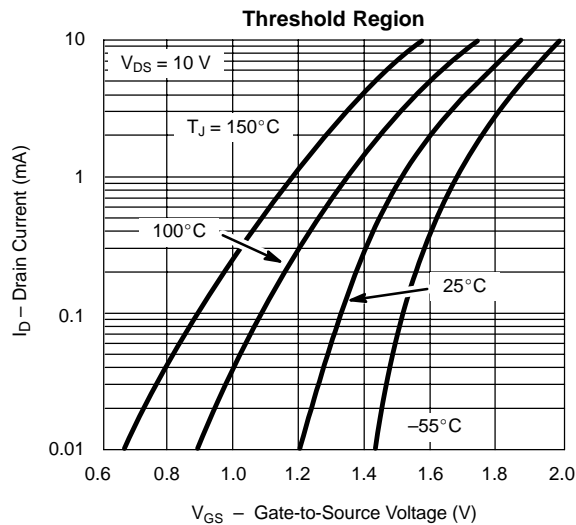



TYPICAL CHARACTERISTICS ($T_A = 25^\circ\text{C}$ UNLESS OTHERWISE NOTED) P-CHANNEL

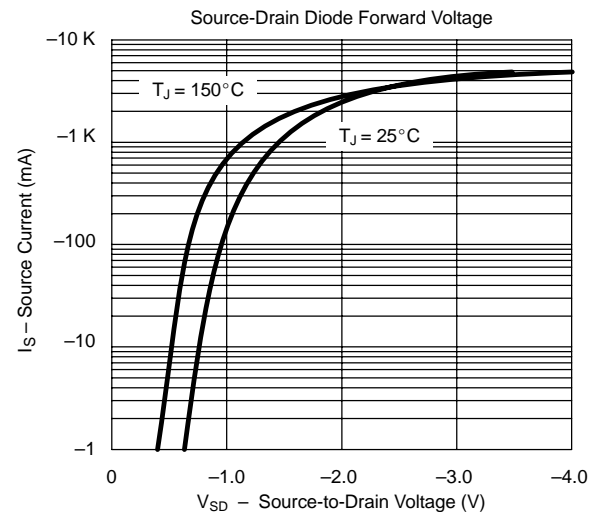
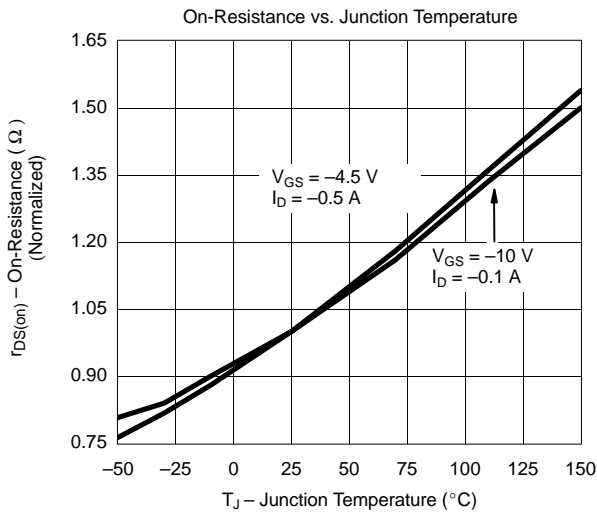
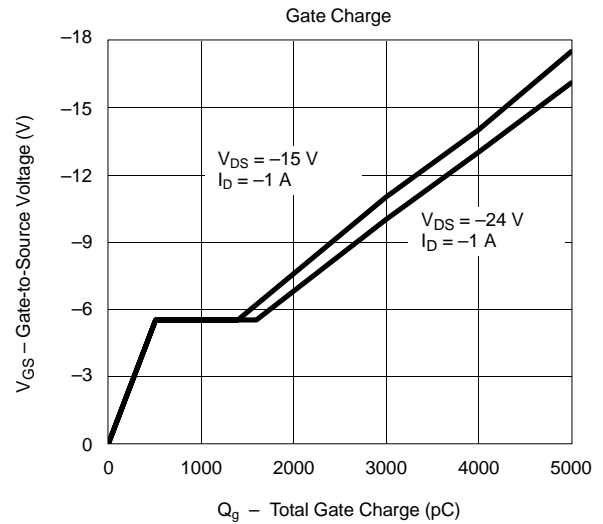
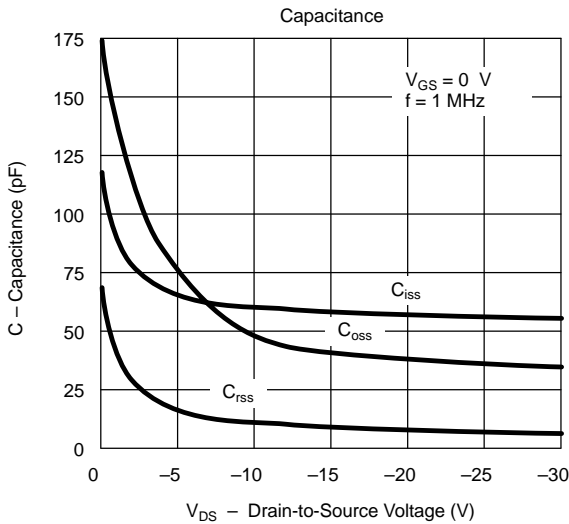
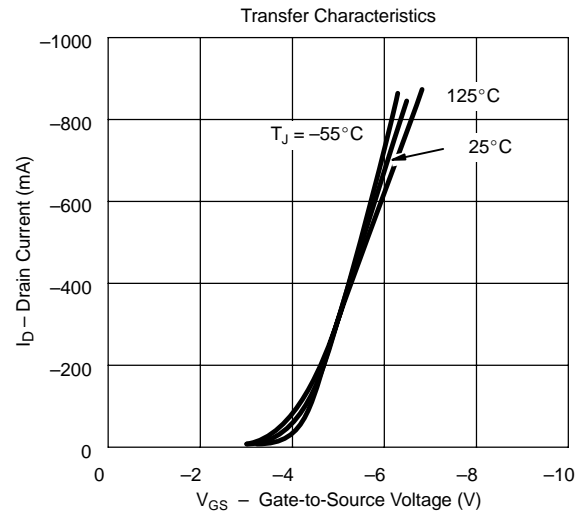
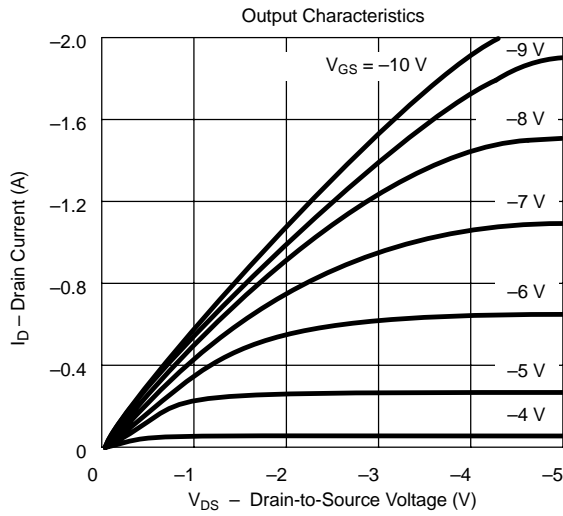

TYPICAL CHARACTERISTICS ($T_A = 25^\circ\text{C}$ UNLESS OTHERWISE NOTED) P-CHANNEL

