

54F/74F64

4-2-3-2-Input AND-OR-Invert Gate

General Description

This device contains gates configured to perform a 4-2-3-2 input AND-OR-INVERT function.

| Commercial | Military | Package Number | Package Description |
|------------------|------------------|----------------|---|
| 74F64PC | | N14A | 14-Lead (0.300" Wide) Molded Dual-In-Line |
| | 54F64DM (Note 2) | J14A | 14-Lead Ceramic Dual-In-Line |
| 74F64SC (Note 1) | | M14A | 14-Lead (0.150" Wide) Molded Small Outline, JEDEC |
| | 54F64FM (Note 2) | W14B | 14-Lead Cerpack |
| | 54F64LM (Note 2) | E20A | 20-Lead Ceramic Leadless Chip Carrier, Type C |

Note 1: Devices also available in 13" reel. Use suffix = SCX.

Note 2: Military grade device with environmental and burn-in processing. Use suffix = DMQB, FMOB and LMQB.

Logic Symbol

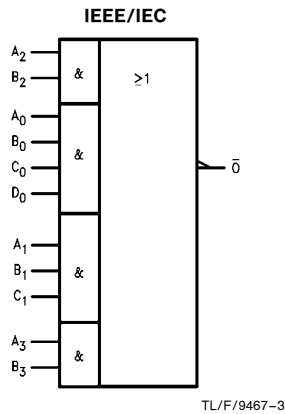

Connection Diagrams

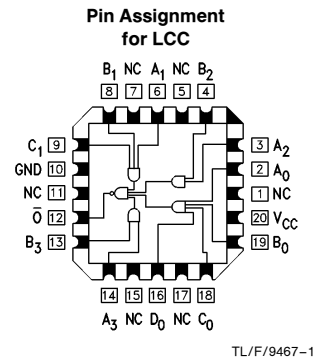
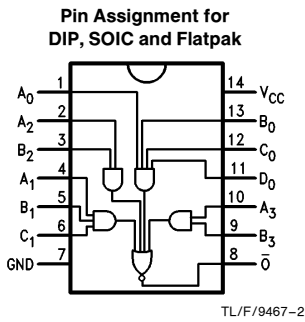

Unit Loading/Fan Out

| Pin Names | Description | 54F/74F | |
|----------------------|-------------|------------------|---|
| | | U.L. HIGH/LOW | Input I_{IH}/I_{IL} Output I_{OH}/I_{OL} |
| A_n, B_n, C_n, D_n | Inputs | 1.0/1.0 | 20 μ A/ -0.6 mA |
| \bar{O} | Output | 50/33.3 | -1 mA/20 mA |

TRI-STATE® is a registered trademark of National Semiconductor Corporation.

Absolute Maximum Ratings (Note 1)

If Military/Aerospace specified devices are required, please contact the National Semiconductor Sales Office/Distributors for availability and specifications.

| | |
|---|--------------------------|
| Storage Temperature | –65°C to +150°C |
| Ambient Temperature under Bias | –55°C to +125°C |
| Junction Temperature under Bias | –55°C to +175°C |
| Plastic | –55°C to +150°C |
| V _{CC} Pin Potential to Ground Pin | –0.5V to +7.0V |
| Input Voltage (Note 2) | –0.5V to +7.0V |
| Input Current (Note 2) | –30 mA to +5.0 mA |
| Voltage Applied to Output in HIGH State (with V _{CC} = 0V) | |
| Standard Output | –0.5V to V _{CC} |
| TRI-STATE® Output | –0.5V to +5.5V |

Current Applied to Output in LOW State (Max) twice the rated I_{OL} (mA)

Note 1: Absolute maximum ratings are values beyond which the device may be damaged or have its useful life impaired. Functional operation under these conditions is not implied.

Note 2: Either voltage limit or current limit is sufficient to protect inputs.

Recommended Operating Conditions

| | |
|------------------------------|-----------------|
| Free Air Ambient Temperature | |
| Military | –55°C to +125°C |
| Commercial | 0°C to +70°C |
| Supply Voltage | |
| Military | +4.5V to +5.5V |
| Commercial | +4.5V to +5.5V |

DC Electrical Characteristics

| Symbol | Parameter | | 54F/74F | | | Units | V _{CC} | Conditions |
|------------------|-----------------------------------|--|-------------------|-----|-----|-------|-----------------|---|
| | | | Min | Typ | Max | | | |
| V _{IH} | Input HIGH Voltage | | 2.0 | | | V | | Recognized as a HIGH Signal |
| V _{IL} | Input LOW Voltage | | | | | V | | Recognized as a LOW Signal |
| V _{CD} | Input Clamp Diode Voltage | | | | | V | Min | I _{IN} = –18 mA |
| V _{OH} | Output HIGH Voltage | 54F 10% V _{CC} 74F 10% V _{CC} 74F 5% V _{CC} | 2.5 2.5 2.7 | | | V | Min | I _{OH} = –1 mA I _{OH} = –1 mA I _{OH} = –1 mA |
| V _{OL} | Output LOW Voltage | 54F 10% V _{CC} 74F 10% V _{CC} | 0.5 0.5 | | | V | Min | I _{OL} = 20 mA I _{OL} = 20 mA |
| I _{IH} | Input HIGH Current | 54F 74F | 20.0 5.0 | | | μA | Max | V _{IN} = 2.7V |
| I _{BVI} | Input HIGH Current Breakdown Test | 54F 74F | 100 7.0 | | | μA | Max | V _{IN} = 7.0V |
| I _{CEX} | Output High Leakage Current | 54F 74F | 250 50 | | | μA | Max | V _{OUT} = V _{CC} |
| V _{ID} | Input Leakage Test | 74F | 4.75 | | | V | 0.0 | I _{ID} = 1.9 μA All Other Pins Grounded |
| I _{OD} | Output Leakage Circuit Current | 74F | 3.75 | | | μA | 0.0 | V _{IOD} = 150 mV All Other Pins Grounded |
| I _{IL} | Input LOW Current | | –0.6 | | | mA | Max | V _{IN} = 0.5V |
| I _{OS} | Output Short-Circuit Current | | –60 –150 | | | mA | Max | V _{OUT} = 0V |
| I _{CCH} | Power Supply Current | | 1.9 2.8 | | | mA | Max | V _O = HIGH |
| I _{CCL} | Power Supply Current | | 3.1 4.7 | | | mA | Max | V _O = LOW |

AC Electrical Characteristics

| Symbol | Parameter | 74F | | | 54F | | 74F | | Units |
|------------------|--|---|-----|-----|--|-----|--|-----|-------|
| | | T _A = +25°C V _{CC} = +5.0V C _L = 50 pF | | | T _A , V _{CC} = Mil C _L = 50 pF | | T _A , V _{CC} = Com C _L = 50 pF | | |
| | | Min | Typ | Max | Min | Max | Min | Max | |
| t _{PLH} | Propagation Delay | 2.5 | 4.6 | 6.5 | 2.5 | 8.5 | 2.5 | 7.5 | ns |
| t _{PHL} | A _n , B _n , C _n , D _n to \bar{O} | 1.5 | 3.2 | 4.5 | 1.5 | 6.5 | 1.5 | 5.5 | |

Ordering Information

The device number is used to form part of a simplified purchasing code where the package type and temperature range are defined as follows:

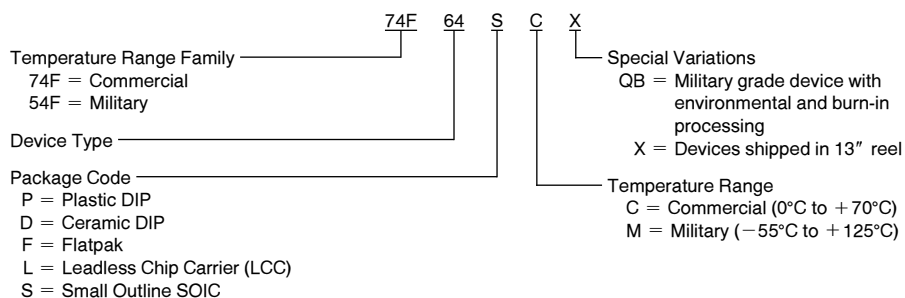

Physical Dimensions inches (millimeters)

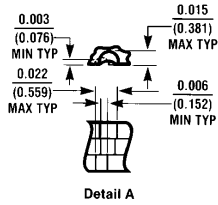
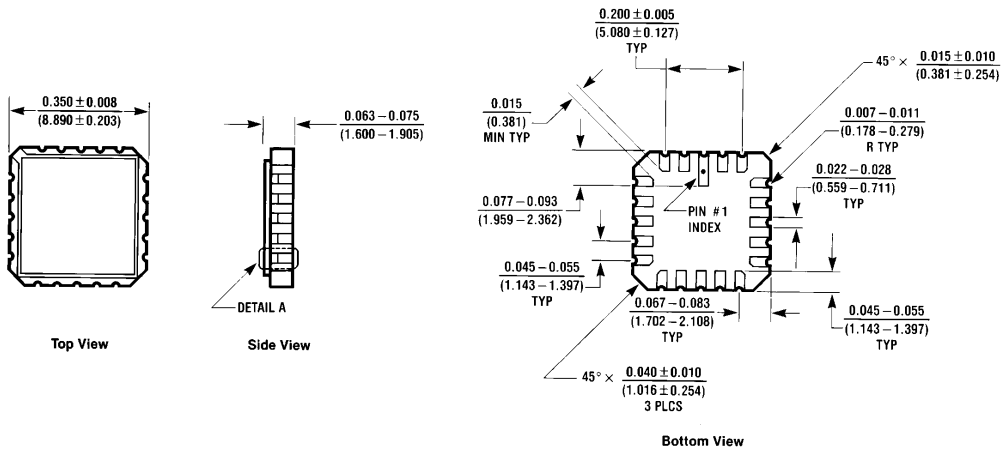

20-Lead Ceramic Leadless Chip Carrier (L)
NS Package Number E20A

E20A (REV D)

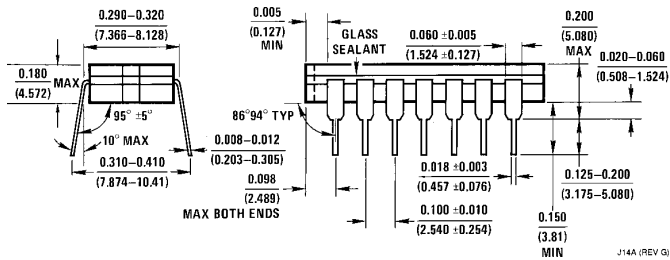
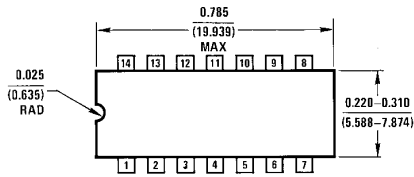

14-Lead Ceramic Dual-In-Line Package (D)
NS Package Number J14A

J14A (REV G)

Physical Dimensions inches (millimeters) (Continued)

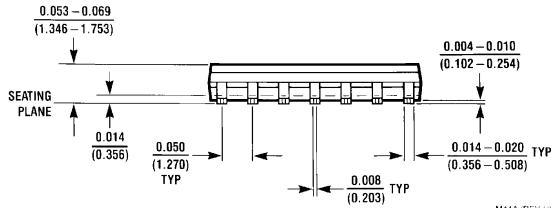
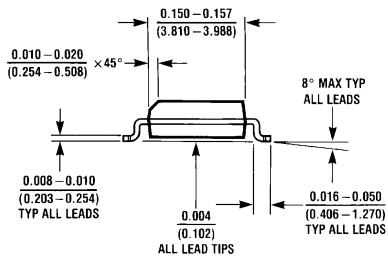
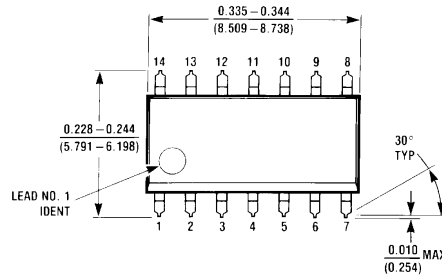

M14A (REV. H)

**14-Lead (0.150" Wide) Molded Small Outline, JEDEC (S)
NS Package Number M14A**

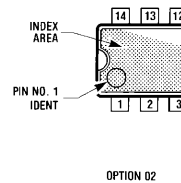
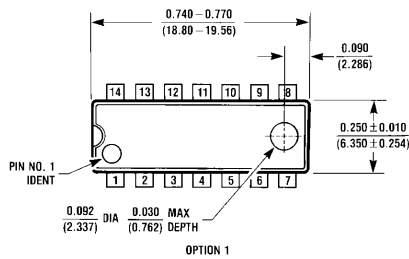

OPTION 1

OPTION 2

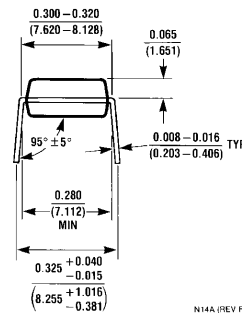
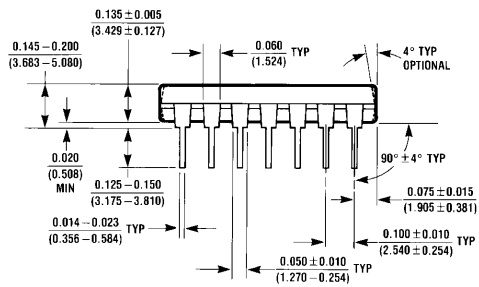

N14A (REV. F)

**14-Lead (0.300" Wide) Molded Dual-In-Line Package (P)
NS Package Number N14A**

Physical Dimensions inches (millimeters) (Continued)

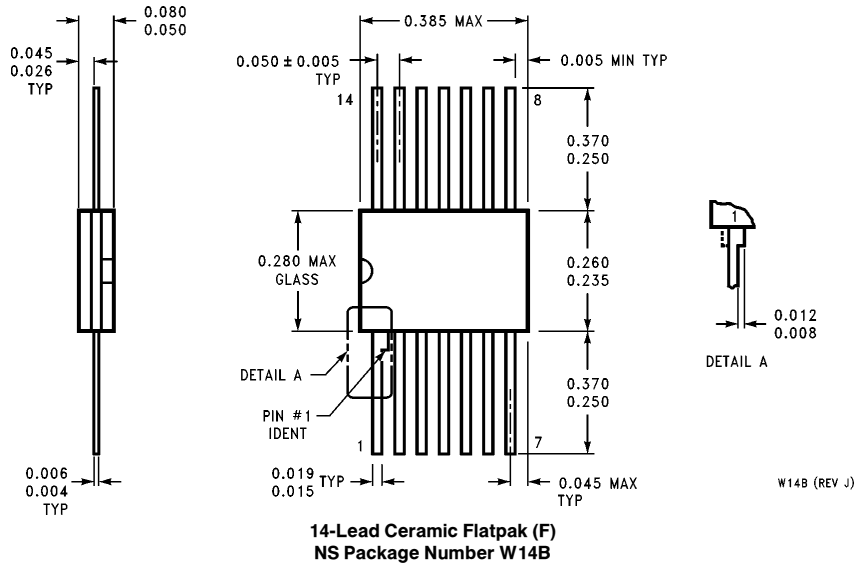

LIFE SUPPORT POLICY

NATIONAL'S PRODUCTS ARE NOT AUTHORIZED FOR USE AS CRITICAL COMPONENTS IN LIFE SUPPORT DEVICES OR SYSTEMS WITHOUT THE EXPRESS WRITTEN APPROVAL OF THE PRESIDENT OF NATIONAL SEMICONDUCTOR CORPORATION. As used herein:

1. Life support devices or systems are devices or systems which, (a) are intended for surgical implant into the body, or (b) support or sustain life, and whose failure to perform, when properly used in accordance with instructions for use provided in the labeling, can be reasonably expected to result in a significant injury to the user.
2. A critical component is any component of a life support device or system whose failure to perform can be reasonably expected to cause the failure of the life support device or system, or to affect its safety or effectiveness.



National Semiconductor Corporation
1111 West Bardin Road
Arlington, TX 76017
Tel: 1(800) 272-9959
Fax: 1(800) 737-7018

National Semiconductor Europe
Fax: (+49) 0-180-530 85 86
Email: cnjwge@tevm2.nsc.com
Deutsch Tel: (+49) 0-180-530 85 85
English Tel: (+49) 0-180-532 78 32
Français Tel: (+49) 0-180-532 93 58
Italiano Tel: (+49) 0-180-534 16 80

National Semiconductor Hong Kong Ltd.
19th Floor, Straight Block,
Ocean Centre, 5 Canton Rd.
Tsimshatsui, Kowloon
Hong Kong
Tel: (852) 2737-1600
Fax: (852) 2736-9960

National Semiconductor Japan Ltd.
Tel: 81-043-299-2309
Fax: 81-043-299-2408