

TOSHIBA INTELLIGENT POWER DEVICE SILICON MONOLITHIC POWER MOS IC

TPD1028AS

LOW-SIDE SWITCH FOR MOTOR, SOLENOID AND LAMP DRIVE

TPD1028AS is a monolithic power IC for low-side switch. The IC has a vertical MOSFET output which can be directly driven from a CMOS or TTL logic circuit (e.g., an MPU). The IC offers intelligent self-protection functions.

FEATURES

- A monolithic power IC with a new structure combining a control block and a vertical power MOSFET (π -MOS) on a single chip.
- Can directly drive a power load from a CMOS logic etc.
- Built-in protection circuits against overvoltage, overheat, and overcurrent.
- Low ON-resistance. $R_{DS(ON)} = 0.25 \Omega$ (Max.) (@ $V_{IN} = 5V$, $T_j = 25^\circ C$)
- Package TPS can be packed in tape.

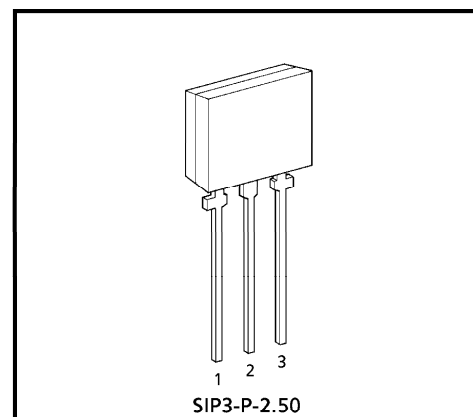

Weight : 0.54 g (Typ.)

PIN ASSIGNMENT

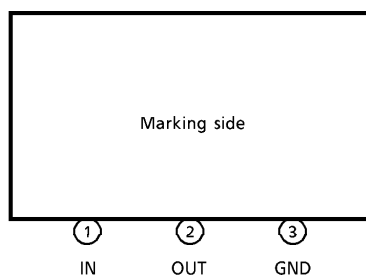

(Note) That because of its MOS structure, this product is sensitive to static electricity.

980910EBA1

- TOSHIBA is continually working to improve the quality and the reliability of its products. Nevertheless, semiconductor devices in general can malfunction or fail due to their inherent electrical sensitivity and vulnerability to physical stress. It is the responsibility of the buyer, when utilizing TOSHIBA products, to observe standards of safety, and to avoid situations in which a malfunction or failure of a TOSHIBA product could cause loss of human life, bodily injury or damage to property. In developing your designs, please ensure that TOSHIBA products are used within specified operating ranges as set forth in the most recent products specifications. Also, please keep in mind the precautions and conditions set forth in the TOSHIBA Semiconductor Reliability Handbook.
- The products described in this document are subject to the foreign exchange and foreign trade laws.
- The information contained herein is presented only as a guide for the applications of our products. No responsibility is assumed by TOSHIBA CORPORATION for any infringements of intellectual property or other rights of the third parties which may result from its use. No license is granted by implication or otherwise under any intellectual property or other rights of TOSHIBA CORPORATION or others.
- The information contained herein is subject to change without notice.

BLOCK DIAGRAM

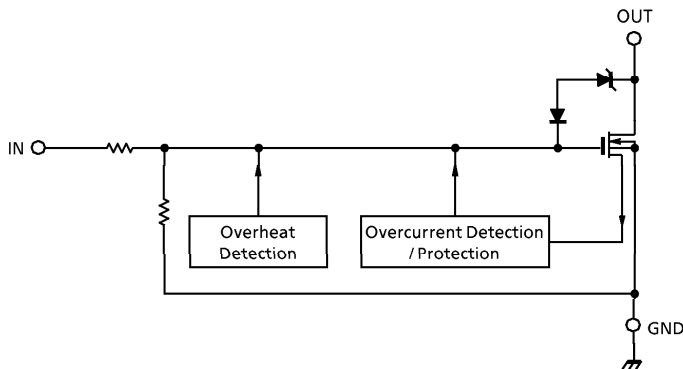

PIN DESCRIPTION

PIN No.	SYMBOL	PIN DESCRIPTION
1	IN	Input pin. This pin is connected to a pull-down resistor internally, so that even when input wiring is open-circuited, output can never be turned on inadvertently.
2	OUT	Output pin. If an inrush current flows (e.g., from a lamp), the current is clamped at 10 A (typ.) by an overcurrent protective circuit. Also, a 150 μs (typ.) mask circuit is included internally, so that if $V_{DS} \geq 12$ V (typ.) after this mask time, the current is clamped at 3 A (Typ.).
3	GND	Ground pin.

TIMING CHART

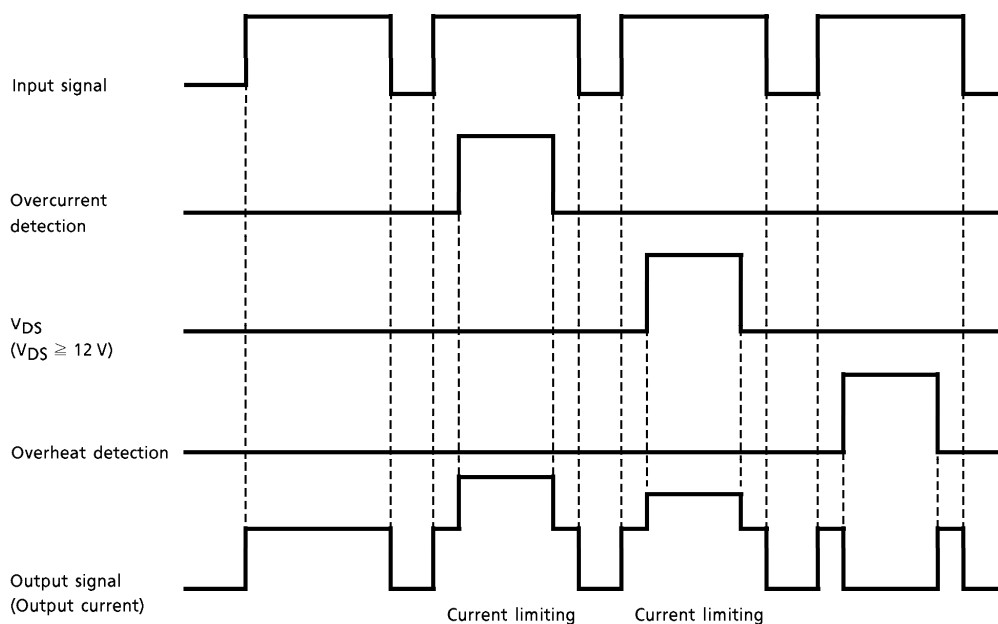

TRUTH TABLE

IN	VOUT	MODE
L	H	Normal
H	L	
L	H	Overcurrent (during inrush)
H	L	
L	H	Overcurrent (shorted load)
H	L	
L	H	Overheat
H	H	

MAXIMUM RATING (Ta = 25°C)

CHARACTERISTIC	SYMBOL	RATING	UNIT
Drain-source Voltage	V _{DS} (DC)	40	V
Output Current	I _D	1.5	A
Input Voltage	V _{IN}	-0.5~6	V
Power Dissipation	P _D	1.2	W
Energy Tolerance	ES / B	200	mJ
Operating Temperature	T _{opr}	-40~85	°C
Junction Temperature	T _j	150	°C

ELECTRICAL CHARACTERISTICS (Tj = 25°C)

CHARACTERISTIC	SYMBOL	TEST CIR-CUIT	TEST CONDITION	MIN.	TYP.	MAX.	UNIT
Drain-source Breakdown Voltage	V _{(BR) DSS}	—	V _{IN} = 0 V, I _D = 10 mA	40	—	—	V
Operating Supply Voltage	V _{DD}	—	—	—	—	38	V
High Level Input Voltage	V _{IH}	—	V _{DS} = 24 V, I _D = 1 A	4.5	5	5.5	V
Low Level Input Voltage	V _{IL}	—	V _{DS} = 24 V, I _D = 10 μA	—	—	0.8	V
Current at Output Off	I _{DSS} (1)	—	V _{IN} = 0 V, V _{DS} = 40 V	—	—	100	μA
	I _{DSS} (2)	—	V _{IN} = 0 V, V _{DS} = 24 V	—	—	10	
Input Current	I _{IN}	—	V _{IN} = 5 V, at normal operation	—	—	300	μA
ON-Resistance	R _{DS} (ON)	—	V _{IN} = 5 V, I _D = 1 A	—	—	0.25	Ω
Overheat Protection	T _S	—	V _{IN} = 5 V	—	160	—	°C
Overcurrent Protection	I _S (1)	—	V _{DS} = 24 V, V _{IN} = 5 V, during inrush	—	10	—	A
	I _S (2)	—	V _{DS} = 24 V, V _{IN} = 5 V, when shorted load	—	3	—	
Shorted Load Detection Voltage	V _{DS}	—	When shorted load	—	12	—	V
Switching Time	t _{ON}	1	V _{DS} = 24 V, V _{IN} = 5 V, R _L = 24 Ω	—	70	—	μs
	t _{OFF}			—	120	—	
Diode Forward Voltage Between Drain and Source	V _{DSF}	—	I _F = 1.5 A	—	0.9	1.8	V

TEST CIRCUIT 1

Switching time measuring circuit

Test circuit

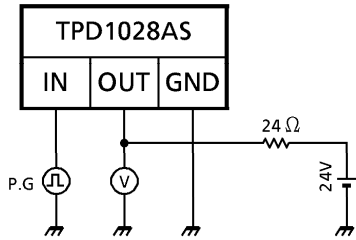

Measured waveforms

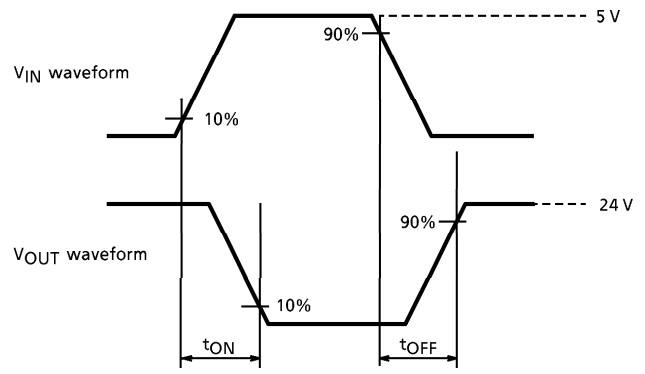

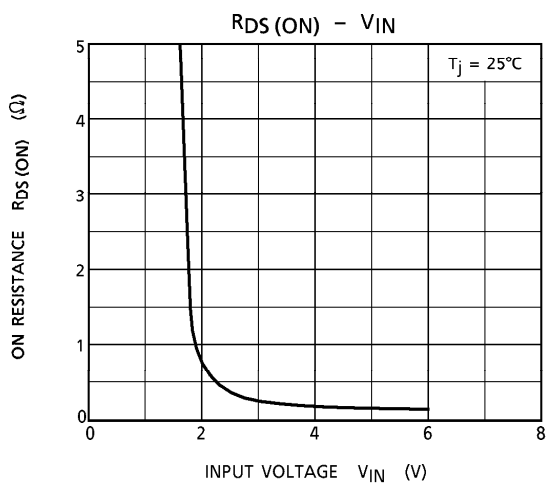
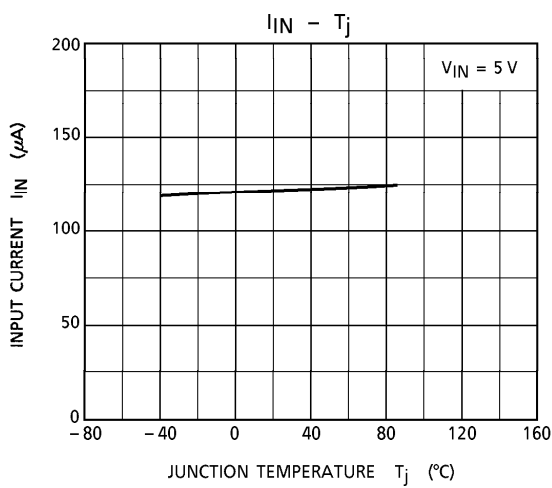
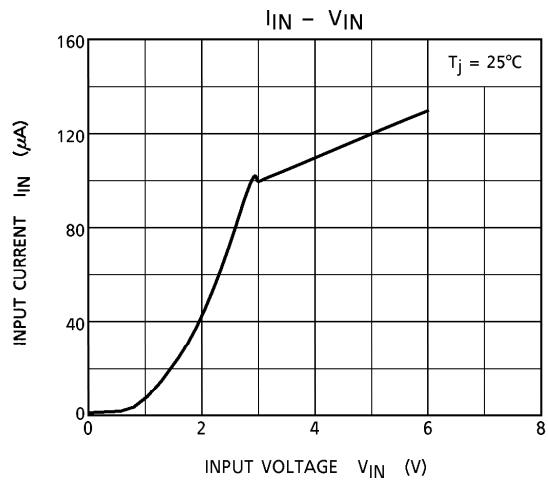
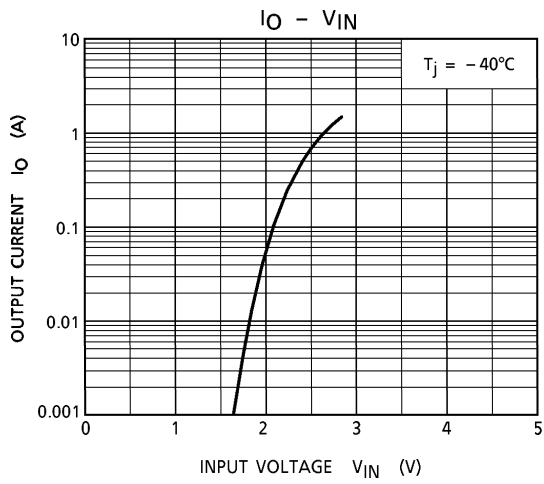
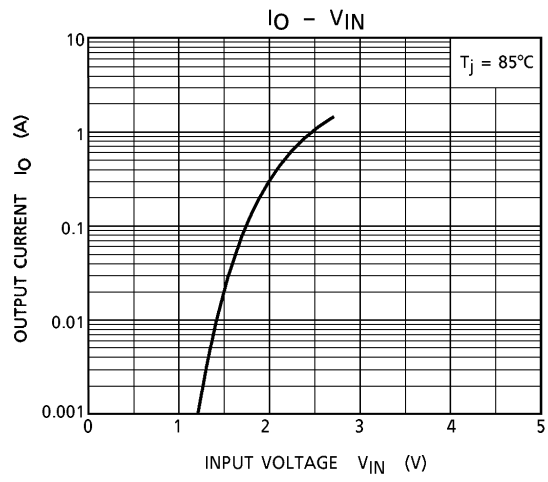
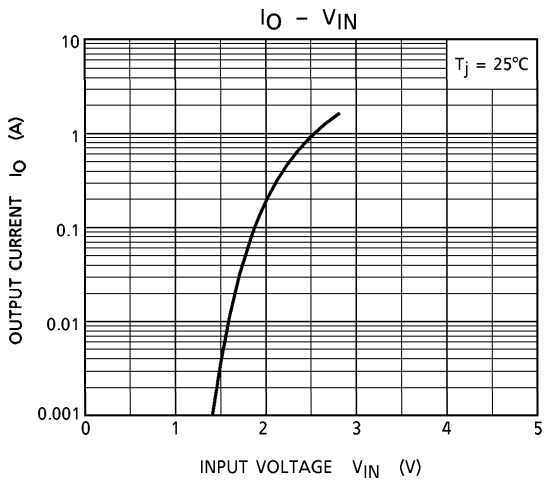

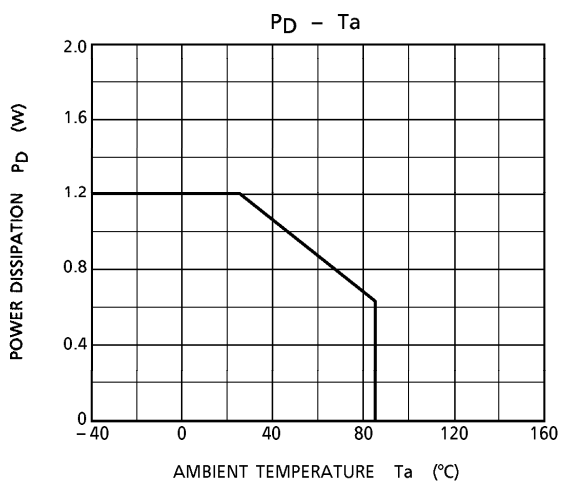
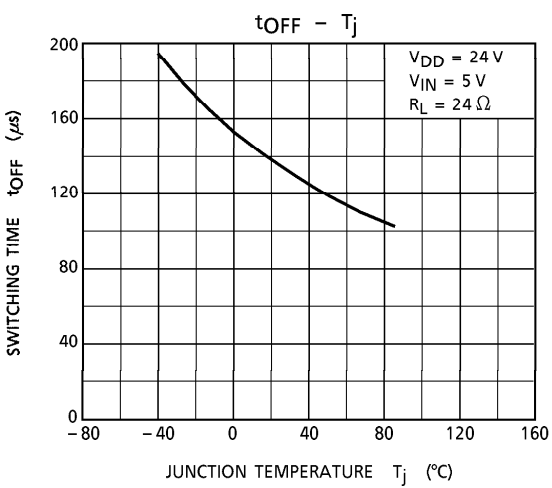
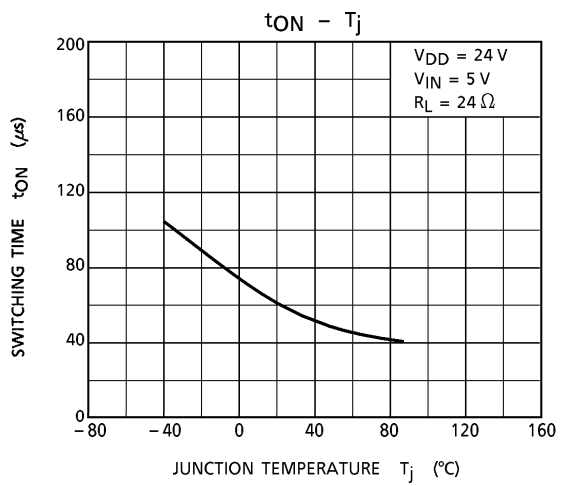
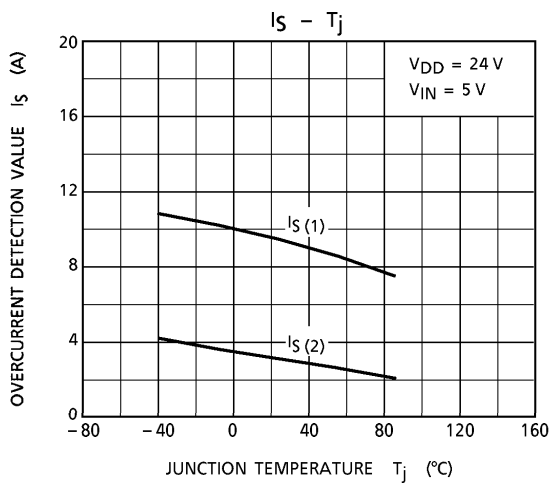
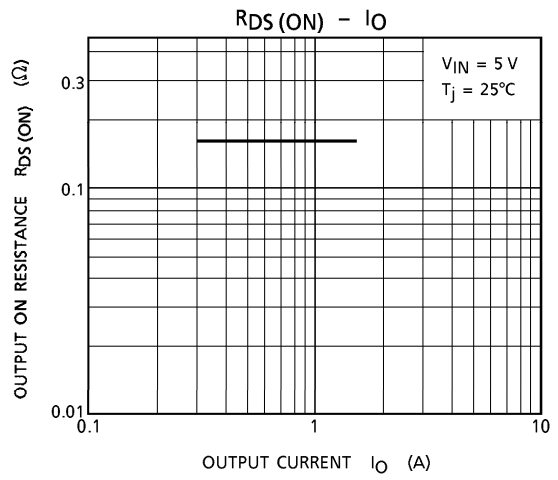
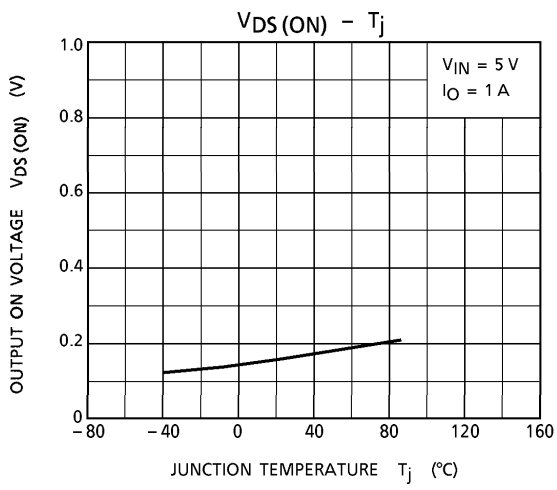

OUTLINE DRAWING
SIP3-P-2.50

Unit : mm

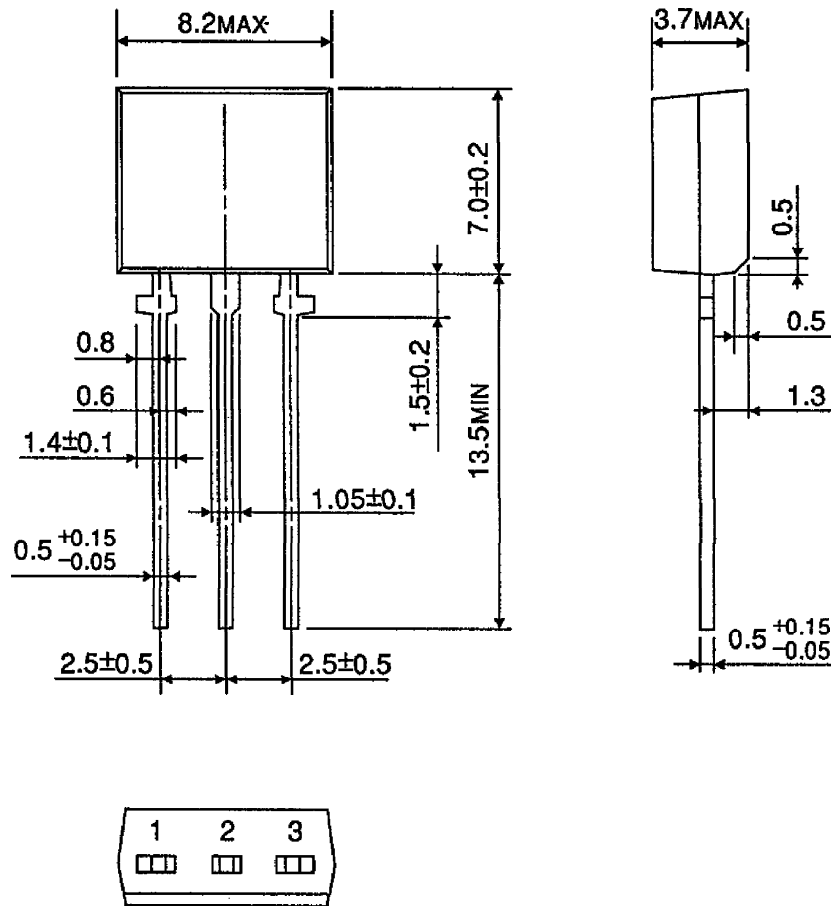

Weight : 0.54 g (Typ.)