



Band Pass and Band Reject

Description:

The 828BP and 828BR Series are 4-pole-pair digitally programmable band-pass and band-reject (notch) active filters. These new filters take advantage of the company's proprietary designs using surface-mount technology to provide a low profile, compact package in minimal board space. 828BP and 828BR filters are factory tuned to one of three factory set tuning ranges or 8-bit custom ranges from 1 Hz to 25.6 kHz. Each filter type features a near theoretical amplitude/phase response along with low output voltage noise enabling these filters to achieve a 10,000:1 or better dynamic signal range

Pretuned to within $\pm 2\%$ of the center frequency, band-pass 828BP filters pass all frequencies lying between the upper and lower -3 dB points of the amplitude response curve, while 828BR band-reject (notch) filters sharply attenuate those frequencies that are bound and defined by the bottom of the notch. Available Q's for 828BP models are 1, 2, 5, or 10 and 828BR filters are 3 or 10.

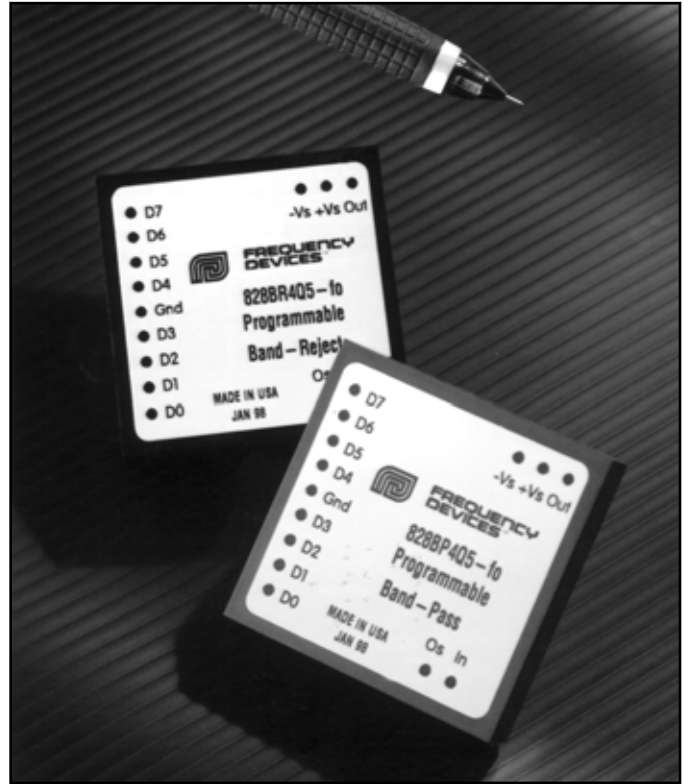
**Features/Benefits:**

- Compact 2.0"L x 2.0"W footprint minimizes board space requirements.
- Plug-in ready-to-use, reducing engineering design and manufacturing cycle time.
- Factory tuned, no external clocks or adjustments needed.
- Broad range of center frequencies to meet a wide range of applications.

Applications

- Power line interference rejection
- Transducer output filtering
- Production test instrumentation
- Medical electronics equipment and research
- Comb filtering and equalization
- Noise and harmonic analysis
- RMS measurements
- Frequency spectrum analysis

Programmable Specifications:	Page
Digital Tuning & Control	2

Available Band-Pass Models:	
828BP4 4 pole pair	3

Available Band-Reject Models:	
828BR4 4-pole pair	3

General Specifications:	
Ordering Information	4
Pin-Out/package data	4



Digital Tuning & Control Characteristics

8-Bit Programmable Filters

Digital Tuning Characteristics

The digital tuning interface circuits are a parallel set of eight (8) 4053 CMOS switches which accept CMOS compatible inputs for the eight tuning bits (D₀ - D₇).

Filter tuning follows the tuning equation given below:

$$f_c = (f_{max}/256) [1 + D_7 \times 2^7 + D_6 \times 2^6 + D_5 \times 2^5 + D_4 \times 2^4 + D_3 \times 2^3 + D_2 \times 2^2 + D_1 \times 2^1 + D_0 \times 2^0]$$

where D₁ - D₇ = "0" or "1", and

f_{max} = Maximum tuning frequency;

f_c = corner frequency;

Minimum tunable frequency = f_{max}/256 (D₀ thru D₇ = 0);

Minimum frequency step (Resolution) = f_{max}/256

Data Input Specifications

Input Data Levels (CMOS Logic)

Input Voltage (V_s = 15 Vdc)

Low Level In	0 Vdc min.	4 Vdc max.
High Level In	11 Vdc min.	15 Vdc max.

Input Current

High Level In	- 10 ⁻⁵ μA typ.	-1 μA max..
Low Level In	+10 ⁻⁵ μA typ.	+1 μA max.

Input Capacitance 5 pF typ 7.5 pF max.

Input Data Format Frequency Select Bits

Positive Logic Logic "1" = +V_s
Logic "0" = Gnd

Bit Weighting (Binary-Coded)

D₀ LSB (least significant bit)
D₇ MSB (most significant bit)

Frequency Range 256 : 1, Binary Weighted

Pin-Out Key

IN	Analog Input Signal	D ₇ Tuning Bit 7 (MSB)
OUT	Analog Output Signal	D ₆ Tuning Bit 6
GND	Power and Signal Return	D ₅ Tuning Bit 5
+V _s	Supply Voltage, Positive	D ₄ Tuning Bit 4
-V _s	Supply Voltage, Negative	D ₃ Tuning Bit 3
Os	Offset Adjustment	D ₂ Tuning Bit 2
		D ₁ Tuning Bit 1
		D ₀ Tuning Bit 0 (LSB)

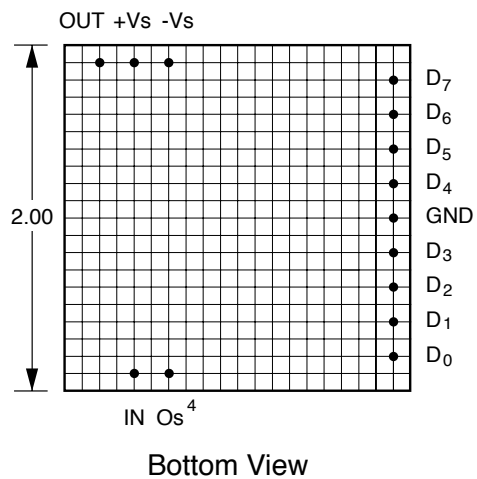

MSB	---	---	---	---	---	---	LSB	Bit Weight
D ₇	D ₆	D ₅	D ₄	D ₃	D ₂	D ₁	D ₀	f _c Corner Frequency
0	0	0	0	0	0	0	0	f _{max} /256
0	0	0	0	0	0	0	1	f _{max} /128
0	0	0	0	0	0	1	1	f _{max} /64
0	0	0	0	0	1	1	1	f _{max} /32
0	0	0	0	1	1	1	1	f _{max} /16
0	0	0	1	1	1	1	1	f _{max} /8
0	0	1	1	1	1	1	1	f _{max} /4
0	1	1	1	1	1	1	1	f _{max} /2
1	1	1	1	1	1	1	1	f _{max}



Band-Pass & Band-Reject

Model	828BP4	Model	828BR4
Product Specifications	Band-Pass	Product Specifications	Band-Reject
Size Model 2 Model 3 & 4	2.0" x 2.0" x 0.6" 2.0" x 2.0" x 0.5"	Size Model 2 Model 3 & 4	2.0" x 2.0" x 0.6" 2.0" x 2.0" x 0.5"
Range f_o	1 Hz to 25.6 kHz	Range f_o	1 Hz to 25.6 kHz
Available "Q's"¹	1, 2, 5, 10	Available "Q's"¹	3, 10
Q Accuracy	±10%	Q Accuracy	±10%
Theoretical Transfer Characteristics	Appendix A Pages 41 & 42	Theoretical Transfer Characteristics	Appendix A Pages 43
Pass-Band Gain (non-inverting)	0± 0.25 dB typ. 0± 0.50 dB max.	Pass-Band Gain (non-inverting)	0± 0.25 dB typ. 0± 0.50 dB max.
Attenuation Rate	24 dB/octave	Attenuation Rate	24 dB/octave
Center Frequency	f _o ±2% max.	Center Frequency	f _o ±2% max.
Stability	±0.01%/°C	Stability	±0.01%/°C
Filter Mounting Assembly	FMA-02A	Filter Mounting Assembly	FMA-02A

1. Q – Quality Factor for band-pass and band-reject filters. $Q = f_o / (f_H - f_L)$ $f_o = \sqrt{f_H f_L}$



Specification (25°C and Vs ±15Vdc)

Pin-Out and Package Data Ordering Information

Analog Input Characteristics¹

Impedance	10 k Ω min.
Voltage Range	± 10 Vpeak
Max. Safe Voltage	±Vs

Analog Output Characteristics

Impedance (Closed Loop)	1 Ω typ. 10 Ω max.
Linear Operating Range	±10V
Maximum Current ²	±2 mA
Offset Voltage ³	2 mV typ. 20 mV max.
Offset Temp. Coeff.	50 μV/°C

Power Supply (±V)

Rated Voltage	±15 Vdc
Operating Range	±12 to ±18 Vdc
Maximum Safe Voltage	±18 Vdc

Quiescent Current	±25 mA typ. ±40 mA max.
-------------------	----------------------------

Temperature

Operating	0 to +70°C
Storage	-25 to +85°C

Notes:

1. Input and output signal voltage referenced to supply common.
2. Output is short circuit protected to common.
DO NOT CONNECT TO ±Vs.
3. Adjustable to zero.
4. Units operate with or without offset pin connected.

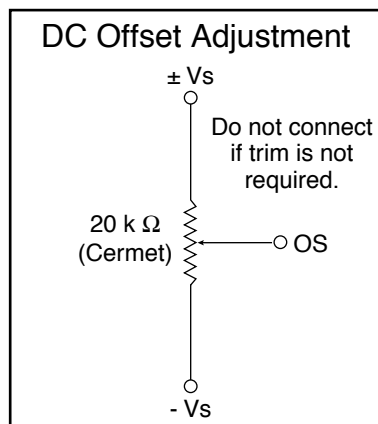

Pin-Out & Package Data

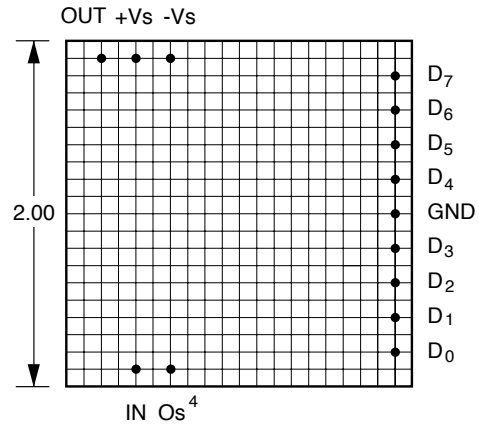
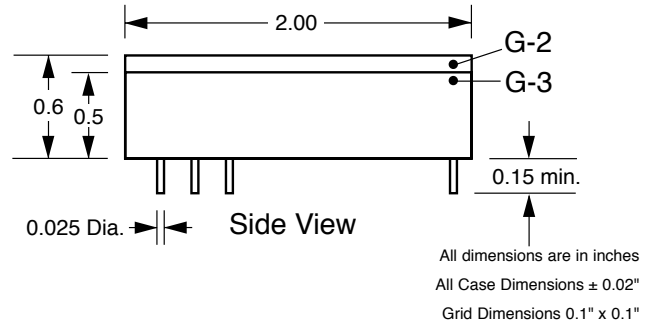

Bottom View

Filter Mounting Assembly-See FMA-02A

Ordering Information

Filter Type

BP - Band Pass
BR - Band Reject

828BP4/10-4

"Q"
BP - 1, 2, 5, 10
BR - 3, 10

Model	Model Number	Tuning Range (Hz)	Minimum Step(Hz)	Case
	2	1.0 to 256	1.0	G-2
	3	10 to 2560	10	G-3
	4	100 to 25.6k	100	G-3

We hope the information given here will be helpful. The information is based on data and our best knowledge, and we consider the information to be true and accurate. Please read all statements, recommendations or suggestions herein in conjunction with our conditions of sale which apply to all goods supplied by us. We assume no responsibility for the use of these statements, recommendations or suggestions, nor do we intend them as a recommendation for any use which would infringe any patent or copyright. **PR-828BP/BR-03**



Programmable Filter Modules Power Sequence & ESD

November 2000

Programmable Filters Modules

818, 824, 828, 828BP, 828BR, 854, 858, R854, R858

I. Scope

The following precautions are necessary when handling and installing Frequency Devices programmable filter modules.

II. Digital Circuit Description

The digital input pins connect directly to 4000 series CMOS logic, such as the 4053 analog switch. The power supply (V_{ss}) for the digital logic on the module comes directly from the +15 Volt pin on the module. This sets the threshold voltage at 11.0 V minimum to 15.0 V maximum for a "1" (High) level and 0.0 V minimum to 4.0 V maximum for a "0" (Low) level. Applying a voltage between 4.0 and 11.0 V will produce unpredictable operation. Connecting 5 Volt or 3.3 V logic devices directly to the filter module without using a voltage translator will result in erratic operation of the filter.

III. (VERY IMPORTANT) Power-Up and Power-Down Sequence

Do not plug-in or un-plug module while power is applied. It is imperative that power is supplied to the + 15 V pin on the filter module before or at the same instance that any digital pin is pulled High (> 0.0 V). Failure to do this will result in excessive current flowing through the digital input pin and through a protection diode internal to the 4000 logic, which will result in damage to the module. The proper power-up and power-down sequence is:

1. Connect filter module ground.
2. Connect filter module +15 V.
3. Connect filter module -15 V.
4. Connect the input signal.

All four of the above steps can also occur simultaneously. Power-down should occur in the reverse order.

IV. ESD Issues

Like most modern electronic equipment, the modules can be damaged by electrostatic discharge (ESD). The modules are shipped from the factory in sealed, anti-static packaging and should be kept in the sealed package prior to mounting on a circuit board. The following additional rules should also be observed when handling the modules after they are removed from the factory packaging:

1. Only a person wearing a properly grounded wrist strap should handle the modules.
2. Any work surface that the modules are placed on must be properly ESD grounded.
3. Any insulating materials capable of generating static charge (such as paper) should be kept away from the modules.

Static generating clothing should be covered with an ESD-protective smock.



Appendix A

Amplitude Response Curves

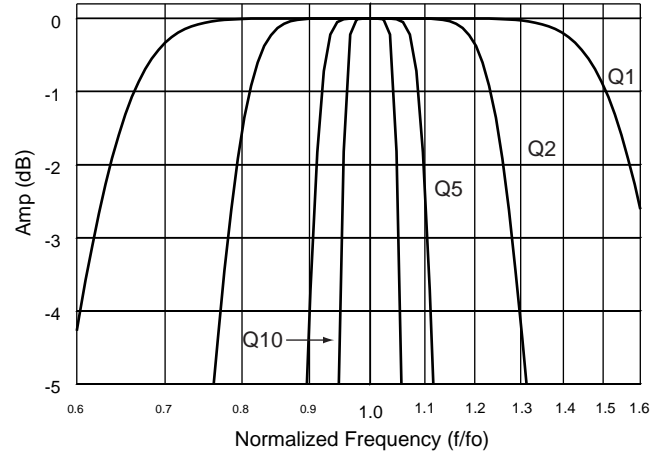
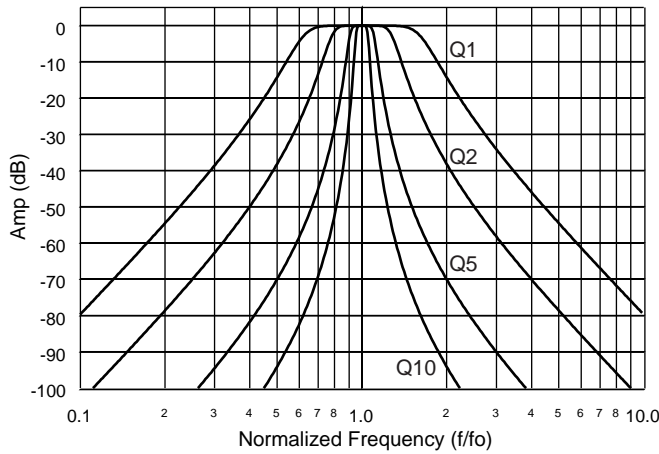

Normalized Theoretical Amplitude Data

Amp (dB)	Q = 1		Q = 2		Q = 5		Q = 10	
	$f_L < f_o < f_H$		$f_L < f_o < f_H$		$f_L < f_o < f_H$		$f_L < f_o < f_H$	
	f/f_o	f/f_o	f/f_o	f/f_o	f/f_o	f/f_o	f/f_o	f/f_o
-0.10	0.735	1.360	0.856	1.168	0.939	1.064	0.969	1.032
-0.25	0.709	1.411	0.840	1.191	0.932	1.073	0.965	1.036
-0.50	0.687	1.456	0.826	1.211	0.926	1.080	0.962	1.039
-1.00	0.663	1.508	0.811	1.233	0.919	1.088	0.959	1.043
-1.50	0.648	1.543	0.801	1.249	0.914	1.094	0.956	1.046
-2.00	0.636	1.571	0.793	1.261	0.911	1.098	0.954	1.048
-2.50	0.627	1.596	0.787	1.271	0.908	1.102	0.953	1.050
-3.00	0.618	1.618	0.781	1.281	0.905	1.105	0.951	1.051
-5.00	0.591	1.692	0.762	1.313	0.896	1.116	0.946	1.057
-10.00	0.539	1.855	0.724	1.382	0.877	1.140	0.936	1.068
-15.00	0.493	2.027	0.688	1.454	0.858	1.165	0.926	1.080
-20.00	0.449	2.225	0.650	1.538	0.838	1.193	0.915	1.093
-25.00	0.407	2.459	0.611	1.637	0.816	1.226	0.903	1.108
-30.00	0.365	2.737	0.570	1.755	0.791	1.265	0.888	1.126
-35.00	0.326	3.065	0.527	1.896	0.763	1.311	0.872	1.146
-40.00	0.290	3.452	0.484	2.065	0.733	1.365	0.854	1.171
-45.00	0.256	3.908	0.441	2.267	0.699	1.430	0.834	1.199
-50.00	0.225	4.442	0.399	2.507	0.664	1.507	0.811	1.233
-55.00	0.197	5.067	0.358	2.793	0.625	1.599	0.786	1.273
-60.00	0.173	5.796	0.319	3.131	0.585	1.710	0.758	1.320
-65.00	0.151	6.644	0.283	3.530	0.543	1.842	0.727	1.376
-70.00	0.131	7.630	0.250	4.000	0.500	2.000	0.693	1.443
-75.00	0.114	8.774	0.220	4.550	0.457	2.189	0.657	1.523
-80.00	0.099	10.01	0.193	5.193	0.414	2.414	0.618	1.618



Phase Response Curves

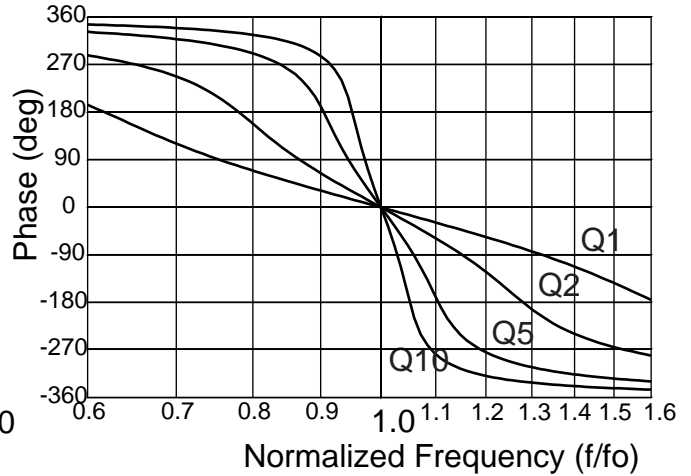
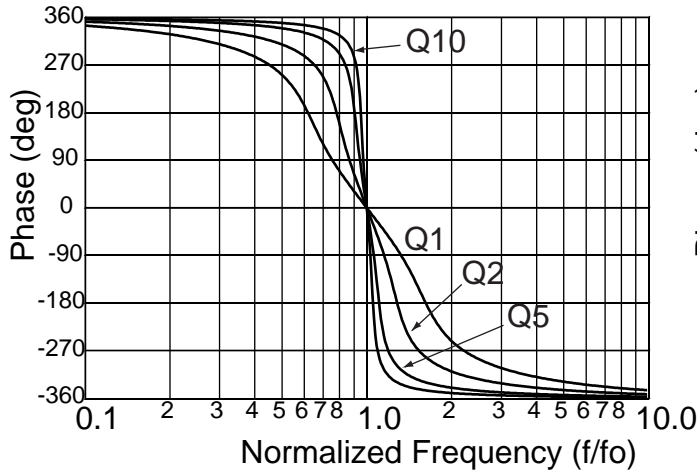

Normalized Theoretical Phase Data

Phase Mag (deg)	Q = 1		Q = 2		Q = 5		Q = 10	
	(+)	(-)	(+)	(-)	(+)	(-)	(+)	(-)
	f/f_0	f/f_0	f/f_0	f/f_0	f/f_0	f/f_0	f/f_0	f/f_0
1.0	0.997	1.003	0.998	1.002	0.999	1.001	1.000	1.000
2.5	0.992	1.008	0.996	1.004	0.998	1.002	0.999	1.001
5.0	0.983	1.017	0.992	1.008	0.997	1.003	0.998	1.002
10.0	0.967	1.034	0.983	1.017	0.993	1.007	0.997	1.003
15.0	0.951	1.051	0.975	1.025	0.990	1.010	0.995	1.005
20.0	0.936	1.069	0.967	1.034	0.987	1.013	0.993	1.007
25.0	0.920	1.087	0.959	1.042	0.984	1.017	0.992	1.008
30.0	0.905	1.105	0.951	1.051	0.980	1.020	0.990	1.010
35.0	0.891	1.123	0.944	1.060	0.977	1.023	0.988	1.012
40.0	0.876	1.141	0.936	1.068	0.974	1.027	0.987	1.013
45.0	0.863	1.159	0.929	1.077	0.971	1.030	0.985	1.015
50.0	0.849	1.178	0.921	1.086	0.968	1.033	0.984	1.017
60.0	0.823	1.215	0.907	1.103	0.962	1.040	0.981	1.020
70.0	0.799	1.252	0.893	1.120	0.956	1.046	0.978	1.023
80.0	0.776	1.288	0.880	1.136	0.950	1.052	0.975	1.026
90.0	0.755	1.324	0.868	1.152	0.945	1.058	0.972	1.029
120.0	0.701	1.426	0.835	1.198	0.930	1.075	0.964	1.037
150.0	0.657	1.521	0.807	1.239	0.917	1.090	0.958	1.044
180.0	0.618	1.618	0.781	1.281	0.905	1.105	0.951	1.051
210.0	0.577	1.734	0.752	1.330	0.891	1.122	0.944	1.060
240.0	0.525	1.904	0.713	1.403	0.872	1.147	0.933	1.071
270.0	0.452	2.210	0.653	1.532	0.840	1.191	0.916	1.092
300.0	0.345	2.899	0.548	1.825	0.777	1.288	0.880	1.136
330.0	0.192	5.211	0.350	2.859	0.617	1.621	0.780	1.282



Appendix A

Amplitude Response Curves

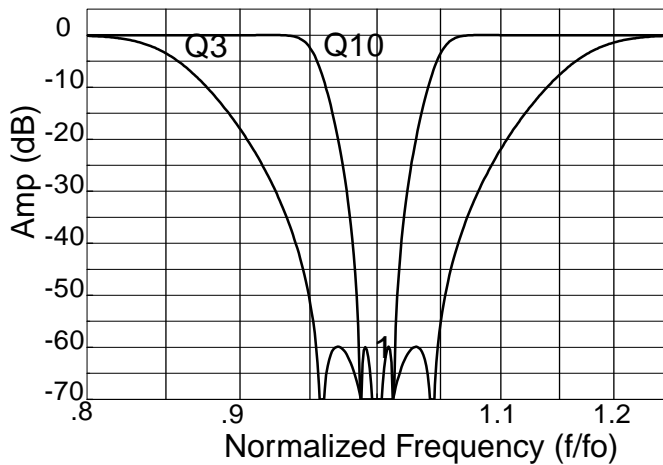

Phase Response Curves

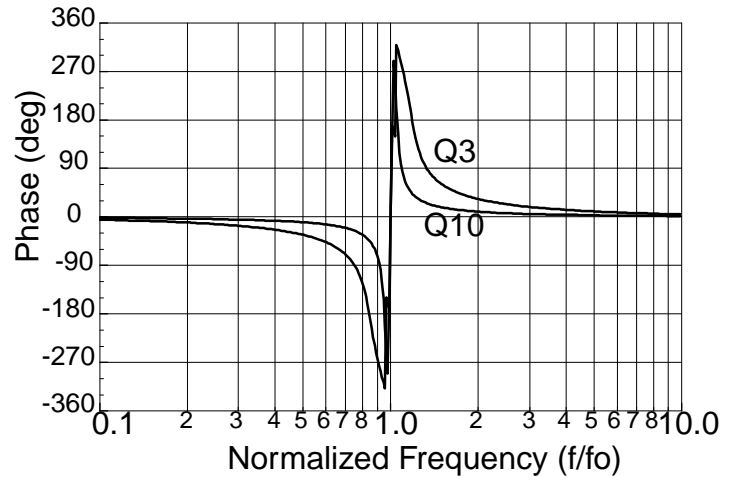

Normalized Theoretical Amplitude Data

Amp (dB)	Q = 3		Q = 10	
	$f_L < f < f_H$		$f_L < f < f_H$	
	f/f_0	f/f_0	f/f_0	f/f_0
-0.10	0.799	1.251	0.935	1.069
-0.25	0.809	1.236	0.938	1.066
-0.50	0.818	1.223	0.941	1.062
-1.00	0.828	1.208	0.945	1.059
-1.50	0.835	1.198	0.947	1.056
-2.00	0.839	1.191	0.949	1.054
-2.50	0.844	1.185	0.95	1.053
-3.00	0.847	1.180	0.951	1.051
-5.00	0.858	1.165	0.955	1.047
-10.00	0.877	1.140	0.961	1.040
-15.00	0.892	1.121	0.966	1.035
-20.00	0.905	1.105	0.97	1.030
-25.00	0.916	1.092	0.974	1.027
-30.00	0.925	1.081	0.977	1.024
-35.00	0.933	1.072	0.979	1.021
-40.00	0.939	1.065	0.982	1.019
-45.00	0.945	1.059	0.983	1.017
-50.00	0.949	1.054	0.984	1.016
-55.00	0.952	1.050	0.985	1.015
-60.00	0.954	1.048	0.986	1.014

Normalized Theoretical Phase Data

Phase Mag (deg)	Q = 3		Q = 10	
	(-)	(+)	(-)	(+)
	f/f_0	f/f_0	f/f_0	f/f_0
1.0	0.020	49.66	0.067	14.88
2.5	0.050	19.91	0.164	6.087
5.0	0.100	10.03	0.306	3.268
10.0	0.194	5.160	0.504	1.985
15.0	0.279	3.590	0.621	1.609
20.0	0.352	2.838	0.696	1.437
25.0	0.416	2.405	0.746	1.340
30.0	0.470	2.129	0.783	1.278
35.0	0.515	1.940	0.810	1.235
40.0	0.555	1.803	0.831	1.204
45.0	0.588	1.700	0.848	1.180
50.0	0.617	1.620	0.861	1.161
60.0	0.664	1.505	0.882	1.133
70.0	0.701	1.427	0.897	1.115
80.0	0.729	1.372	0.909	1.101
90.0	0.752	1.330	0.917	1.090
120.0	0.797	1.255	0.934	1.071
150.0	0.824	1.214	0.943	1.060
180.0	0.844	1.185	0.950	1.052
210.0	0.862	1.160	0.957	1.045