

## Zener diode

### Features

1. Small surface mounting type
2. High reliability



### Applications

Voltage stabilization

### Construction

Silicon epitaxial planar

### Absolute Maximum Ratings

$T_j=25^{\circ}\text{C}$

Parameter	Test Conditions	Type	Symbol	Value	Unit
Power dissipation	$R_{thJA} \leq 300\text{K/W}$		$P_V$	500	mW
Z-current			$I_Z$	$P_V/V_Z$	mA
Junction temperature			$T_j$	175	$^{\circ}\text{C}$
Storage temperature range			$T_{stg}$	-65~+175	$^{\circ}\text{C}$

### Maximum Thermal Resistance

$T_j=25^{\circ}\text{C}$

Parameter	Test Conditions	Symbol	Value	Unit
Junction ambient	on PC board 50mm × 50mm × 1.6mm	$R_{thJA}$	500	K/W

### Electrical Characteristics

$T_j=25^{\circ}\text{C}$

Parameter	Test Conditions	Type	Symbol	Min	Typ	Max	Unit
Forward voltage	$I_F=200\text{mA}$		$V_F$			1.5	V

Type	V <sub>Znom</sub>	I <sub>ZT</sub>	for V <sub>ZT</sub> and	r <sub>ZT</sub>	r <sub>ZK</sub> at	I <sub>ZK</sub>	I <sub>R</sub> and	I <sub>R</sub> at	V <sub>R</sub>	TK <sub>VZ</sub>
TZMC.	V	mA	V <sup>1)</sup>	Ω	Ω	mA	μ A	μ A <sup>2)</sup>	V	%/K
2V0	2.0	5	1.9~2.1	100	<600	1	<150	<300	1	-0.09~-0.06
2V2	2.2	5	2.09~2.31	100	<600	1	<150	<300	1	-0.09~-0.06
2V4	2.4	5	2.28~2.56	<85	<600	1	<50	<100	1	-0.09~-0.06
2V7	2.7	5	2.5~2.9	<85	<600	1	<10	<50	1	-0.09~-0.06
3V0	3.0	5	2.8~3.2	<85	<600	1	<4	<40	1	-0.08~-0.05
3V3	3.3	5	3.1~3.5	<85	<600	1	<2	<40	1	-0.08~-0.05
3V6	3.6	5	3.4~3.8	<85	<600	1	<2	<40	1	-0.08~-0.05
3V9	3.9	5	3.7~4.1	<85	<600	1	<2	<40	1	-0.08~-0.05
4V3	4.3	5	4.0~4.6	<75	<600	1	<1	<20	1	-0.06~-0.03
4V7	4.7	5	4.4~5.0	<60	<600	1	<0.5	<10	1	-0.05~+0.02
5V1	5.1	5	4.8~5.4	<35	<550	1	<0.1	<2	1	-0.02~+0.02
5V6	5.6	5	5.2~6.0	<25	<450	1	<0.1	<2	1	-0.05~+0.05
6V2	6.2	5	5.8~6.6	<10	<200	1	<0.1	<2	2	0.03~0.06
6V8	6.8	5	6.4~7.2	<8	<150	1	<0.1	<2	3	0.03~0.07
7V5	7.5	5	7.0~7.9	<7	<50	1	<0.1	<2	5	0.03~0.07
8V2	8.2	5	7.7~8.7	<7	<50	1	<0.1	<2	6.2	0.03~0.08
9V1	9.1	5	8.5~9.6	<10	<50	1	<0.1	<2	6.8	0.03~0.09
10	10	5	9.4~10.6	<15	<70	1	<0.1	<2	7.5	0.03~0.1
11	11	5	10.4~11.6	<20	<70	1	<0.1	<2	8.2	0.03~0.11
12	12	5	11.4~12.7	<20	<90	1	<0.1	<2	9.1	0.03~0.11
13	13	5	12.4~14.1	<26	<110	1	<0.1	<2	10	0.03~0.11
15	15	5	13.8~15.6	<30	<110	1	<0.1	<2	11	0.03~0.11
16	16	5	15.3~17.1	<40	<170	1	<0.1	<2	12	0.03~0.11
18	18	5	16.8~19.1	<50	<170	1	<0.1	<2	13	0.03~0.11
20	20	5	18.8~21.2	<55	<220	1	<0.1	<2	15	0.03~0.11
22	22	5	20.8~23.3	<55	<220	1	<0.1	<2	16	0.04~0.12
24	24	5	22.8~25.6	<80	<220	1	<0.1	<2	18	0.04~0.12
27	27	5	25.1~28.9	<80	<220	1	<0.1	<2	20	0.04~0.12
30	30	5	28~32	<80	<220	1	<0.1	<2	22	0.04~0.12
33	33	5	31~35	<80	<220	1	<0.1	<2	24	0.04~0.12
36	36	5	34~38	<80	<220	1	<0.1	<2	27	0.04~0.12
39	39	2.5	37~41	<90	<500	0.5	<0.1	<5	30	0.04~0.12
43	43	2.5	40~46	<90	<600	0.5	<0.1	<5	33	0.04~0.12
47	47	2.5	44~50	<110	<700	0.5	<0.1	<5	36	0.04~0.12
51	51	2.5	48~54	<125	<700	0.5	<0.1	<10	39	0.04~0.12
56	56	2.5	52~60	<135	<1000	0.5	<0.1	<10	43	0.04~0.12
62	62	2.5	58~66	<150	<1000	0.5	<0.1	<10	47	0.04~0.12
68	68	2.5	64~72	<200	<1000	0.5	<0.1	<10	51	0.04~0.12
75	75	2.5	70~79	<250	<1500	0.5	<0.1	<10	56	0.04~0.12

<sup>1)</sup> Tighter tolerances available request:

TZMB... ±2% of V<sub>Znom</sub>

<sup>2)</sup> at T<sub>J</sub>=150°C

## Characteristics ( $T_j=25^\circ\text{C}$ unless otherwise specified)

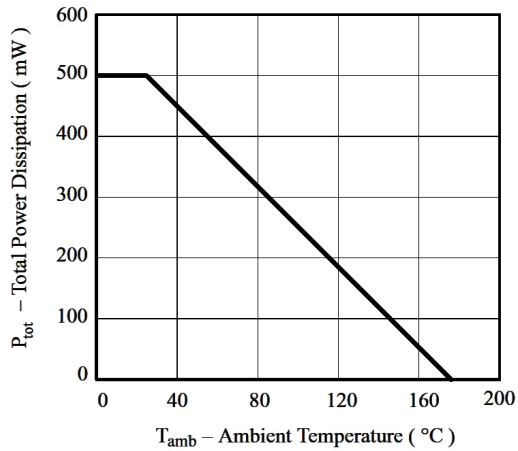

Figure 1. Total Power Dissipation vs. Ambient Temperature

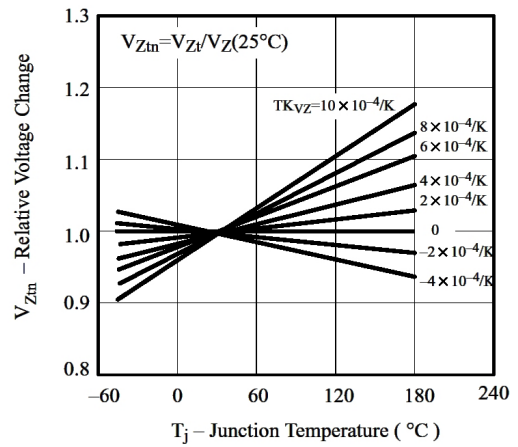

Figure 4. Typical Change of Working Voltage Vs. Junction Temperature

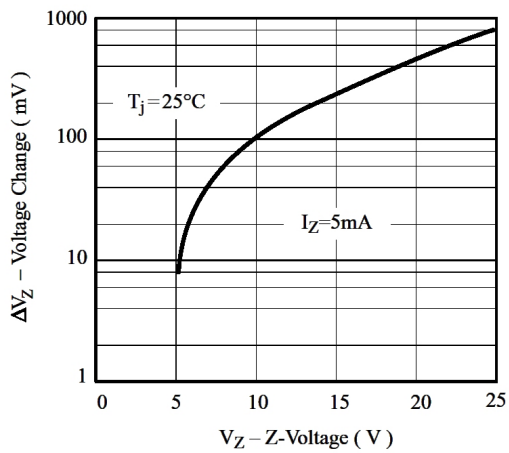

Figure 2. Typical Change of Working Voltage under Operating Conditions at  $T_{amb}=25^\circ\text{C}$

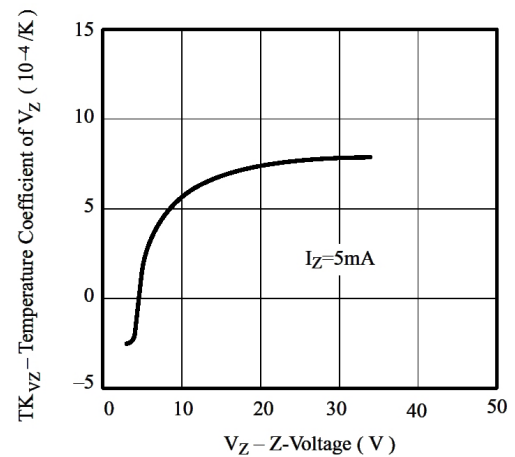

Figure 5. Temperature Coefficient of  $V_Z$  vs. Z-Voltage

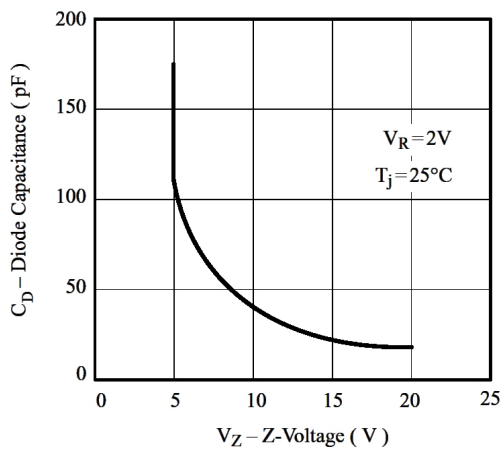

Figure 3. Diode Capacitance vs. Z-voltage

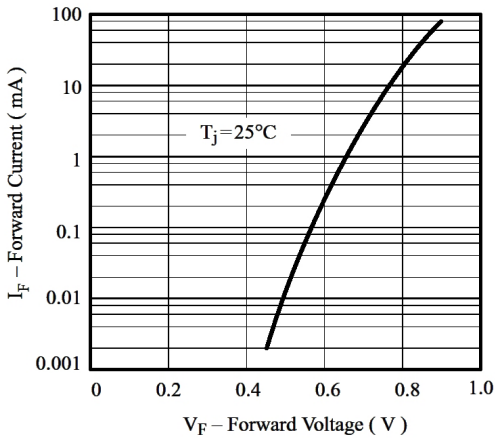

Figure 6. Forward Current vs. Forward Voltage

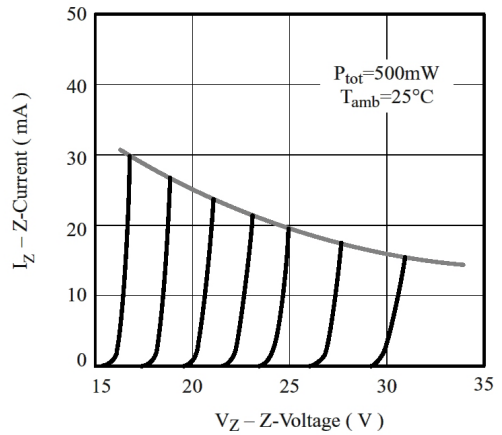

Figure 8. Z-Current vs. Z-Voltage

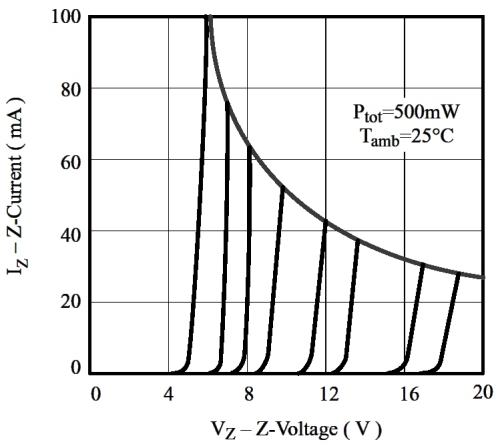

Figure 7. Z-Current vs. Z-Voltage

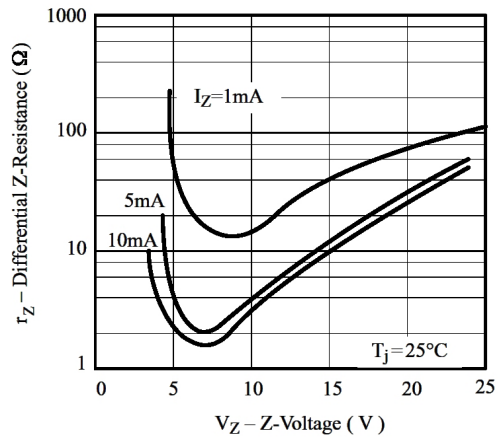

Figure 9. Differential Z-Resistance Vz vs. Z-Voltage

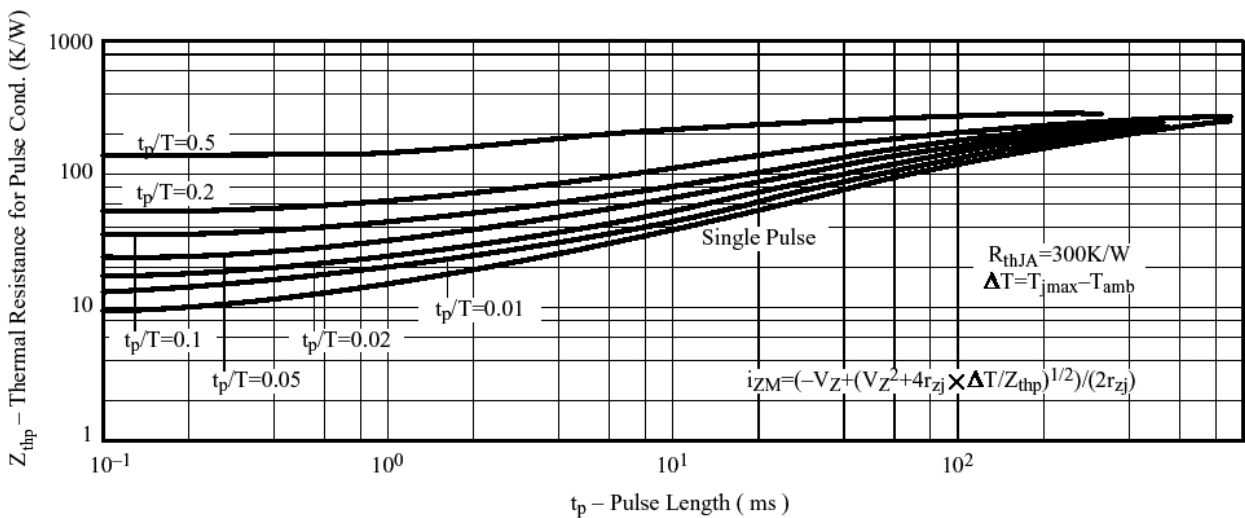
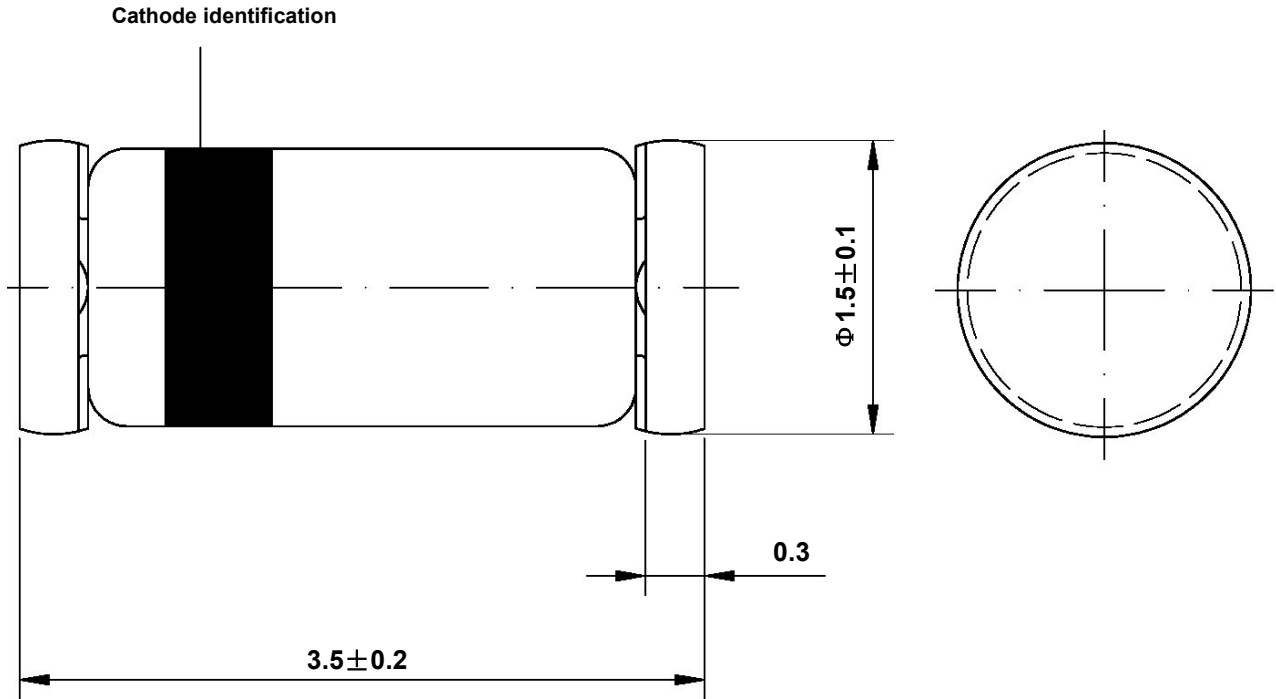

Figure 10. Thermal Response

**Dimensions in mm**



Glass Case  
Mini Melf / SOD 80  
JEDEC DO 213 AA