

### Features

- 12 PINS.
- HIGH LUMINOUS INTENSITY.
- LOW POWER CONSUMPTION.
- WIDE VIEWING ANGLE.
- CATEGORIZED FOR LUMINOUS INTENSITY.
- EXCELLENT ON/OFF CONTRAST.
- EASY MOUNTING ON P.C. BOARD OR SOCKETS.
- SOLID STATE RELIABILITY.

DLA/6 SERIES

DLC/6 SERIES

### Description

The High Efficiency Red and Orange source color devices are made with Gallium Arsenide Phosphide on Gallium Phosphide Orange Light Emitting Diode.

The Green and Super Bright Green source color devices are made with Gallium Phosphide Green Light Emitting Diode.

The Yellow source color devices are made with Gallium Arsenide Phosphide on Gallium Phosphide Yellow Light Emitting Diode.

The Super Bright Red source color devices are made with Gallium Aluminum Arsenide Red Light Emitting Diode.

### Package Dimensions

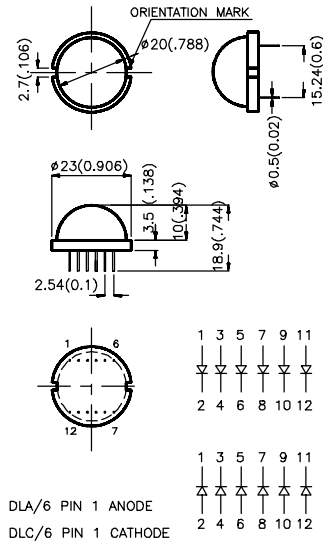

### Notes:

1. All dimensions are in millimeters (inches).
2. Tolerance is  $\pm 0.25(0.01)$  unless otherwise noted.
3. Lead spacing is measured where the lead emerge package.
4. Specifications are subjected to change without notice.

### Selection Guide

Part No.	Dice	Lens Type	Iv (mcd) @ 10 mA		Viewing Angle
			Min.	Typ.	
DLA/6ID DLC/6ID	HIGH EFFICIENCY RED (GaAsP/GaP)	RED DIFFUSED	12	50	120°
DLA/6GD DLC/6GD	GREEN (GaP)	GREEN DIFFUSED	20	80	120°
DLA/6YD DLC/6YD	YELLOW (GaAsP/GaP)	YELLOW DIFFUSED	12	50	120°
DLA/6SRD DLC/6SRD	SUPER BRIGHT RED (GaAlAs)	RED DIFFUSED	*70	*200	120°
DLA/6SGD DLC/6SGD	SUPER BRIGHT GREEN (GaP)	GREEN DIFFUSED	*100	*400	120°

### Notes:

1.  $\theta_{1/2}$  is the angle from optical centerline where the luminous intensity is 1/2 the optical centerline value.
2. \* Luminous intensity with asterisk is measured at 20mA.

## Electrical / Optical Characteristics at T<sub>A</sub>=25°C

Symbol	Parameter	Device	Typ.	Max.	Units	Test Conditions
$\lambda_{peak}$	Peak Wavelength	High Efficiency Red Green Yellow Super Bright Red Super Bright Green	625 565 590 660 565		nm	IF=20mA
$\Delta\lambda_{1/2}$	Spectral Line Halfwidth	High Efficiency Red Green Yellow Super Bright Red Super Bright Green	45 30 35 20 30		nm	IF=20mA
C	Capacitance	High Efficiency Red Green Yellow Super Bright Red Super Bright Green	12 45 10 95 45		pF	VF=0V;f=1MHz
V <sub>F</sub>	Forward Voltage	High Efficiency Red Green Yellow Super Bright Red Super Bright Green	2.0 2.2 2.1 1.85 2.2	2.5 2.5 2.5 2.5 2.5	V	IF=20mA
I <sub>r</sub>	Reverse Current	All		10	uA	VR = 5V

## Absolute Maximum Ratings at T<sub>A</sub>=25°C

Parameter	High Efficiency Red	Green	Yellow	Super Bright Red	Super Bright Green	Units
Power dissipation	105	105	105	100	105	mW
DC Forward Current	30	25	30	30	25	mA
Peak Forward Current [1]	150	150	150	150	150	mA
Reverse Voltage	5	5	5	5	5	V
Operating/Storage Temperature	-40°C To +85°C					
Lead Soldering Temperature [2]	260°C For 5 Seconds					

Notes:

- 1/10 Duty Cycle, 0.1ms Pulse Width.
- 4mm below package base.

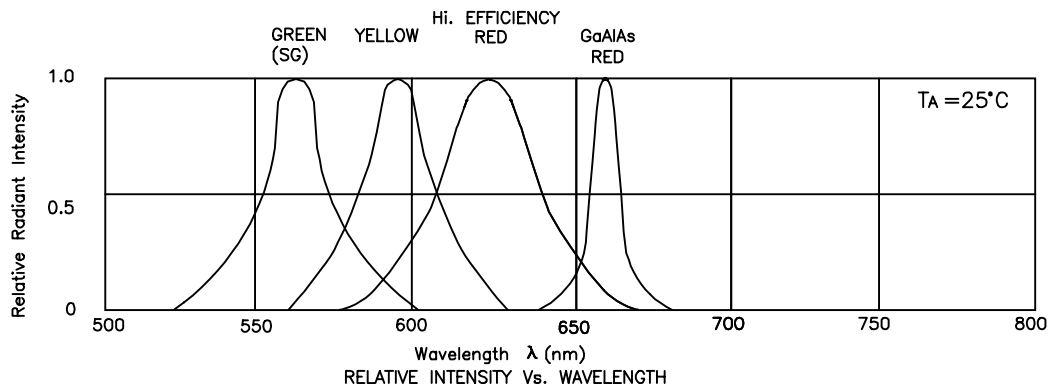

## High Efficiency Red DLA/6ID,DLC/6ID

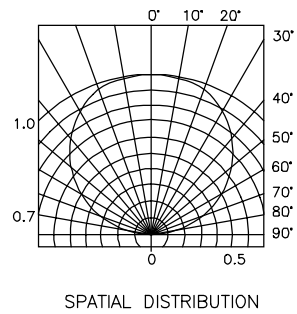
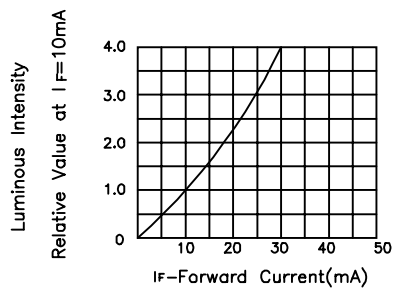
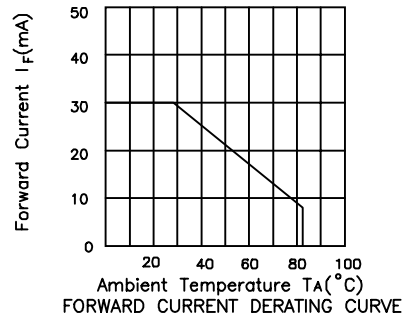
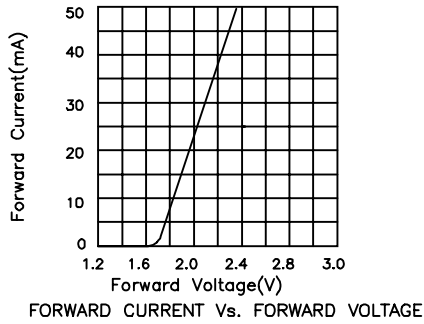

## Green DLA/6GD,DLC/6GD

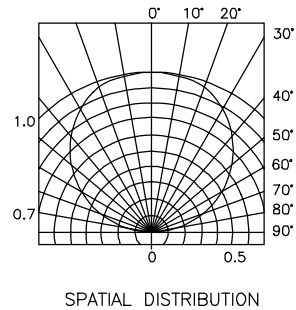
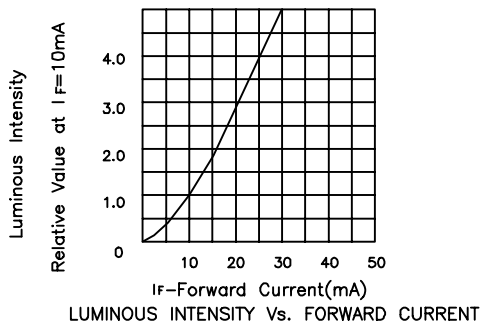
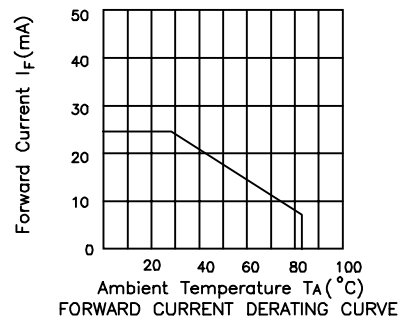
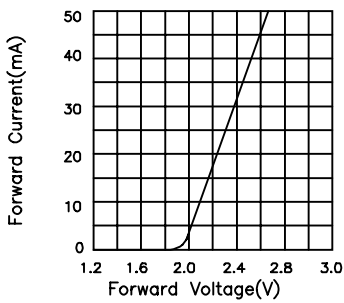

## Yellow DLA/6YD,DLC/6YD

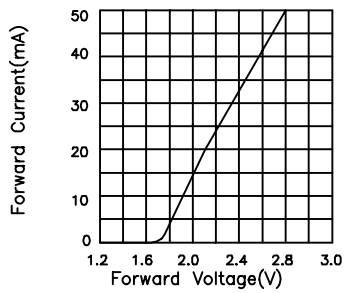

FORWARD CURRENT Vs. FORWARD VOLTAGE

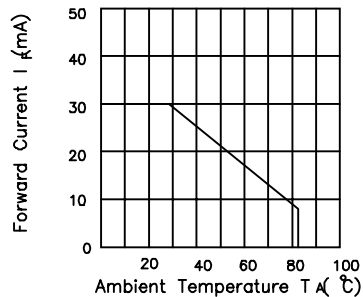

FORWARD CURRENT DERATING CURVE

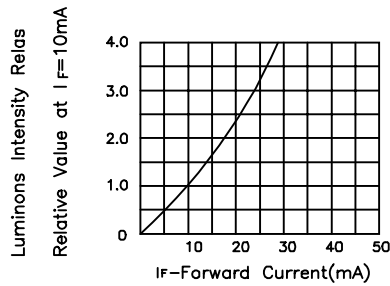

LUMINOUS INTENSITY Vs. FORWARD CURRENT

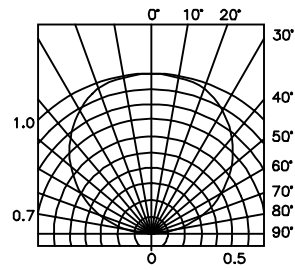

SPATIAL DISTRIBUTION

## Super Bright Red DLA/6SRD,DLC/6SRD

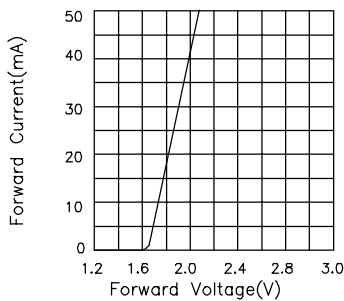

FORWARD CURRENT Vs. FORWARD VOLTAGE

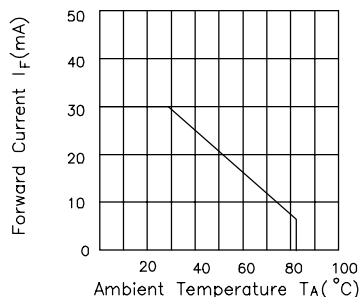

FORWARD CURRENT DERATING CURVE

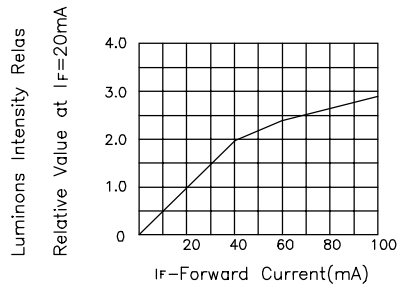

LUMINOUS INTENSITY Vs. FORWARD CURRENT

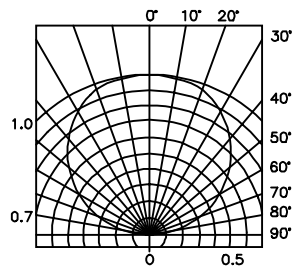

SPATIAL DISTRIBUTION

## Super Bright Green DLA/6SGD,DLC/6SGD

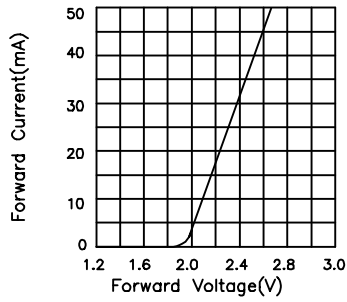

FORWARD CURRENT Vs. FORWARD VOLTAGE

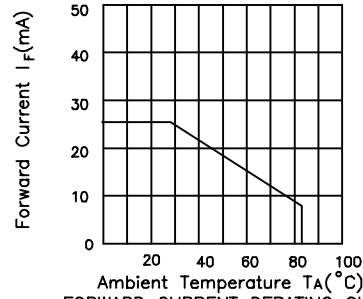

FORWARD CURRENT DERATING CURVE

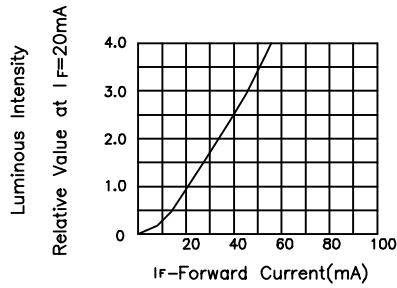

LUMINOUS INTENSITY Vs. FORWARD CURRENT

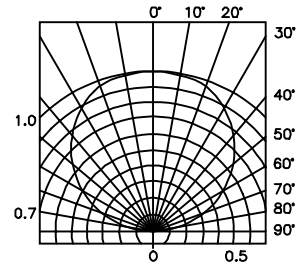

SPATIAL DISTRIBUTION